

BUILDING
WITH **EARTH**

Design and Technology of a Sustainable Architecture
by Gernot Minke

BIRKHÄUSER

Building with Earth

Gernot Minke

Building with Earth

Design and Technology of a Sustainable Architecture

Birkhäuser – Publishers for Architecture
Basel · Berlin · Boston

I The technology of earth building

1 Introduction 11

- History 11
- Earth as a building material: the essentials 13
- Improving indoor climate 15
- Prejudices against earth as a building material 18

2 The properties of earth as a building material 19

- Composition 19
- Tests used to analyse the composition of loam 21
- Effects of water 24
- Effects of vapour 29
- Influence of heat 31
- Strength 32
- pH-value 35
- Radioactivity 35
- Shelter against high-frequency electromagnetic radiation 35

3 Preparing of loam 36

- Soaking, crushing and mixing 36
- Sieving 38
- Mechanical slurring 38
- Water Curing 38
- Thinning 38

4 Improving the earth's characteristics by special treatment or additives 39

- Reduction of shrinkage cracks 39
- Stabilisation against water erosion 40
- Enhancement of binding force 42
- Increasing compressive strength 43
- Strength against abrasion 47
- Increasing thermal insulation 47

5 Rammed earthworks 52

- Formwork 53
- Tools 54
- Method of construction 55
- Shaping of openings 55
- New wall construction techniques 56
- Rammed earth domes 59
- Drying 59
- Labour input 60
- Thermal insulation 60
- Surface treatment 60

6 Working with earthen blocks 61

- History 61
- Production of earth blocks 62
- Material composition 65
- Laying earth blocks 65
- Surface treatment 66
- Fixing fasteners to walls 67
- Lightweight loam blocks 67
- Special acoustic green bricks 68

7 Large blocks and prefabricated panels 69

- Large blocks 69
- Prefabricated wall panels 70
- Floor slabs 70
- Floor tiles 71
- Extruded loam slabs 71

8 Direct forming with wet loam 72

- Traditional wet loam techniques 72
- The "Dünne loam loaf" technique 74
- The *stranglehm* technique 75

9 Wet loam infill in skeleton structures 80

- Thrown loam 80
- Sprayed loam 80
- Rolls and bottles of straw loam 81
- Lightweight loam infill 82
- Infill with *stranglehm* and earth-filled hoses 82

10 Tamped, poured or pumped lightweight loam 83

- Formwork 83
- Tamped lightweight straw loam walls 83
- Tamped lightweight wood loam walls 84
- Tamped, poured or pumped lightweight mineral loam walls 85
- Pumped lightweight mineral loam floors 88
- Loam-filled hollow blocks 89
- Loam-filled hoses 90

11 Loam plasters 92

- Preparation of ground 92
- Composition of loam plaster 92
- Guidelines for plastering earth walls 94
- Sprayed plaster 95
- Lightweight mineral loam plaster 95
- Thrown plaster 95
- Plastered straw bale houses 95
- Wet formed plaster 96
- Protection of corners 96

12 Weather protection of loam surfaces 98

- Consolidating the surface 98
- Paints 98
- Making surfaces water-repellent 101
- Lime plasters 101
- Shingles, planks and other covers 103
- Structural methods 103

13 Repair of loam components 104

- The occurrence of damage in loam components 104
- Repair of cracks and joints with loam fillers 104
- Repair of cracks and joints with other fillers 105
- Repairing larger areas of damage 105
- Retrofitting thermal insulation with lightweight loam 106

14 Designs of particular building elements 107

- Joints 107
- Particular wall designs 108
- Intermediate floors 110
- Rammed earth floorings 112
- Inclined roofs filled with lightweight loam 115
- Earth-covered roofs 115
- Earth block vaults and domes 117
- Earthen storage wall in winter gardens 131
- Loam in bathrooms 132
- Built-in furniture and sanitary objects from loam 133
- Wall heating systems 134
- Passive solar wall heating system 134

15 Earthquake-resistant building 135

- Structural measures 136
- Openings for doors and windows 140
- Bamboo-reinforced rammed earth walls 141
- Domes 144
- Vaults 145
- Textile walls with loam infill 147

- Residence and studio at Gallina Canyon,
New Mexico, USA 162
- Residence at Des Montes, near Taos,
New Mexico, USA 164
- Casita Nuaanarpoq at Taos, New Mexico, USA 166
- Residence and office at Bowen Mountain,
New South Wales, Australia 167
- Vineyard Residence at Mornington Peninsula,
Victoria, Australia 168
- Residence, Helensville, New Zealand 170
- Residence, São Francisco Xavier, Brazil 172

Cultural, Educational and Sacral Buildings

- Panafrican Institute for Development, Ouagadougou,
Burkina Faso 174
- Office building, New Delhi, India 176
- School at Solvig, Järna, Sweden 178
- Kindergarten, Sorsum, Germany 180
- Cultural Centre, La Paz, Bolivia 182
- Mosque, Wabern, Germany 183
- Druk White Lotus School, Ladakh, India 184
- Mii amo Spa at Sedona, Arizona, USA 186
- Tourist resort at Baird Bay, Eyre Peninsula,
South Australia 188
- Charles Sturt University at Thurgoona,
New South Wales, Australia 189
- Youth Centre at Spandau, Berlin, Germany 190
- Chapel of Reconciliation, Berlin, Germany 192
- Center of Gravity Foundation Hall at Jemez Springs,
New Mexico, USA 194
- Future prospects 196
- Measures 197
- Bibliographical references 198
- Acknowledgements 199
- Illustration credits 199

II Built examples

Residences

- Two semi-detached houses, Kassel, Germany 150
- Residence cum office, Kassel, Germany 153
- Farmhouse, Wazipur, India 156
- Honey House at Moab, Utah, USA 157
- Three-family house, Stein on the Rhine,
Switzerland 158
- Residence, La Paz, Bolivia 160
- Residence, Turku, Finland 161

Preface

Written in response to an increasing worldwide interest in building with earth, this handbook deals with earth as a building material, and provides a survey of all of its applications and construction techniques, including the relevant physical data, while explaining its specific qualities and the possibilities of optimising them. No theoretical treatise, however, can substitute for practical experience involving actually building with earth. The data and experiences and the specific realisations of earth construction contained in this volume may be used as guidelines for a variety of construction processes and possible applications by engineers, architects, entrepreneurs, craftsmen and public policy-makers who find themselves attempting, either from desire or necessity, to come to terms with humanity's oldest building material.

Earth as a building material comes in a thousand different compositions, and can be variously processed. Loam, or clayey soil, as it is referred to scientifically, has different names when used in various applications, for instance rammed earth, soil blocks, mud bricks or adobe.

This book documents the results of experiments and research conducted continuously at the Forschungslabor für Experimentelles Bauen (Building Research Institute) at the University of Kassel in Germany since 1978. Moreover, the specialised techniques which the author developed and the practical

experience he gathered in the course of designing earth buildings in a number of countries have also found their way into this book.

This volume is loosely based on the German publication *Das neue Lehm-Bau-Handbuch* (Publisher: Ökobuch Verlag, Staufen), first published in 1994 and now in its sixth edition. Of this publication a Spanish and a Russian edition have also appeared.

While this is first and foremost a technical book, the introductory chapter also provides the reader with a short survey on the history of earth architecture. In addition it describes the historical and future roles of earth as a building material, and lists all of the significant characteristics that distinguish earth from common industrialised building materials. A major recent discovery, that earth can be used to balance indoor climate, is explained in greater detail.

The book's final chapter deserves special mention insofar as it depicts a number of representative earth buildings from various regions of the world. These constructions demonstrate the impressive versatility of earth architecture and the many different uses of the building material earth.

Kassel, February 2006
Gernot Minke

Next page Minaret of the Al-Mihdar Mosque in Tarim, Yemen; it is 38 m high and built of handmade adobes



I The technology of earth building

1 Introduction



1.1 Storage rooms,
temple of Ramses II,
Gourna, Egypt

In nearly all hot-arid and temperate climates, earth has always been the most prevalent building material. Even today, one third of the human population resides in earthen houses; in developing countries this figure is more than one half. It has proven impossible to fulfil the immense requirements for shelter in the developing countries with industrial building materials, i.e. brick, concrete and steel, nor with industrialised construction techniques. Worldwide, no region is endowed with the productive capacity or financial resources needed to satisfy this demand. In the developing countries, requirements for shelter can be met only by using local building materials and relying on do-it-yourself construction techniques. Earth is the most important natural building material, and it is available in most regions of the world. It is frequently obtained direct-

ly from the building site when excavating foundations or basements. In the industrialised countries, careless exploitation of resources and centralised capital combined with energy-intensive production is not only wasteful; it also pollutes the environment and increases unemployment. In these countries, earth is being revived as a building material.

Increasingly, people when building homes demand energy- and cost-effective buildings that emphasise a healthy, balanced indoor climate. They are coming to realise that mud, as a natural building material, is superior to industrial building materials such as concrete, brick and lime-sandstone.

Newly developed, advanced earth building techniques demonstrate the value of earth not only in do-it-yourself construction, but also for industrialised construction involving contractors.

This handbook presents the basic theoretical data concerning this material, and it provides the necessary guidelines, based on scientific research and practical experience, for applying it in a variety of contexts.

History

Earth construction techniques have been known for over 9000 years. Mud brick (adobe) houses dating from 8000 to 6000 BC have been discovered in Russian Turkistan (Pumpelly, 1908). Rammed earth foundations dating from ca. 5000 BC have been



1.2 Fortified city,
Draa valley, Morocco
1.3 Citadel of Bam,
Iran, before earth-
quake of Dec. 2003

1.2

discovered in Assyria. Earth was used as the building material in all ancient cultures, not only for homes, but for religious buildings as well. Illustration 1.1 shows vaults in the Temple of Ramses II at Gournah, Egypt, built from mud bricks 3200 years ago. Illustration 1.2 shows the citadel of Bam in Iran, parts of which are ca. 2500 years old; 1.3 shows a fortified city in the Draa valley in Morocco, which is around 250 years old.

The 4000-year-old Great Wall of China was originally built solely of rammed earth; only a later covering of stones and bricks gave it the appearance of a stone wall. The core of the Sun Pyramid in Teotihuacan, Mexico, built between the 300 and 900 AD, consists of approximately 2 million tons of rammed earth.

Many centuries ago, in dry climatic zones where wood is scarce, construction techniques were developed in which buildings were covered with mud brick vaults or domes without formwork or support during construction. Illustration 1.6 shows the bazaar quarter of Sirdjan in Persia, which is covered by such domes and vaults. In China, twenty million people live in underground houses or caves that were dug in the silty soil.

Bronze Age discoveries have established that in Germany earth was used as an infill in timber-framed houses or to seal walls made of tree trunks. Wattle and daub was also used. The oldest example of mud brick



1.3

walls in northern Europe, found in the Heuneburg Fort near Lake Constance, Germany (1.8) dates back to the 6th century BC. We know from the ancient texts of Pliny that there were rammed earth forts in Spain by the end of the year 100 BC.

In Mexico, Central America and South America, adobe buildings are known in nearly all pre-Columbian cultures. The rammed earth technique was also known in many areas, while the Spanish conquerors brought it to others. Illustration 1.7 shows a rammed earth finca in the state of São Paulo, Brazil, which is 250 years old.

In Africa, nearly all early mosques are built from earth. Illustration 1.9 shows one from



1.4



1.5

- 1.4 Large Mosque, Djenne, Mali, built 1335
- 1.5 Mosque, Kashan, Iran
- 1.6 Bazaar, Sirdjan, Iran

the 12th century, 1.4 and 1.5 show later examples in Mali and Iran.

In the Medieval period (13th to 17th centuries), earth was used throughout Central Europe as infill in timber-framed buildings, as well as to cover straw roofs to make them fire-resistant.

In France, the rammed earth technique, called *terre pisé*, was widespread from the 15th to the 19th centuries. Near the city of Lyon, there are several buildings that are more than 300 years old and are still inhabited. In 1790 and 1791, Francois Cointeraux published four booklets on this technique that were translated into German two years later (Cointeraux, 1793). The technique came to be known all over Germany and in neighbouring countries through Cointeraux, and through David Gilly, who wrote the famous *Handbuch der Lehmbackkunst* (Gilly, 1787), which describes the rammed earth technique as the most advantageous earth construction method.

In Germany, the oldest inhabited house with rammed earth walls dates from 1795 (1.10). Its owner, the director of the fire department, claimed that fire-resistant houses could be built more economically using this technique, as opposed to the usual timber frame houses with earth infill.

The tallest house with solid earth walls in Europe is at Weilburg, Germany. Completed in 1828, it still stands (1.11). All ceilings and

the entire roof structure rest on the solid rammed earth walls that are 75 cm thick at the bottom and 40 cm thick at the top floor (the compressive force at the bottom of the walls reaches 7,5 kg/cm²). Illustration 1.12 shows the facades of other rammed earth houses at Weilburg, built around 1830.

Earth as a building material: the essentials

Earth, when used as a building material, is often given different names. Referred to in scientific terms as loam, it is a mixture of clay, silt (very fine sand), sand, and occasionally larger aggregates such as gravel or stones.

When speaking of handmade unbaked bricks, the terms “mud bricks” or “adobes” are usually employed; when speaking of compressed unbaked bricks, the term “soil blocks” is used. When compacted within a formwork, it is called “rammed earth”. Loam has three disadvantages when compared to common industrialised building materials:

1 Loam is not a standardised building material

Depending on the site where the loam is dug out, it will be composed of differing amounts and types of clay, silt, sand and aggregates. Its characteristics, therefore, may differ from site to site, and the preparation of the correct mix for a specific application may also differ. In order to judge its characteristics and alter these, when necessary, by applying additives, one needs to know the specific composition of the loam involved.

2 Loam mixtures shrink when drying

Due to evaporation of the water used to prepare the mixture (moisture is required to activate its binding strength and to achieve workability), shrinkage cracks will occur. The linear shrinkage ratio is usually between 3% and 12% with wet mixtures (such as those used for mortar and mud bricks), and between 0.4% and 2% with drier mixtures



1.6

(used for rammed earth, compressed soil blocks). Shrinkage can be minimised by reducing the clay and the water content, by optimising the grain size distribution, and by using additives (see p. 39).

3 Loam is not water-resistant

Loam must be sheltered against rain and frost, especially in its wet state. Earth walls can be protected by roof overhangs, damp-proof courses, appropriate surface coatings etc. (see p. 40).

On the other hand, loam has many advantages in comparison to common industrial building materials:

1 Loam balances air humidity

Loam is able to absorb and desorb humidity faster and to a greater extent than any other building material, enabling it to balance indoor climate. Experiments at the Forschungslabor für Experimentelles Bauen (Building Research Laboratory, or BRL) at the University of Kassel, Germany, demonstrated that when the relative humidity in a room was raised suddenly from 50% to 80%, unbaked bricks were able, in a two-day period to absorb 30 times more humidity than baked bricks. Even when standing in



1.9



1.7

a climatic chamber at 95% humidity for six months, adobes do not become wet or lose their stability; nor do they exceed their equilibrium moisture content, which is about 5% to 7% by weight. (The maximum humidity a dry material can absorb is called its "equilibrium moisture content").

Measurements taken in a newly built house in Germany, all of whose interior and exterior walls are from earth, over a period of eight years, showed that the relative humidity in this house was a nearly constant 50% throughout the year. It fluctuated by only 5% to 10%, thereby producing healthy living condition with reduced humidity in summer and elevated humidity in winter. (For more details, see p. 15).

2 Loam stores heat

Like all heavy materials, loam stores heat. As a result, in climatic zones with high diurnal temperature differences, or where it becomes necessary to store solar heat gain by passive means, loam can balance indoor climate.

3 Loam saves energy and reduces environmental pollution

The preparation, transport and handling of loam on site requires only ca. 1% of the energy needed for the production, transport and handling of baked bricks or reinforced concrete. Loam, then, produces virtually no environmental pollution.



1.8

1.7 Rammed earth finca, São Paulo, Brazil

1.8 Reconstruction of mud-brick wall, Heuneburg, Germany, 6th century BC

1.9 Mosque at Nando, Mali, 12th century



1.11



1.12

1.10 Rammed earth house, Meldorf, Germany, 1795

1.11 Rammed earth house, Weillburg, Germany, 1828

1.12 Rammed earth houses, Weillburg, Germany, about 1830

4 Loam is always reusable

Unbaked loam can be recycled an indefinite number of times over an extremely long period. Old dry loam can be reused after soaking in water, so loam never becomes a waste material that harms the environment.

5 Loam saves material and transportation costs

Clayey soil is often found on site, so that the soil excavated for foundations can then be used for earth construction. If the soil contains too little clay, then clayey soil must be added, whereas if too much clay is present, sand is added.

The use of excavated soil means greatly reduced costs in comparison with other building materials. Even if this soil is transported from other construction sites, it is usually much cheaper than industrial building materials.

6 Loam is ideal for do-it-yourself construction

Provided the building process is supervised by an experienced individual, earth construction techniques can usually be executed by non-professionals. Since the processes involved are labour-intensive and require only inexpensive tools and machines, they are ideal for do-it-yourself building.

7 Loam preserves timber and other organic materials

Owing to its low equilibrium moisture content of 0.4% to 6% by weight and its high capillarity, loam conserves the timber elements that remain in contact with it by keeping them dry. Normally, fungi or insects will not damage such wood, since insects need a minimum of 14% to 18% humidity to maintain life, and fungi more than 20% (Möhler 1978, p. 18). Similarly, loam can preserve small quantities of straw that are mixed into it.

However, if lightweight straw loam with a density of less than 500 to 600 kg/m³ is used, then the loam may lose its preservative capacity due to the high capillarity of the straw when used in such high propor-



1.10

tions. In such cases, the straw may rot when remaining wet over long periods (see p. 83).

8 Loam absorbs pollutants

It is often maintained that earth walls help to clean polluted indoor air, but this has yet to be proven scientifically. It is a fact that earth walls can absorb pollutants dissolved in water. For instance, a demonstration plant exists in Ruhleben, Berlin, which uses clayey soil to remove phosphates from 600 m³ of sewage daily. The phosphates are bound by the clay minerals and extracted from the sewage. The advantage of this procedure is that since no foreign substances remain in the water, the phosphates are converted into calcium phosphate for reuse as a fertiliser.

Improving indoor climate

In moderate to cold climates, people usually spend about 90% of their time in enclosed spaces, so indoor climate is a crucial factor in well-being. Comfort depends upon the temperature, movement, humidity, radiation to and from surrounding objects, and pollution content of the air contained in a given room.

Although occupants immediately become aware when room temperatures are too high or too low, the negative impacts of excessively elevated or reduced humidity levels are not common knowledge. Air humidity in contained spaces has a significant impact on the health of inhabitants, and earth has the ability to balance indoor humidity like no other building material. This fact, only recently investigated, is described in detail later in this section.

Air humidity and health

Research performed by Grandjean (1972) and Becker (1986) has shown that a relative humidity of less than 40% over a long period may dry out the mucous membrane, which can decrease resistance to colds and related diseases. This is so because normally the mucous membrane of the epithelial tissue within the trachea absorbs dust, bacteria, viruses etc. and returns them to the mouth by the wavelike movement of the epithelial hair. If this absorption and transportation system is disturbed by drying, then foreign bodies can reach the lungs and may cause health problems (see 1.13).

A high relative humidity of up to 70% has many positive consequences: it reduces the fine dust content of the air, activates the protection mechanisms of the skin against microbes, reduces the life of many bacteria and viruses, and reduces odour and static charge on the surfaces of objects in the room.

A relative humidity of more than 70% is normally experienced as unpleasant, probably because of the reduction of oxygen intake by the blood in warm-humid conditions. Increasing rheumatic pains are observed in cold humid air. Fungus formation increases significantly in closed rooms when the humidity rises above 70% or 80%. Fungus spores in large quantities can lead to various kinds of pain and allergies. From these considerations, it follows that the humidity content in a room should be a minimum of 40%, but not more than 70%.

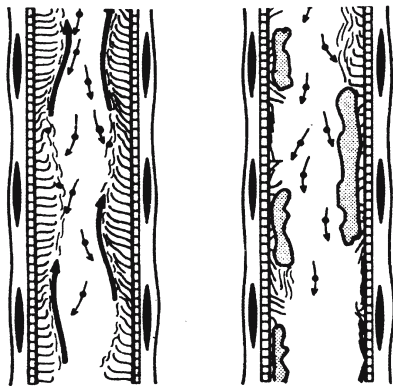

1.13

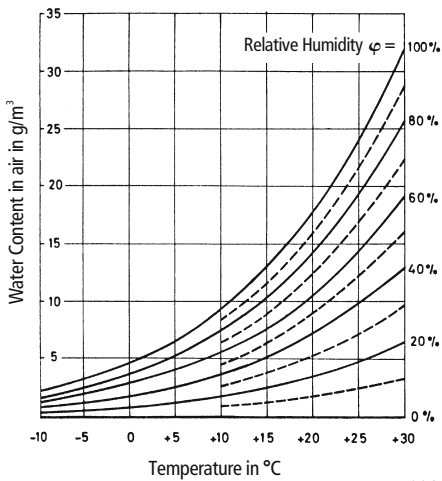

1.14

The impact of air exchange on air humidity

In moderate and cold climates, when the outside temperatures are much lower than inside temperatures, the greater degree of fresh air exchange may make indoor air so dry that negative health effects can result. For example, if outside air with a temperature of 0°C and 60% relative humidity enters a room and is heated to 20°C, its relative humidity decreases to less than 20%. Even if the outside air (temperature 0°C) had 100% humidity level and was warmed up to 20°C, its relative humidity would still drop to less than 30%. In both cases, it becomes necessary to raise the humidity as soon as possible in order to attain healthy and comfortable conditions. This can be done by regulating the humidity that is released by walls, ceilings, floors and furniture (see 1.14).

The balancing effect of loam on humidity

Porous materials have the capacity to absorb humidity from the ambient air and to desorb humidity into the air, thereby achieving humidity balance in indoor climates. The equilibrium moisture content depends on the temperature and humidity of the ambient air (see p. 29) and illustration 2.29). The effectiveness of this balancing process also depends upon the speed of the absorption or desorption. Experiments conducted at the BRL show, for instance, that the first 1.5-cm-thick layer of a mud brick wall is able to absorb about 300 g of

1.13 Section through trachea with sane mucous membrane (left) and dried out one (right) (Becker, 1986)

1.14 Carrier Diagram

1.15 Absorption of samples, 15 mm thick, at a temperature of 21°C and a sudden increase of humidity from 50% to 80%

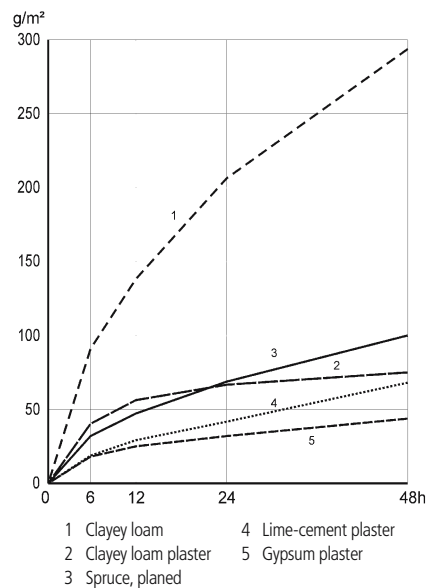
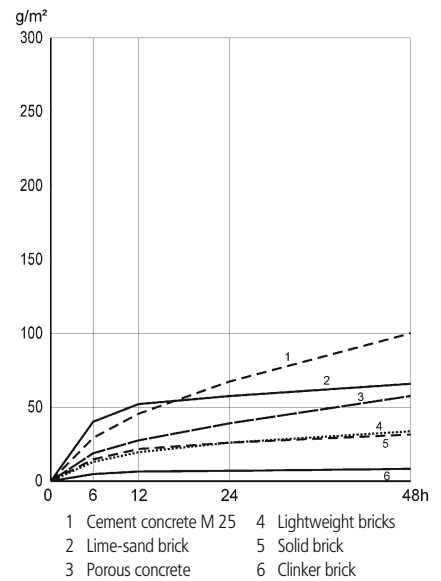

1.15

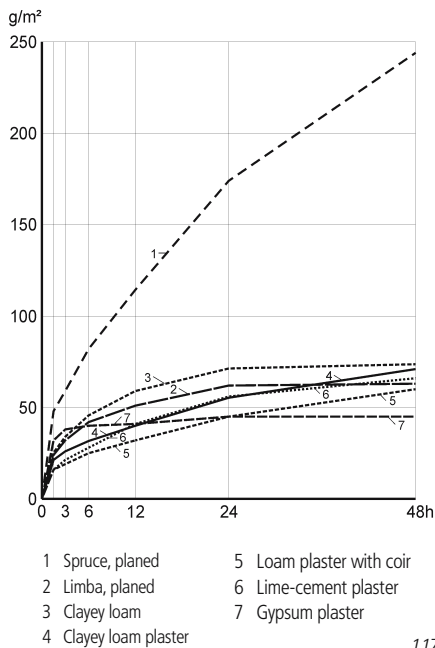

1.17

1.16 Absorption curves of 11.5-cm-thick interior walls with two sides exposed at a temperature of 21°C after a sudden rise in humidity from 50% to 80%
 1.17 Absorption curves of 15-mm-thick samples, one side exposed, at a temperature of 21°C after a sudden rise in humidity from 30% to 70%
 1.18 Effect of the thickness of loam layers at a temperature of 21°C on their rate of absorption after a sudden rise in humidity from 50% to 80%

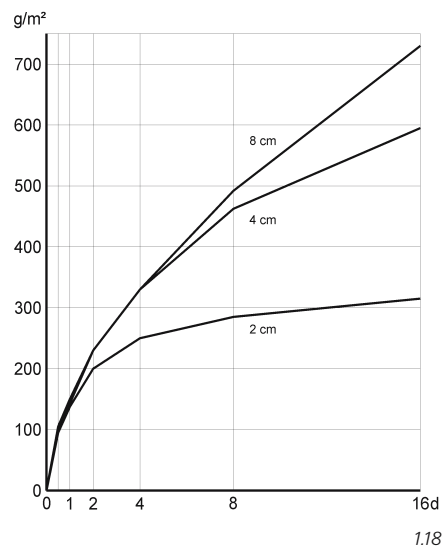

1.18

water per m² of wall surface in 48 hours if the humidity of the ambient air is suddenly raised from 50% to 80%. However, lime-sandstone and pinewood of the same thickness absorb only about 100 g/m², plaster 26 to 76 g/m², and baked brick only 6 to 30 g/m² in the same period (1.15).

The absorption curves from both sides of 11.5-cm-thick unplastered walls of different materials over 16 days are shown in 1.16. The results show that mud bricks absorb 50 times as much moisture as solid bricks baked at high temperatures. The absorption rates of 1.5-cm-thick samples, when humidity was raised from 30% to 70%, are shown in 1.17.

The influence of the thickness of a clayey soil on absorption rates is shown in 1.18. Here we see that when humidity is raised suddenly from 50% to 80%, only the upper 2 cm absorbs humidity within the first 24 hours, and that only the upper layer 4 cm in thickness is active within the first four days. Lime, casein and cellulose glue paints reduce this absorption only slightly, whereas coatings of double latex and single linseed oil can reduce absorption rates to 38% and 50% respectively, as seen in 1.19.

In a room with a floor area of 3 x 4 m, a height of 3 m, and a wall area of 30 m² (after subtracting doors and windows), if indoor air humidity were raised from 50% to 80%, unplastered mud brick walls would absorb about 9 litres of water in 48 hours.

(If the humidity were lowered from 80% to 50%, the same amount would be released). The same walls, if built from solid baked bricks, would absorb only about 0.9 litres of water in the same period, which means they are inappropriate for balancing the humidity of rooms.

Measurements taken over a period of five years in various rooms of a house built in Germany in 1985, all of whose exterior and interior walls were built of earth, showed that the relative humidity remained nearly constant over the years, varying from 45% to 55%. The owner wanted higher humidity levels of 50% to 60% only in the bedroom. It was possible to maintain this higher level (which is healthier for people who tend to get colds or flues) by utilising the higher humidity of the adjacent bathroom. If bedroom humidity decreased too much, the door to the bathroom was opened after showering, recharging the bedroom walls with humidity.

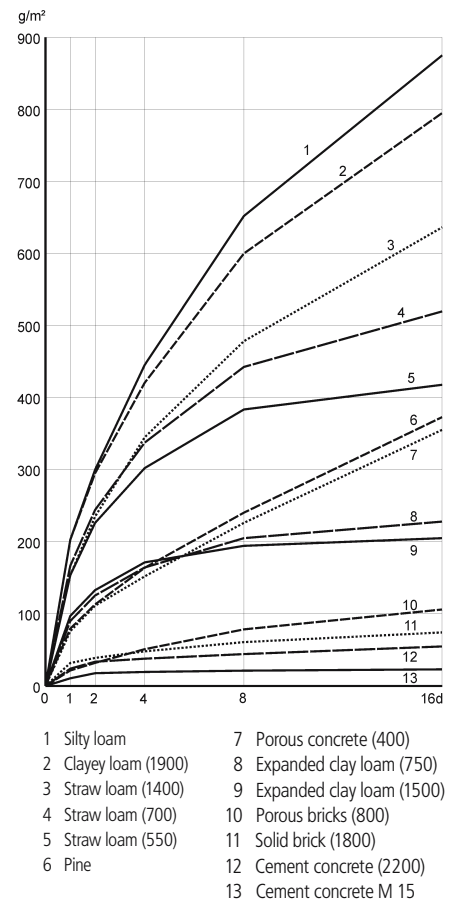

1.16

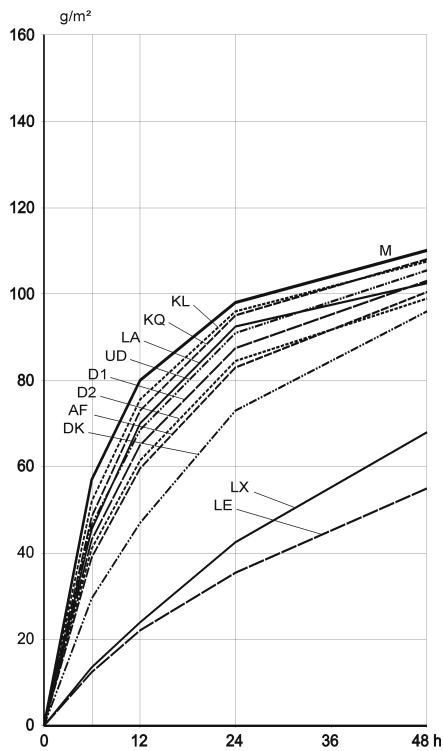

- M Silty loam, 2 Sand without coating
- KQ 2x 1 Lime : 1 Quark : 1.7 Water
- KL 2x Chalk cellulose glue paint
- LE 1x Double-boiled linseed oil
- D2 2x Biofa dispersible paint
- LA 1x Biofa glaze with primer
- AF 2x Acrylic paint
- DK 2x Synthetic dispersion paint exterior
- LX 2x Latex
- UD 2x Dispersion paint without solvent
- D1 2x Dispersion paint for interior

1.19

1.19 Influence of coatings on 1.5-cm-thick, one-side-exposed loam plasters at a temperature of 21°C (clay 4%, silt 25%, sand 71%) after a sudden rise in humidity from 50% to 80%. Thickness of coating is $100 \pm 10 \mu\text{m}$.

1.20 Influence of different aggregates on the absorption of humidity. Same conditions as mentioned in 1.19

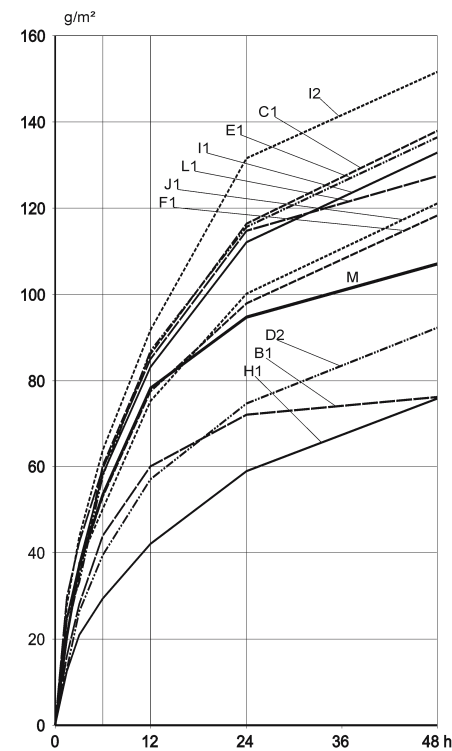

- M Loam plaster without aggregate
- I2 with 2.0% coconut fibres
- C1 with 2.0% cellulose fibres
- E1 with 2.0% water glass
- I1 with 1.0% coconut fibres
- L1 with 3.0% saw dust
- J1 with 2.0% wheat straw
- F1 with 3.0% cement
- D2 with 2.0% boiled rye flour
- B1 with 0.5% cellulose glue
- H1 with 6.0% casein/lime

1.20

Prejudices against earth as a building material

Owing to ignorance, prejudices against loam are still widespread. Many people have difficulty conceiving that a natural building material such as earth need not be processed and that, in many cases, the excavation for foundations provides a material that can be used directly in building. The following reaction by a mason who had to build an adobe wall is characteristic: "This is like medieval times; now we have to dirty our hands with all this mud." The same mason, happily showing his hands after working with adobes for a week, said, "Have you ever seen such smooth mason's hands? The adobes are a lot of fun to handle as there are no sharp corners."

The anxiety that mice or insects might live in earth walls is unfounded when these are solid. Insects can survive only provided there are gaps, as in "wattle-and-daub" walls. In South America, the Chagas disease, which leads to blindness, comes from insects that live in wattle-and-daub walls. Gaps can be avoided by constructing walls of rammed earth or mud bricks with totally filled mud mortar joints. Moreover, if the earth contains too many organic additives, as in the case of lightweight straw clay, with a density of less than 600 kg/m^3 , small insects such as wood lice can live in the straw and attack it. Common perceptions that loam surfaces are difficult to clean (especially in kitchens and bathrooms) can be dealt with by painting them with casein, lime-casein, linseed oil or other coatings, which makes them non-abrasive. As explained on p. 132, bathrooms with earth walls are more hygienic than those with glazed tiles, since earth absorbs high humidity quickly, thereby inhibiting fungus growth.

Note

For the conversion of metric values into imperial ones, see page 197.

2 The properties of earth as a building material

2.1 Soil grain size distribution of loams with high clay content (*above*), high silt content (*middle*), and high sand content (*below*)

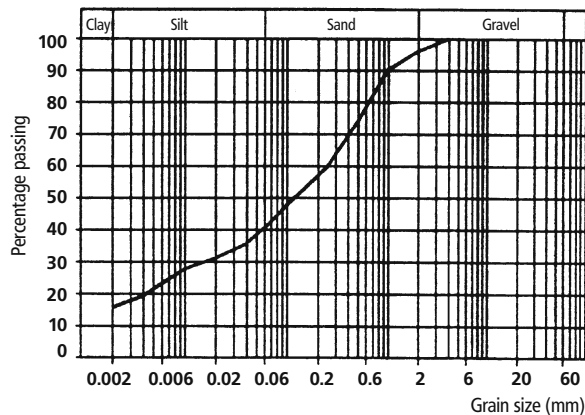
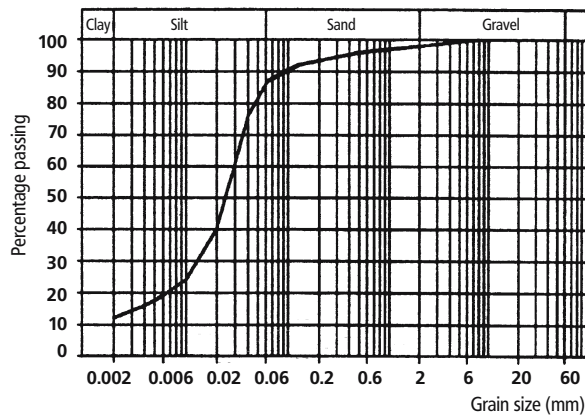
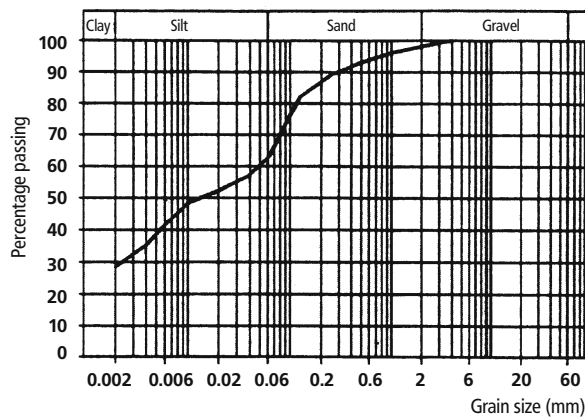

Composition

General

Loam is a product of erosion from rock in the earth's crust. This erosion occurs mainly through the mechanical grinding of rock via the movement of glaciers, water and wind, or through thermal expansion and contraction of rock, or through the expansion of freezing water in the crevices of the rock. Due to organic acids prevalent in plants, moreover, chemical reactions due to water and oxygen also lead to rock erosion. The composition and varying properties of loam depend on local conditions. Gravelly mountainous loams, for instance, are more suitable for rammed earth (provided they contain sufficient clay), while riverside loams are often siltier and are therefore less weather-resistant and weaker in compression. Loam is a mixture of clay, silt and sand, and sometimes contains larger aggregates like gravel and stones. Engineering science defines its particles according to diameter: particles with diameters smaller than 0.002 mm are termed clay, those between 0.002 and 0.06 mm are called silt, and those between 0.06 and 2 mm are called sand. Particles of larger diameter are termed gravels and stones. Like cement in concrete, clay acts as a binder for all larger particles in the loam. Silt, sand and aggregates constitute the fillers in the loam. Depending on which of the three components is dominant, we speak of a clayey, silty or sandy loam. In traditional soil

mechanics, if the clay content is less than 15% by weight, the soil is termed a lean clayey soil. If it is more than 30% by weight, it is termed a rich clayey soil. Components that form less than 5% of the total by weight are not mentioned when naming the soils. Thus, for instance, a rich silty, sandy, lean clayey soil contains more than 30% silt, 15% to 30% sand, and less than 15% clay with less than 5% gravel or rock. However, in earth construction engineering, this method of naming soils is less accurate because, for example, a loam with 14% clay which would be called lean clayey in soil mechanics, would be considered a rich clayey soil from the point of view of earth construction.

Clay

Clay is a product of the erosion of feldspar and other minerals. Feldspar contains aluminium oxide, a second metal oxide and silicon dioxide. One of the most common types of feldspar has the chemical formula $\text{Al}_2\text{O}_3 \cdot \text{K}_2\text{O} \cdot 6\text{SiO}_2$. If easily soluble potassium compounds are dissolved during erosion, then clay called Kaolinite is formed, which has the formula $\text{Al}_2\text{O}_3 \cdot 2\text{SiO}_2 \cdot 2\text{H}_2\text{O}$. Another common clay mineral is Montmorillonite, whose formula is $\text{Al}_2\text{O}_2 \cdot 4\text{SiO}_2$. There also exists a variety of less common clay minerals such as Illite. The structure of these minerals is shown in 2.2.

Clay minerals are also found mixed with other chemical compounds, particularly with hydrated iron oxide ($\text{Fe}_2\text{O}_3 \cdot \text{H}_2\text{O}$) and other iron compounds, giving the clay a characteristic yellow or red colour. Manganese compounds impart a brown colour; lime and magnesium compounds give white, while organic substances give a deep brown or black colour.

Clay minerals usually have a hexagonal lamellar crystalline structure. These lamellas consist of different layers that are usually formed around silicon or aluminium cores. In the case of silicon, they are surrounded by oxygenations; in the case of aluminium, by hydroxyl (ions) groups (-HO). The layers of silicon oxide have the strongest negative

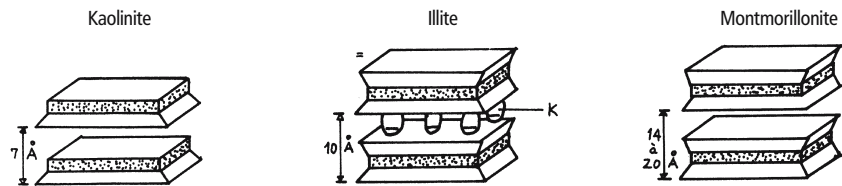

charge, which endows them with a high interlamellar binding force (see 2.3). Because each layer of aluminium hydroxide is connected to a layer of silicon oxide, the double-layered Kaolinite has a low ion-binding capacity, whereas with the three-layered mineral Montmorillonite, one aluminium hydroxide layer is always sandwiched between two layers of silicon oxide, thereby displaying a higher ion binding capacity. Most of the clay minerals have interchangeable cations. The binding force and compressive strength of loam is dependent on the type and quantity of cations.

Silt, sand and gravel

The properties of silt, sand and gravel are totally different from clay. They are simply aggregates lacking binding forces, and are formed either from eroding stones, in which case they have sharp corners, or by the movement of water, in which case they are rounded.

Grain size distribution

Loam is characterised by its components: clay, silt, sand and gravel. The proportion of the components is commonly represented on a graph of the type shown in 2.1. Here, the vertical axis represents weight by percentage of the total of each grain size, which in turn is plotted on the horizontal axis using a logarithmic scale. The curve is plotted cumulatively, with each grain size including all the fine components.

The upper graph characterises a rich clayey loam with 28% clay, 35% silt, 33% sand and 4% gravel. The middle graph shows rich silty loam with 76% silt, and the bottom graph a rich sandy loam containing 56% sand. Another method for graphically describing loam composed of particles no larger than 2 mm is shown in 2.4. Here the

2.2 Structure of the three most common clay minerals (according to Houben, Guillaud, 1984)
 2.3 Lamellar structure of clay minerals (according to Houben, Guillaud, 1984)
 2.4 Soil grain size distribution depicted on a triangular grid (after Voth, 1978)

Tetrahedron with silicon core

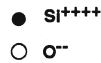
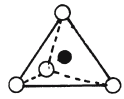

Octahedron with aluminium core

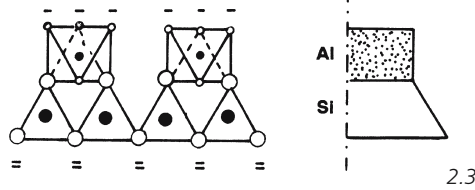
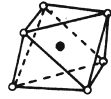

2.3

percentage of clay, silt and sand can be plotted on the three axes of a triangle and read accordingly. For example, loam marked S III in this graph is composed of 22% clay, 48% silt and 30% sand.

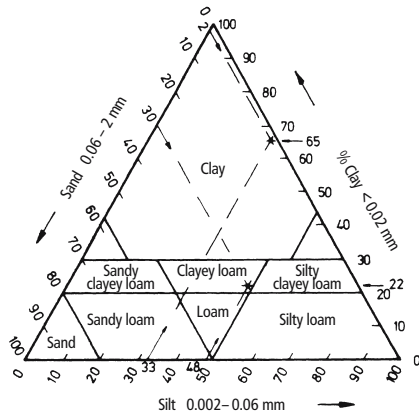

2.4

Organic constituents

Soil dug from depths of less than 40 cm usually contains plant matter and humus (the product of rotting plants), which consists mainly of colloidal particles and is acidic (pH-value less than 6). Earth as building material should be free of humus and plant matter. Under certain conditions, plant matter like straw can be added, provided it is dry and there is no danger of later deterioration (see p. 83).

Water

Water activates the binding forces of loam. Besides free water, there are three different types of water in loam: water of crystallisation (structural water), absorbed water, and water of capillarity (pore water). Water of crystallisation is chemically bound and is only distinguishable if the loam is heated to temperatures between 400°C and 900°C. Absorbed water is electrically bound to the clay minerals. Water of capillarity has entered the pores of the material by capillary action. Absorbed and capillary water are released when the mixture is heated to 105°C. If dry clay gets wet, it swells because water creeps in between the lamellar structure, surrounding the lamellas with a thin film of water. If this water evaporates, the interlamellar distance is reduced, and the lamellas arrange themselves in a parallel pattern due to the forces of electrical attraction. The clay thus acquires a “binding force” (see p. 32), if in a plastic state, and compressive and tensile strength after drying.

Porosity

The degree of porosity is defined by the total volume of pores within the loam. More important than the volume of the pores are the dimensions of the pores. The larger the porosity, the higher the vapour diffusion and the higher the frost resistance.

Specific surface

The specific surface of a soil is the sum of all particle surfaces. Coarse sand has a specific surface of about 23 cm²/g, silt about 450 cm²/g and clay, from 10 m²/g (Kaolinite) to 1000 m²/g (Montmorillonite). The larger the specific surface of clay, the higher the internal cohesive forces which are relevant for binding force as well as compressive and tensile strength.

Density

The density of soil is defined by the ratio of dry mass to volume (including pores). Freshly dug soil has a density of 1000 to 1500 kg/m³. If this earth is compressed, as in rammed earthworks or in soil blocks, its density varies from 1700 to 2200 kg/m³ (or more, if it contains considerable amounts of gravel or larger aggregates).

Compactability

Compactability is the ability of earth to be compacted by static pressure or dynamic compaction so that its volume is reduced. To attain maximum compaction, the earth must have a specific water content, the so-called “optimum water content,” which allows particles to be moved into a denser configuration without too much friction. This is measured by the Proctor test (see p. 44).

Tests used to analyse the composition of loam

To determine the suitability of a loam for a specific application, it is necessary to know its composition. The following section describes standardised laboratory tests and simple field tests that are used to analyse loam composition.

Combined sieving and sedimentation analysis

The proportion of coarse aggregates (sand, gravel and stones) is relatively easy to distinguish by sieving. However, the proportion of fine aggregates can only be ascertained by sedimentation. This test is specified in detail in the German standard DIN 18123.

Water content

The amount of water in a loam mixture can be easily determined by weighing the sample and then heating it in an oven to 105°C. If the weight stays constant, the mixture is dry, and the difference of the two weights gives the weight of all water not chemically bound. This water content is stated as a percentage of the weight of the dry mixture.

Simple field tests

The following tests are not very exact, but they can be performed on site relatively quickly, and are usually exact enough to estimate the composition of loam and ascertain if the mixture is acceptable for a specific application.

Smell test

Pure loam is odourless, however it acquires a musty smell if it contains deteriorating humus or organic matter.

Nibble test

A pinch of soil is lightly nibbled. Sandy soil produces a disagreeable sensation as opposed to silty soil, which gives a less objectionable sensation. Clayey soil, on the other hand, gives a sticky, smooth or floury sensation.

Wash test

A humid soil sample is rubbed between the hands. If the grains can be distinctly felt, it indicates sandy or gravelly soil. If the sample is sticky, but the hands can be rubbed clean when dry, this indicates silty soil. If the sample is sticky, so that water is needed to clean the hands, this indicates clayey soil.

Cutting test

A humid sample of the earth is formed into a ball and cut with a knife. If the cut surface is shiny, it means that the mixture has high clay content; if it is dull, it indicates high silt content.

Sedimentation test

The mixture is stirred with a lot of water in a glass jar. The largest particles settle at the bottom, the finest on top. This stratification allows the proportion of the constituents to be estimated. It is a wrong to assert that the height of each layer corresponds to the proportion of clay, silt, sand and gravel, as is claimed by many authors (e.g. CRATerre, 1979, p. 180; International Labour Office, 1987, p. 30; Houben, Guillaud, 1984, p. 49; Stulz, Mukerji, 1988, p. 20; United Nations Centre for Human Settlement, 1992, p. 7) (see 2.6).

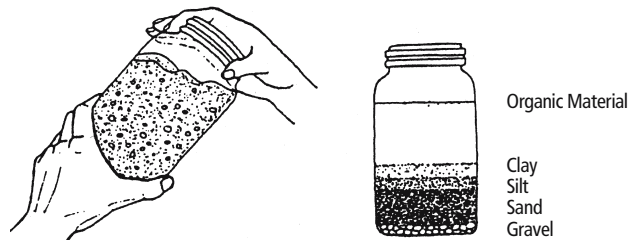

2.6

Several experiments at the Building Research Laboratory (BRL), University of Kassel, showed that the margin of error could be as large as 1750%, as seen in 2.5 and 2.8. In fact, one can only distinguish successive strata at sudden changes of grain-size distribution, and these may not coincide with the actual defined limits between clay and silt, and between silt and sand (see 2.7).

Ball dropping test

The mixture to be tested has to be as dry as possible, yet wet enough to be formed into a ball 4 cm in diameter. When this ball is dropped from a height of 1.5 m onto a flat surface, various results can occur, as shown in 2.9. If the ball flattens only slightly and shows few or no cracks, like the sample on the left, it has a high binding force due to high clay content. Usu-

Sample	Content	by vision		Real % (mass)
		% (vol.)	% (mass)	
K1	Clay	45	14	6
	Silt	18	26	38
	Sand	37	60	56
K2	Clay	36	17	2
	Silt	24	19	16
	Sand	40	64	82

2.5

2.5 Soil grain size distribution of two loams tested in the sedimentation test
2.6 Sedimentation test (CRATerre, 1979)
2.8 Sedimentation test

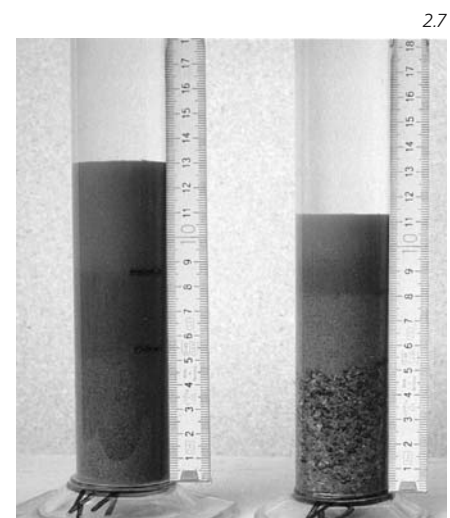

2.7



2.9

ally this mixture must be thinned by adding sand. If the test looks like the sample on the right, it has very low clay content. Its binding force is then usually insufficient, and it cannot be used as a building material. In the case of the third sample from the left, the mixture has a relatively poor binding force, but its composition usually enables it to be used for mud bricks (adobes) and rammed earth.

Consistency test

Moist earth is formed into a ball 2 to 3 cm in diameter. This ball is rolled into a thin thread 3 mm in diameter.

If the thread breaks or develops large cracks before it reaches 3 mm diameter, the mixture is slowly moistened until the thread breaks only when its diameter reaches 3 mm.

This mixture is then formed into a ball. If this is not possible, then the sand content is too high and the clay content too low. If the ball can be crushed between the thumb and forefinger only with a lot of force, the clay content is high and has to be thinned by adding sand. If the ball crumbles very easily, then the loam contains little clay.

Cohesion test (ribbon test)

The loam sample should be just moist enough to be rolled into a thread 3 mm in diameter without breaking. From this thread, a ribbon approximately 6 mm in thickness and 20 mm wide is formed and held in the palm. The ribbon is then slid along the palm to overhang as much as possible until it breaks (see 2.10).

If the free length before breakage is more than 20 cm, then it has a high binding force, implying a clay content that is too high for building purposes. If the ribbon breaks after only a few centimetres, the mixture has too little clay. This test is inaccurate, and at the BRL it was known to have margins of errors of greater than 200% if the loam was not well kneaded and the thickness and width of the ribbon varied.

For this reason, a new, more precise test was developed in which a 20-mm-wide and 6-mm-high profile was produced by pressing the loam with the fingers into the groove between two ledges. The surface is smoothed by rolling with a bottle (see 2.11). To prevent the loam profile from sticking, the base is lined with a thin strip of plastic or oilpaper. The length of the ribbon, when it breaks under its own weight, is measured by pushing it slowly over a rounded edge with a radius curvature of 1 cm (2.11, right). For each type of soil, five samples were taken and ribbon lengths measured at the point of rupture.

The longest rupture lengths from each set have been plotted in 2.12, against the bind-

2.8 Grain size distribution of test loams
2.9 Loam balls after the dropping test

2.8

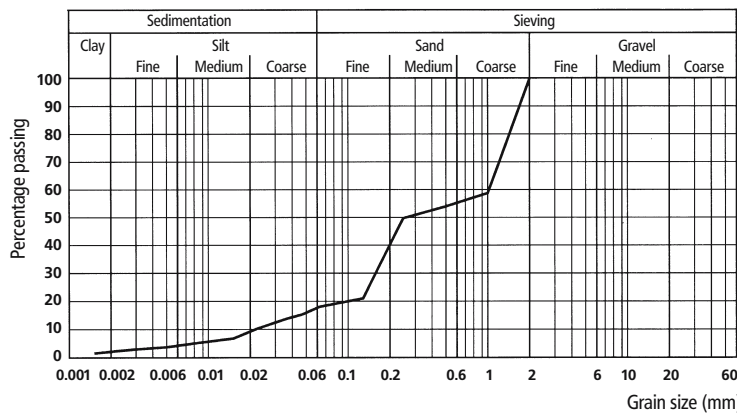
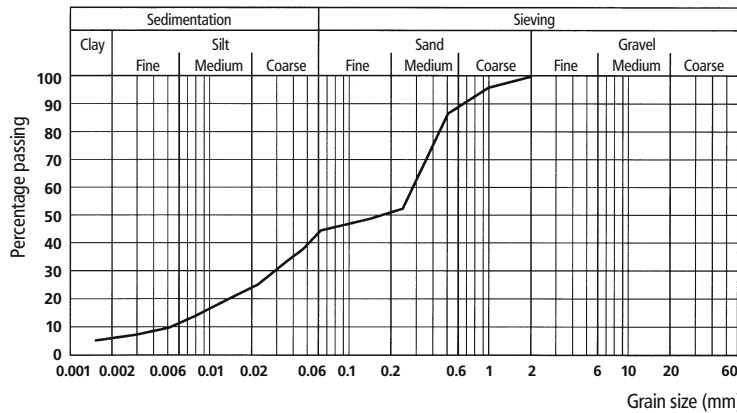

ing force according to the standard DIN 18952 test (see p. 32), with a slight change: here the maximum strength of five samples was also considered.

This is because it was found that the lower values were usually due to insufficient mixing, inaccurate plasticity or other preparation mistakes. In order to guarantee that different loam mixtures are comparable, the chosen consistency of the samples was defined by a diameter of 70 mm (instead of 50 mm) of the flat circular area, which forms if a test ball of 200 g weight is dropped from a height of 2 m. (With sandy loam mixtures with little clay content, a diameter of 50 mm is not attainable.)

Acid test

Loams that contain lime are normally white in appearance, exhibit a low binding force and are therefore inappropriate for earth construction. In order to define the lime content, one drop of a 20% solution of HCl is added using a glass or a timber rod. In the case of loam with lime content, CO₂ is produced according to the equation $\text{CaCO}_3 + 2\text{HCl} = \text{CaCl}_2 + \text{CO}_2 + \text{H}_2\text{O}$. This CO₂ production is observable because of the efflorescence that results; if there is no efflorescence, the lime content is less than 1%. If there is a weak, brief efflorescence, the lime content is between 1% and 2%; if the efflorescence is significant though brief, the lime content is between 3% and 4%; and if the efflorescence is strong and long lasting, the lime content is more than 5% (Voth, 1978, p. 59).

It should be noted that a dark lime-free loam with a high content of humus could also exhibit this phenomenon.

Effects of water

If loam becomes wet, it swells and changes from a solid to a plastic state.

Swelling and shrinking

The swelling of loam when in contact with water and its shrinkage through drying is

disadvantageous for its use as a building material. Swelling only occurs if loam comes into direct contact with so much water that it loses its solid state. The absorption of humidity from the air, however, does not lead to swelling.

The amount of swelling and shrinkage depends on the type and quantity of clay (with Montmorillonite clay this effect is much larger than with Kaolinite and Illite), and also on the grain distribution of silt and sand. Experiments were conducted at the BRL using 10 x 10 x 7 cm samples of different loam mixtures that were soaked with 80 cm³ of water and then dried in an oven at 50°C in order to study shrinkage cracks (2.13). Industrially fabricated unbaked blocks (2.13, top left), whose granularity curve is shown in 2.1 (upper left), display shrinkage cracks. A similar mixture with the same kind and amount of clay, but with "optimised" distribution of silt and sand, exhibited hardly any cracks after drying out (2.13, top right). The mud brick made of silty soil (2.13, bottom right) (granularity curve shown in 2.1, middle) shows several very fine cracks, whereas the mud brick of sandy soil (2.13, bottom left) (granularity curve shown in 2.1, bottom) shows no cracks at all. On p. 39 it is explained how shrinkage might be minimised by changing grain distribution.

Determining linear shrinkage

Before the shrinkage ratio of different loam samples can be compared, they must have comparable plasticity.

The German standard DIN 18952 describes the following steps required to obtain this standard stiffness:

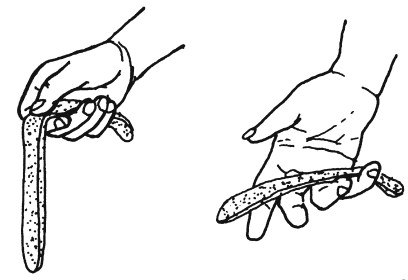

2.10

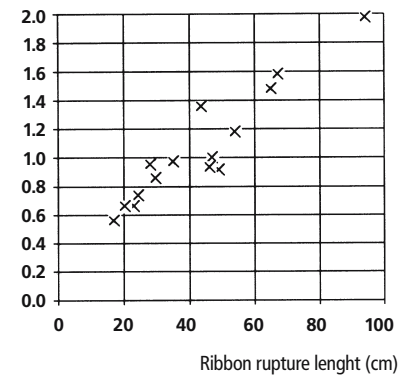

2.12

2.10 Ribbon test

2.11 Cohesion test developed at the BRL

2.12 Binding force of different loams of equal consistency in relation to their rupture lengths, tested according to the BRL cohesion test



2.11

2.13 Swelling and shrinkage test

2.14 Tools to distinguish the linear shrinkage

according to the German standard DIN 18952

2.15 Apparatus to obtain the liquid limit, according to Casagrande

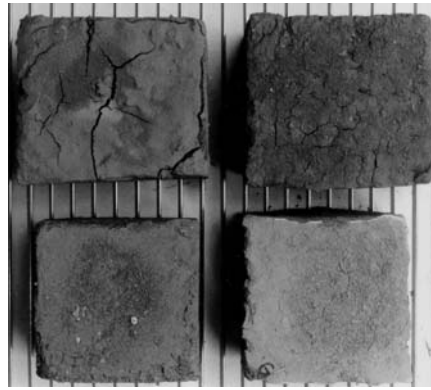

2.13

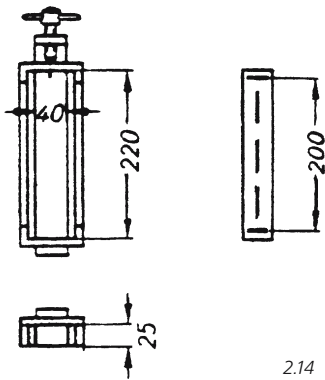

2.14

1. The dry loam mixture is crushed and sieved to eliminate all particles with diameters larger than 2 mm.
2. About 1200 cm³ of this material is slightly moistened and hammered on a flat surface to produce a continuous piece (like a thick pancake).
3. This is then cut into 2-cm-wide strips, placed edge-to-edge touching each other, then hammered again. This procedure is repeated until the lower part shows an even structure.

4. Loam with high clay content must then rest for twelve hours, and one with low clay content for about six hours, so that the water content is equally distributed throughout the sample.

5. From this mixture, 200 g are beaten, to compact into a sphere.
6. This ball is dropped from a height of 2 m onto a flat surface.
7. If the diameter of the flattened surface thus formed is 50 mm, standard stiffness is said to be reached. The difference between the largest and smallest diameters of this disc should not be more than 2 mm. Otherwise the whole process must be repeated until the exact diameter in the drop test is reached. If the disc diameter is larger than 50 mm, then the mixture has to be dried slightly and the whole process repeated until the exact diameter is attained.
8. If the diameter of the disc is less than 50 mm, then a few drops of water should be added.

With this standard stiffness, the shrinkage test is to be executed as follows:

1. The material is pressed and repeatedly rammed by a piece of timber about 2 x 2 cm in section into the form shown in 2.14, which rests on a flat surface.
2. Three samples have to be made and the form has to be taken off at once.
3. Template marks at a distance of 200 mm are made with a knife.
4. The three samples are dried for three days in a room. They are then heated to 60°C in an oven until no more shrinkage can be measured. The DIN mentions that they are to be dried on an oiled glass plate. The BRL suggests lining the plate with a thin layer of sand to make the drying process more even and avoiding friction.
5. The average shrinkage of the three samples in relation to the length of 200 mm gives the linear shrinkage ratio in percentages. If the shrinkage of one sample differs more than 2 mm from the other two, the sample has to be remade.

Plasticity

Loam has four states of consistency: liquid, plastic, semisolid and solid. The limits of these states were defined by the Swedish scientist Atterberg.

Liquid limit

The liquid limit (LL) defines water content at the boundary between liquid and plastic states. It is expressed as a percentage and is determined by following the steps explained below using the Casagrande instrument shown in 2.15:

1. The mixture must remain in water for an extended period (up to four days if the clay content is high) and then pressed through a sieve with 0.4 mm meshes.
2. 50 to 70 g of this mixture in a pasty consistency is placed in the bowl of the apparatus and its surface smoothed. The maximum thickness in the centre should be 1 cm.
3. A groove is then made using a special device, which is always held perpendicular to the surface of the bowl.
4. By turning the handle at a speed of two cycles per second, the bowl is lifted and



2.15

dropped until the groove is closed over a length of 10 mm.

5. The numbers of strokes are counted and a sample of 5 cm³ is taken from the centre in order to determine the water content.

When the groove closes at 25 strokes, the water content of the mixture is equal to the liquid limit.

It is very time-consuming to change the water content repeatedly until the groove closes at exactly 25 strokes. A special method described in the German standard DIN 18122 allows the test to run with four different water contents if the number of strokes is between 15 and 40. Illustration 2.16 shows how the liquid limit is obtained using these four tests. The four values are noted in a diagram whose horizontal co-ordinate shows the stroke numbers in a logarithmic scale, and the vertical co-ordinate shows the water content as a percentage. The liquid limit is obtained by drawing a line through the four values and reading the interpolated value at the co-ordinate of 25 strokes.

Plastic limit

The plastic limit (PL) is the water content, expressed as a percentage, at the boundary between plastic and semisolid states. It is determined by means of the following procedure: the same mixture that was used to define the liquid limit is rolled by hand onto a water-absorbent surface (cardboard, soft wood or similar material) into small threads of 3 mm diameter. Then the threads are moulded into a ball and rolled again. This procedure is repeated until the threads begin to crumble at a diameter of 3 mm. Ca. 5 g are removed from this mixture and immediately weighed, then dried to obtain the water content. This test is repeated three times. The average value of three samples that do not deviate by more than 2% is identical with the plastic limit. As the liquid and the plastic limits have been defined using a mixture containing only particles smaller than 0.4 mm, the test results must be corrected if larger grains

have been sieved out earlier. If that portion is less than 25% of the dry weight of the entire mixture, then the water content can be calculated using the following formula:

$$W_0 = \frac{L}{1-A}$$

where W_0 is the calculated water content, L the determined water content LL or PL, and A the weight of grains larger than 0.4 mm expressed as a percentage of the dry weight of the total mixture.

Plasticity index

The difference between the liquid limit and the plastic limit is called the plasticity index (PI). The table in 2.17 gives some typical values for LL, PL and PI.

Consistency number

The consistency number (C) can be calculated for any existing water content (W) of the plastic stage by using the following formula:

$$C = \frac{LL - W}{LL - PL} = \frac{LL - W}{PI}$$

The consistency number is 0 at the liquid limit and 1 at the plastic limit.

Standard stiffness

As the definition of the plastic limit in Atterberg is not very exact, Niemeier proposes "standard stiffness" as a basis for the comparison of mixtures of equal consistency. The method for obtaining this stiffness is described on p. 24.

Slump

The workability of mortar mixtures is defined by the slump. This can be specified by a method described in the German standards DIN 1060 (Part 3) or DIN 1048 (Part 1). Here, the mortar is poured through a standard funnel onto a plate that is lifted and dropped by a defined type and number of strokes. The diameter of the cake thus formed is measured in centimetres and is called the slump.

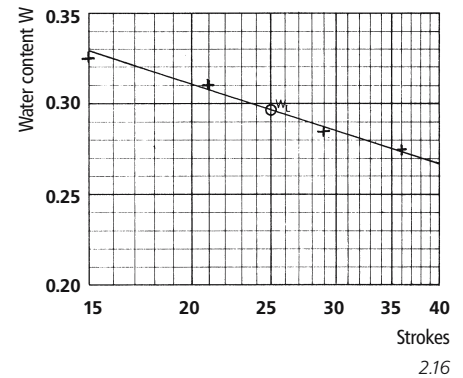

2.16 Deriving the liquid limit by the multi-point method according to the German standard DIN 18122

2.17 Plasticity index of loams (after Voth, 1978)

2.18 Test assembly to obtain the 'w'-values of loam samples (Boemans, 1990)

Type of loam	LL [%]	PL [%]	PI = LL - PL
sandy	10 – 23	5 – 23	< 5
silty	15 – 35	10 – 25	5 – 15
clayey	28 – 150	20 – 50	15 – 95
Bentonite	40	8	32

2.17

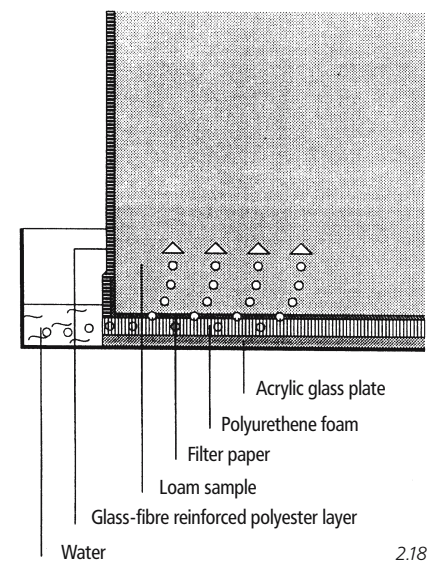

2.18

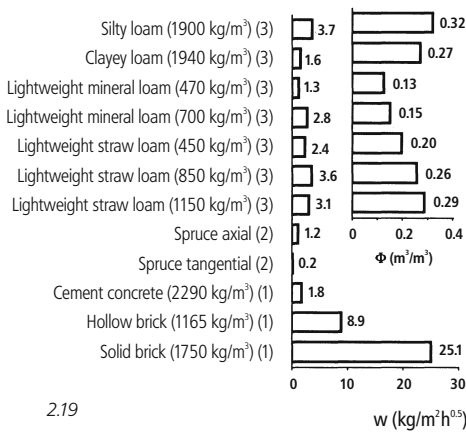

2.19 Water absorption coefficient 'w' of loams in comparison with common building materials
2.20 Water absorption curves of loams

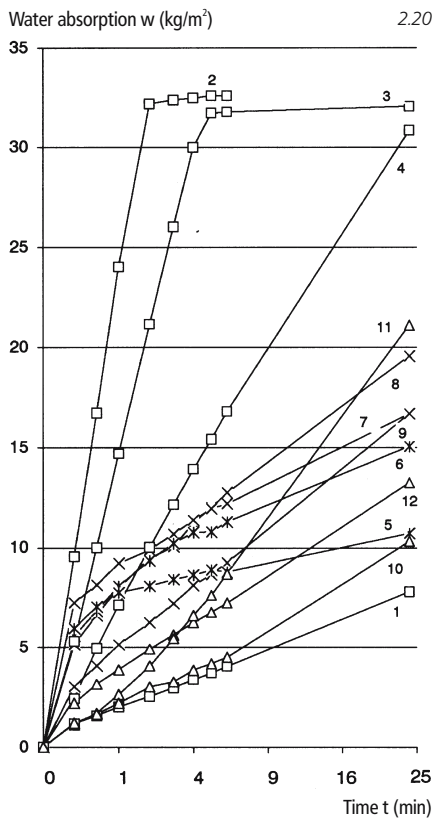

- 1 Clayey loam + sand
- 2 Clayey loam + 2% cement
- 3 Clayey loam + 4% cement
- 4 Clayey loam + 8% cement
- 5 Lightweight mineral loam 650
- 6 Lightweight mineral loam 800
- 7 Lightweight straw loam 450
- 8 Lightweight straw loam 850
- 9 Lightweight straw loam 1150
- 10 Clayey loam
- 11 Silty loam
- 12 Sandy loam

Shrinkage limit

The shrinkage limit (SL) is defined as the boundary between the semi-solid and solid states. It is the limit where shrinkage ceases to occur. With clayey soil, it can be identified optically when the dark colour of the humid mixture turns a lighter shade due to evaporation of water in the pores. Still, this is not an exact method of measurement.

Capillary action

Water movement

All materials with open porous structures like loam are able to store and transport water within their capillaries. The water, therefore, always travels from regions of higher humidity to regions of lower humidity. The capacity of water to respond to suction in this way is termed "capillarity" and the process of water transportation "capillary action."

The quantity of water (W) that can be absorbed over a given period of time is defined by the formula:

$$W = w \sqrt{t} \text{ [kg/m}^2\text{]}$$

where w is the water absorption coefficient measured in kg/m²h^{0.5} and t, the time in hours.

Determination of the water absorption coefficient

According to the German standard DIN 52617, the water absorption coefficient (w) is obtained in the following way: a sample cube of loam is placed on a plane surface and immersed in water to a depth of about 3 mm, and its weight increase measured periodically. The coefficient (w) is then calculated by the formula:

$$w = \frac{W}{\sqrt{t}} \text{ [kg/m}^2\text{h}^{0.5}\text{]}$$

where W is the increase in weight per unit surface area and t the time in hours elapsed. With this test, all four sides of the cube should be sealed so that no water enters from these surfaces, and only the bottom

surface is operative.

With loam samples, problems are caused by areas that swell and erode underwater over time. The BRL developed a special method to avoid this: to prevent the penetration of water from the sides as well as the swelling and deformation of the cube, samples are covered on all four sides by a glass-fibre reinforced polyester resin. To avoid the erosion of particles from the submerged surface, a filter paper is attached beneath and glued to the polyester resin sides. To prevent deformation of the weakened loam at the bottom during weighing, a 4-mm-thick sponge over an acrylic glass plate is placed underneath (see 2.18). A test with a baked brick sample comparing both methods showed that the BRL method reduced results by only 2%.

The coefficient w of different loams tested along with the w-values of common building materials is listed in 2.19. Interestingly, the silty soil samples gave higher w-values than those of clayey soil. Surprisingly, comparison with baked bricks shows that loam has w-values that are smaller by a factor of 10.

Water absorption in relation to time is also very interesting as shown in 2.20. Visible here is the amazing effect of a tremendous increase in absorption caused by adding small quantities of cement.

Capillary water capacity

The maximum amount of water that can be absorbed in comparison to the volume or mass of the sample is called "capillary water capacity" ([kg/m³] or [m³/m³]). This is an important value when considering the condensation phenomena in building components. Illustration 2.19 shows these values with the w-values.

Water penetration test after Karsten

In Karsten's water penetration test, a spherical glass container with a diameter of 30 mm and an attached measuring cylinder is fixed with silicon glue to the test sample so that the test surface in contact with the water is 3 cm² (Karsten, 1983, see 2.21). The

usual method using water is problematic, since the sample dissolves at the joint. Therefore, the BRL modified the method by closing the opening of the glass container with filter paper (see 2.22, right). Results using this method were comparable to those using the method given in the German standard DIN 52617 (see 2.23).

Stability in static water

Stability in static water can be defined after the German standard DIN 18952 (Part 2), as follows: a prismatic sample is immersed 5 cm deep in water and the time it takes for the submerged part to disintegrate is measured. According to this standard, samples that disintegrate in less than 45 minutes are unsuitable for earth construction. But this test is unnecessary for earth construction practices, since earth components would never be permanently immersed in water in any case. Significant instead is resistance to running water.

Resistance to running water

During construction, earth building elements are often exposed to rain and sensitive to erosion, especially if still wet. It is important, hence, to determine their resistance to running water. To compare the degrees of resistance of different loam mixtures, the BRL developed a test apparatus capable of testing up to six samples simultaneously (see 2.24). In this apparatus, water jets with diameters of 4 mm are sprayed onto the samples from a 45° angle and with a velocity of 3.24 m/sec, simulating the worst driving rain conditions in Europe.

Rain and frost erosion

Illustration 2.25 shows two samples: each is shown prior to testing (*left*), and after three years of weathering (*right*). The earth mixture of the sample on the right contained 40% clay; the one on the left was mixed with sand, reducing the clay content to 16%. Both mixtures were tested with a mortar consistency in single layers 5 cm in thickness. After drying, large shrinkage cracks appeared. The clayey mixture showed 11%

shrinkage, the sandy mixture only 3%. After three years of exposure to the weather, the clayey soil showed a special kind of scaling caused by frost. This was due to thin hairline cracks that appeared during drying, and through which rainwater was absorbed by capillary action. When this water freezes, its volume increases, causing the upper layers to burst. In areas where no hairline cracks were found, this effect did not occur. Furthermore, no rain erosion was observed in these areas. The sample on the left does not show this type of erosion after three years. Here we see that some loam is washed away by rain, so that the horizontal shrinkage crack is partially filled by these particles, but no frost erosion is observable. This is because there were no hairline cracks, and because the loam contained pores large enough to allow the freezing water to expand.

The test resulted in the following conclusions:

- sandy loam has little resistance against rain, but is frost-resistant when free of cracks;
- loam with high clay content tends to develop hairline cracks, and is therefore susceptible to frost. If there are no hairline cracks, it is almost rain-resistant.

The higher the porosity and the larger the pores, the higher loam's resistance to frost. Therefore, extruded common clay bricks produced in a factory are not frost-resistant and should not be used on outer exterior walls in climates with frost. By contrast, handmade adobes made from sandy loam are usually frost-resistant.

Drying period

The period during which wet loam reaches its equilibrium moisture content is called the "drying period." The decreasing water content and increasing shrinkage of a sandy mud mortar dried in a closed room at a temperature of 20°C and with a relative humidity of ambient air of 81% and 44% respectively is shown in 2.26. With 44% humidity, the drying took about 14 days, while with 81% humidity, about 30. Illustra-

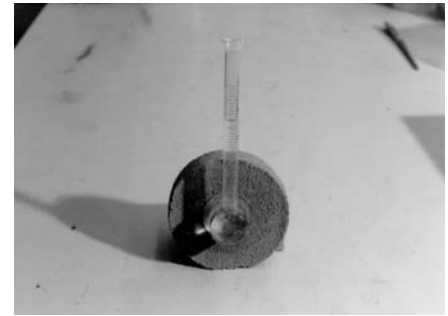

2.21

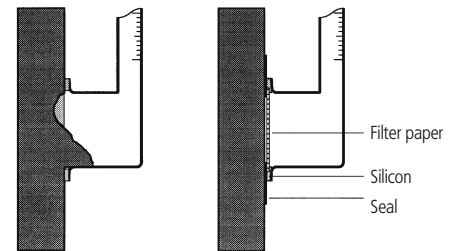

2.22

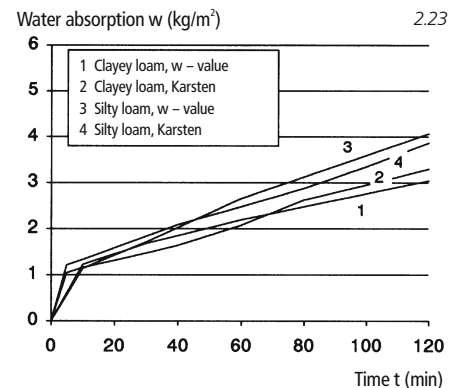

2.23

2.21 Modified water penetration test according to BRL

2.22 Modified water penetration test according to BRL

2.23 Water absorption according to Karsten and the German standard DIN 52617

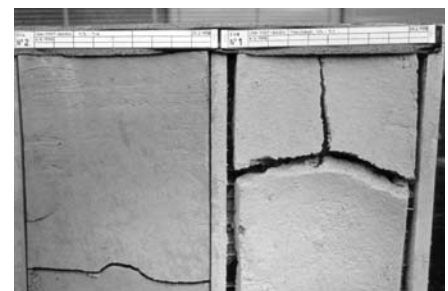

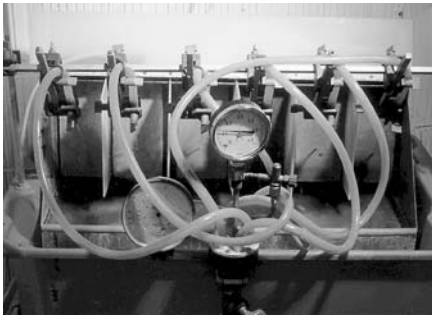

2.24

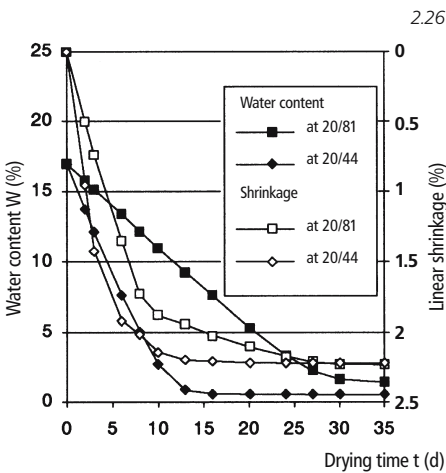

2.26

2.24 Water spraying test apparatus developed at the BRL

2.25 Loam samples before (left) and after (right) being exposed to weather for three years

2.26 Linear shrinkage and drying period of lean loam mortar (clay 4%, silt 25%, sand 71%) with a slump of 42 cm according to the German standard DIN 18555 (Part 2)

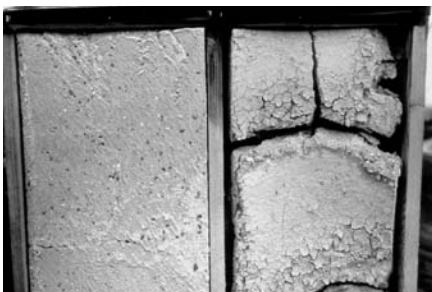

2.25

tion 2.27 shows the drying process of different loam samples compared to other building materials. In this test, conducted at the BRL, brick-size samples were immersed in 3 mm of water for 24 hours and then kept in a room with a temperature of 23°C and relative humidity of 50% in still air conditions. Interestingly, all loam samples dried out after 20 to 30 days, whereas baked clay bricks, sand-lime bricks and concrete had not dried out even after 100 days.

Effects of vapour

While loam in contact with water swells and weakens, under the influence of vapour it absorbs the humidity but remains solid and retains its rigidity without swelling. Loam, hence, can balance indoor air humidity, as described in detail on pp. 15–18.

Vapour diffusion

In moderate and cold climates where indoor temperatures are often higher than outside temperatures, there are vapour pressure differences between interior and exterior, causing vapour to move from inside to outside through the walls. Vapour passes through walls, and the resistance of the wall material against this action is defined by the “vapour diffusion resistance coefficient.” It is important to know the value of vapour resistance when the temperature difference between inside and outside is so high that the indoor air condenses after being cooled down in the wall.

The German standard DIN 52615 describes the precise test procedure used to determine these values. The product of m with the thickness of the building element s gives the specific vapour diffusion resistance s_d . Still air has an s_d -value of 1. Illustration 2.28 shows some of the μ -values determined by the BRL for different kinds of loam. It is interesting to note that silty loam has an μ -value about 20% lower than that of clayey and sandy loams, and that lightweight loam with expanded clay weighing 750 kg/m³ has a value 2.5 times higher than that of

loam mixed with straw and having the same overall density.

Chapter 12 (p. 98) describes how painting reduces the permeation of vapour through walls.

Equilibrium moisture content

Every porous material, even when dry, has a characteristic humidity, called its “equilibrium moisture content,” which depends on the temperature and humidity of the ambient air. The higher temperature and humidity levels are, the more water is absorbed by the material. If temperature and air humidity are reduced, the material will desorb water. The absorption curves of different loam mixtures are shown in 2.29. The values vary from 0.4% for sandy loam at 20% air humidity to 6% for clayey loam under 97% air humidity. It is interesting to note that rye straw under 80% humidity displays an equilibrium moisture content of 18%. In contrast, expanded clay, which is also used to achieve lightweight loam, reaches its equilibrium moisture content at only 0.3%. In 2.30, four values of loam mixtures are shown in comparison to the values of other common building materials.

Here, one can see that the higher the clay content of loam, the greater its equilibrium moisture content. Additionally, it should be mentioned that Bentonite, which contains 70% Montmorillonite, has an equilibrium moisture content of 13% under 50% humidity, whereas the equilibrium moisture content of Kaolinite under the same conditions is only 0.7%.

The graph shows that silty earth blocks or adobes (no. 4 on the graph) reach a moisture content five times higher than a sandy loam plaster (no. 9 on the graph) at a relative humidity of 58%.

It should be noted that for the humidity balancing effect of building materials, the speed of absorption and desorption processes is more important than the equilibrium moisture content, as explained on p. 14.

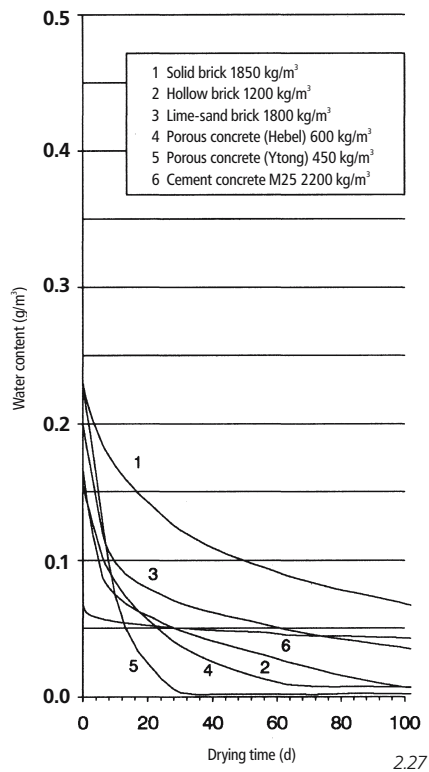
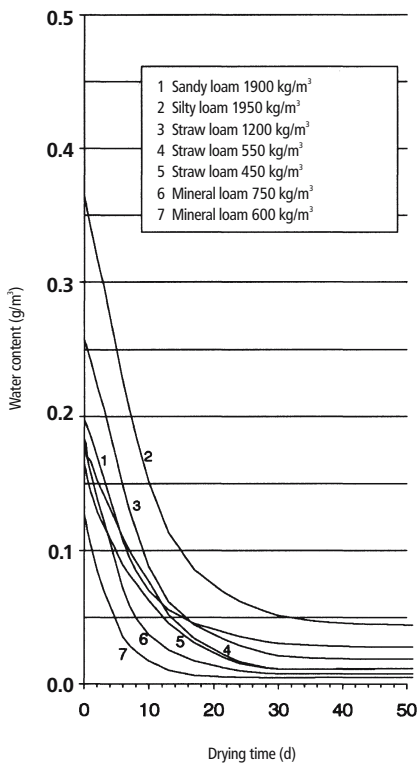

2.27 Drying period of loams and other building materials

2.28 The vapour diffusion coefficient μ of different loams and plasters according to the German standard DIN 52615, wet method

2.29 Absorption curves of solid (left) and light-weight (right) loams

2.30 Equilibrium moisture content of different loams and other building materials

2.31 U-values of loam

Condensation

In moderate and cold climatic zones, the water vapour contained in indoor air diffuses through the walls to the exterior. If the air is cooled down in the walls and reaches its dew point, condensation occurs. This dampness reduces thermal insulation capacity and may lead to fungus growth. In such cases, it is important that this humidity be transported quickly by capillary action to the surface of the walls, where it can evaporate. Therefore, materials like loam with a high capillarity are advantageous.

In order to reduce the danger of condensation in walls, vapour transmission resistance should be higher inside than outside. On the other hand, resistance to heat transfer should be higher outside than inside. Though the above principles normally suffice to inhibit the formation of condensation in walls, it is also possible to create a vapour barrier on the inside by utilising paints or sheets.

It should be mentioned, however, that vapour barriers have two important disadvantages.

- Vapour barriers are never fully sealed in practice, especially at joints, as in walls with

doors, windows and in ceilings. Harmful condensation can occur in these joints.

- With monolithic wall sections, water penetrates in the rainy season from the outside into the wall, and then cannot evaporate

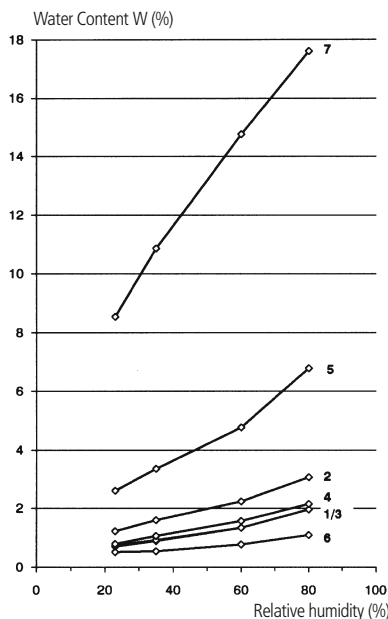

- | | |
|------------------------|-------------------------|
| 1 Clayey loam | 5 Loam brick |
| 2 Silty loam | 6 Kaolinite, pulverized |
| 3 Sandy loam | 7 Bentonite, pulverized |
| 4 Granular clayey loam | |

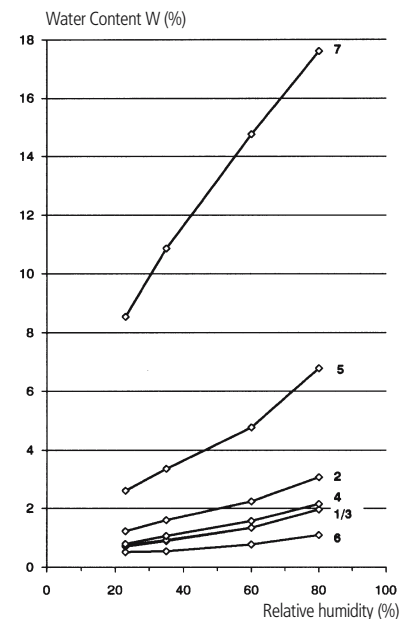

- | | |
|-------------------------------|-------------------------------|
| 1 Straw loam 450 | 6 Loam with expanded clay 700 |
| 2 Straw loam 850 | 7 Expanded clay particles |
| 3 Straw loam 1200 | 8 Expanded glass particles |
| 4 Loam with expanded clay 450 | 9 Rye straw |
| 5 Loam with expanded clay 550 | |

2.29

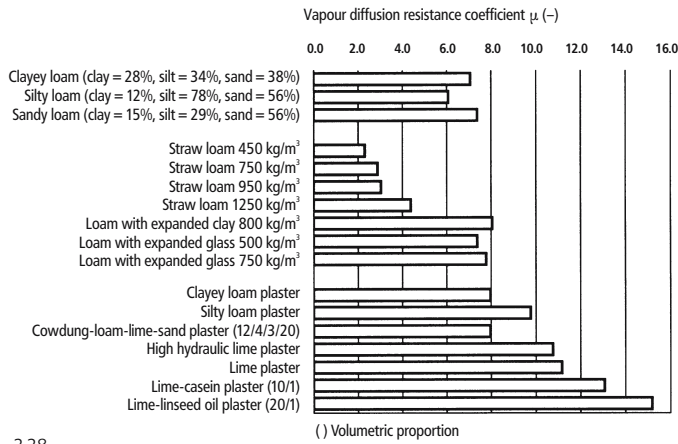

2.28

on the inside due to the vapour barrier. In this case, the wall remains damp for a longer period than it would without a vapour barrier.

Influence of heat

The common perception that earth is a very good material for thermal insulation is unproven. A solid wall of rammed earth without straw or other light aggregates has nearly the same insulating effect as a solid wall of baked bricks. The volume of air entrained in the pores of a material and its humidity are relevant for the thermal insulation effect. The lighter the material, the higher its thermal insulation, and the greater its humidity level, the lower its insulating effect.

The heat flowing through a building element is defined by the overall heat transfer coefficient U.

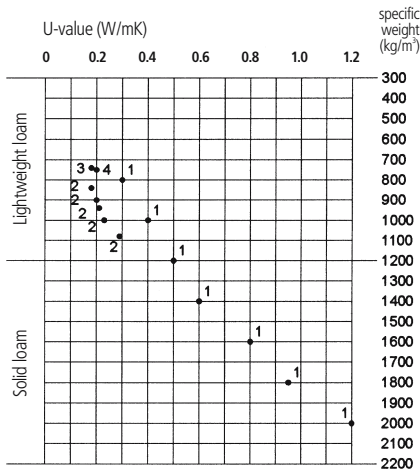

2.31

2.30

- 1 Spruce, planed
- 2 Limba, planed
- 3 Earth block, clayey
- 4 Earth block, silty
- 5 Cement plaster
- 6 Lime-cement plaster
- 7 Lime-casein plaster
- 8 Silty loam plaster
- 9 Clayey loam plaster
- 10 Solid brick
- 11 Clinker brick
- 12 Porous brick
- 13 Lime-sand brick
- 14 Porous concrete

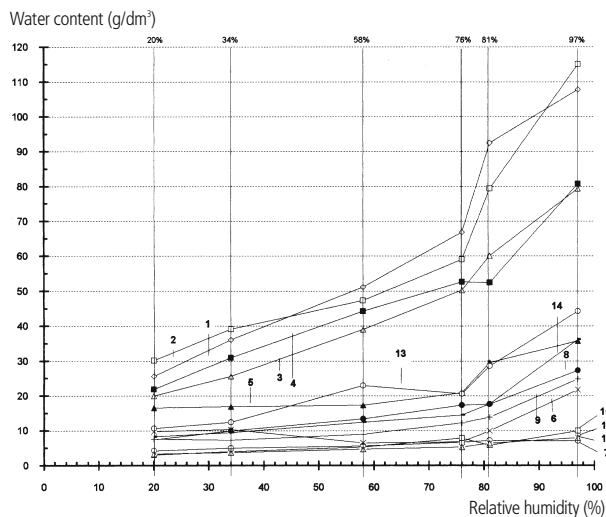

Thermal conductivity

The heat transfer of a material is characterised by its thermal conductivity k [W/mK]. This indicates the quantity of heat, measured in watts/m², that penetrates a 1-m-thick wall at a temperature difference of 1°C.

In 2.31, the different k -values according to DIN 4108-4 (1998), indicated by a 1, are shown. 2 are measurements of Vanros, 3 and 4 of the BRL.

At the BRL, a lightweight straw loam with a density of 750 kg/m³ gave a k -value of 0.20 W/mK, whereas a lightweight expanded clay loam with a density of 740 kg/m³ gave a value of 0.18 W/mK.

Specific heat

The amount of heat needed to warm 1 kg of a material by 1°C is called its "specific heat," represented by c . Loam has a specific heat of 1.0 kJ/kgK which is equal to 0.24 kcal/kg°C.

Thermal capacity

The thermal capacity (heat storage capacity) S of a material is defined as the product of specific heat c and the density r :

$$S = c \cdot \rho \text{ [kJ/m}^3\text{K]}$$

The thermal heat capacity defines the amount of heat needed to warm 1 m³ of material by 1°C. The heat storage capacity Q_s for a unit area of wall is S multiplied by the thickness s of the element:

$$Q_s = c \cdot \rho \cdot c \text{ [kJ/m}^2\text{K]}$$

Heat intake and release

The speed at which a material absorbs or releases heat is defined by the thermal diffusivity b which is dependent on the specific heat c , density r and the conductivity k :

$$b = \sqrt{c \cdot \rho \cdot k} \text{ [kJ/Km}^2\text{h}^{0.5}]$$

The larger the b -value, the quicker the penetration of heat.

Decrement factor and time lag

“Decrement factor” and “time lag” refer to the way the exterior wall of a building reacts to damp and to the period of delay before outside temperatures reach the interior. A wall with a high thermal storage capacity creates a large time lag and heat decrement, while a wall with high thermal insulation reduces only temperature amplitude.

In climates with hot days and cold nights, where average temperatures lie within the comfort zone (usually 18° to 27°C), thermal capacity is very important in creating comfortable indoor climates. In 2.32, the effect of material and building shape on interior climate is shown by readings taken from two test buildings of equal volume constructed in Cairo, Egypt, in 1964. One was built of 50-cm-thick earth walls and mud brick vaults, and the other of 10-cm-thick pre-cast concrete elements with a flat roof. While the diurnal variation of the outside temperature was 13°C, the temperature inside the earth house varied only by 4°C; in the concrete house, the variation was 16°C. Thus, the amplitude was four times greater in the concrete house than in the earth house. In the concrete house, temperatures at 4 pm were 5°C higher than outside, whereas inside the earth house, they were 5°C lower than outside temperatures at the same time (Fathy, 1986).

Thermal expansion

The expansion of a material caused by raising its temperature is relevant for mud plasters on stone, cement or brick walls, and for lime or other plasters on earth walls. The coefficients of linear expansion measured by the BRL for heavy loam range from 0.0043 to 0.0052 mm/m·K; for mud brick masonry up to 0.0062 mm/m·K; and for sandy mud mortar up to 0.007 mm/m·K. Soft lime mortar has a value of 0.005 mm/m·K, and strong cement mortar 0.010 mm/m·K, the same as concrete (Knöfel, 1979 and Künzel, 1990).

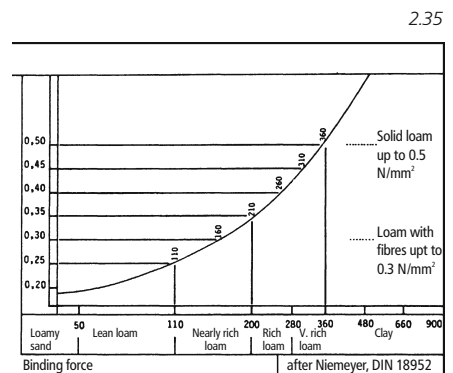
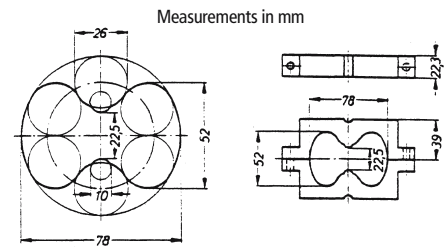
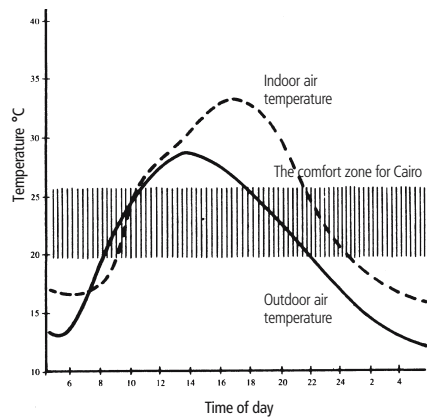
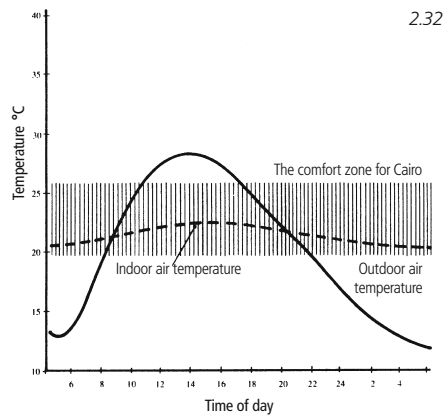

Fire resistance

In the German standard DIN 4102 (Part 1, 1977) loam, even with some straw content, is “not combustible” if the density is not less than 1700 kg/m³.

Strength

Binding force

The tensile resistance of loam in a plastic state is termed its “binding force.” The binding force of loam depends not only on clay content, but also on the type of clay minerals present. As it is also dependent on the water content, the binding force of different loams can only be compared if either water content or plasticity are equal. According to the German standard DIN 18952 (Part 2), the loam must have the defined “standard stiffness.” How this is obtained is described in this chapter on p. 24. The samples to be tested have a special figure-8-shape made from a mixture of standard stiffness. The samples are filled

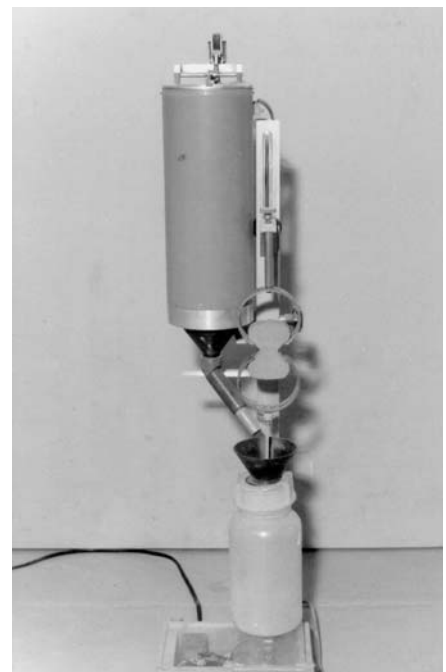

2.34

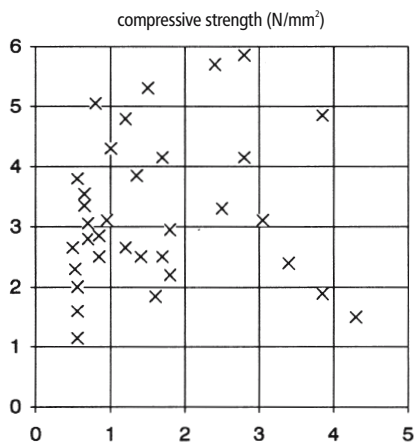

2.36

2.32 Comparison of indoor and outdoor air temperature of a building with adobe vaults (above) with one using prefabricated concrete slabs (below) (Fathy, 1986)

2.33 Mould for preparing test samples for the binding strength test according to the German standard DIN 18952

2.34 Test apparatus to measure the binding force, developed at the BRL

2.35 Relation of the binding force to the permissible compressive stress in loam elements, according to Niemeyer

2.37

Specific weight [kg/m³]	Compressive strength [kg/cm²]	Allowable compressive force [kg/cm²]					
		wall	column height/thickness				
			11	12	13	14	15
1600	20	3	3	2	1		
1900	30	4	4	3	2	1	
2200	40	5	5	4	3	2	1

2.38

	Strength [N/mm²]		
	Compression	Bending tension	Tension
Green Brick A	3.5	1.1	0.4
Green Brick B	4.4	1.3	0.5
Green Brick C	6.1	1.6	0.6
Mortar D	2.02	0.69	0.21
Mortar E	2.63	0.85	0.35

2.36 Relation of binding force to compressive strength of various test loams according to Gotthardt, 1949, and tests of the BRL

2.37 Permissible compressive stresses in loams according to the German standard DIN 18954

2.38 Strength of green bricks and earth mortar

and rammed with a tool in a formwork in three layers (see 2.33). At least three samples have to be made from each mixture in this way for immediate loading in the special testing apparatus seen in 2.34. Here, sand is poured into a container hanging on the lower part of the sample at a rate of not more than 750 g per minute. The pouring is stopped when the sample breaks. The weight under which the sample breaks, divided by the section of the sample, which is 5 cm², gives the binding force. Then an average is derived from the results of three samples that do not differ by more than 10%. Typically, values vary from 25 to 500 g/cm². Though in DIN 18952, soils with binding forces below 50 g/cm² were not recognised for building purposes, tests on a variety of historic rammed earth walls in Germany showed that some of these, in fact, had much lower binding forces, and one sample was even as low as 25 g/cm².

Compressive strength

The compressive strength of dry building elements made of earth, such as earth blocks and rammed earth walls, differ in general from 5 to 50 kg/cm². This depends not only on the quantity and type of clay involved, but also on the grain size distribution of silt, sand and larger aggregates, as well as on the method of preparation and compaction.

The methods for treatment and additives for increasing the compressive strength of loam are discussed on p. 41. Niemeyer's assertion (1946) that the compressive strength is proportionate to the binding force, and therefore that loams with equal binding forces should fall within the same range of permissible stresses for use in buildings (see 2.35),

is disproved by Gotthardt (1949) and by the BRL. By Niemeyer's extrapolations, a loam with a binding force of 60 g/cm² would have a permissible compression of 2 kg/cm², and a loam with a binding force of 360 g/cm² would have a permissible compression of 5 kg/cm². Experiments at the BRL resulted in samples of a silty loam with a binding force of 80 g/cm² but a compressive strength of 66 kg/cm², while they also found samples of silty clay with a binding force of 390 g/cm² which only displayed a compressive strength of 25 kg/cm². Some of these results are shown in 2.36.

The permissible compressive strength of earth building elements according to DIN 18954 is between 3 and 5 kg/cm² (see 2.37). By this reasoning, the overall factor of safety in earth components is about 7. This implies that actual compressive strength is seven times higher than the stress allowed in the building illustrated in 1.11, built in 1828 and still in use, we have five-storey-high solid rammed earth walls, and the maximum compression at the bottom is 75 kg/cm² (Niemeyer, 1946), which would not have been permissible as per DIN 18954.

In Yemen, there are examples of solid earth houses as much as twice the height of the one mentioned above. Obviously, it is possible to build a ten-storey-high earth house, but DIN 18954 permits only two storeys. According to Indian standards for stabilised soil blocks, the wet compressive strength of the block has to be tested as well. Here, the block has to be immersed to a depth of 3 mm in water for 24 hours.

Tensile strength

The tensile strength or binding force of a plastic loam was described on p. 32. For earth construction, the direct tensile strength of the dry material is of no relevance, because earth structures must not be under tension.

Table 2.38 shows that dry tensile strength is about 10% of compressive strength with blocks, and 11 to 13% with earth mortars.

Bending tensile strength

The bending tensile strength of dry loam is of little importance for earth construction. Still, it has a certain significance when judging the quality of mud mortar and the edge rigidity of mud bricks.

Bending tensile strength depends mainly on the clay content and the type of the clay minerals involved. Montmorillonite clay has a much higher bending tensile strength than Kaolinite. The lowest value investigated by Hofmann, Schembra, et. al. (1967) with Kaolinite reached 1.7 kg/cm^2 , the highest with Montmorillonite clay 223 kg/cm^2 . Clays without Montmorillonite tested by Hofmann, Schembra et. al. (1967) showed tensile bending strengths between 17 and 918 N/cm^2 .

Bond strength

Adhesive or bond strength is important only with mud mortars. It depends on the roughness of the base and the bending tensile strength of the mortar. While the German standard DIN 18555 (Part 6) gives a complex standard testing method to obtain this, a very simple test to check the bond strength is shown in 2.39: two baked bricks are joined by a 2-cm-thick mortar, the upper skewed at 90° to the lower. After the mortar is dry, the upper brick is laid on brick supports at both ends, while the lower is loaded with a sand-filled container. When the mortar breaks, the weight of the lower brick and the sand-filled container divided by the mortar area gives the adhesive strength. However, this is relevant only if failure occurs at the joint. If it occurs within the mortar, then this represents the direct tensile strength of the mortar, which is less than that of the bond.

Resistance to abrasion

Loam surfaces like mud mortar and mud floors are sensitive to abrasion. One simple test for abrasion is to use a metal brush, loaded by a weight of about 5 kg, and move it over the loam sample from side to side. The material that comes off after a certain number of cycles is weighed and



2.39

compared with that of other samples. A plate covered with sand paper can also be used in place of a metal brush. At the BRL, a special test for loam surfaces was developed: a strong plastic brush of 7 cm diameter is rotated on the surface under a pressure of 2 kg. After 20 cycles, the amount of abrasion is weighed. Illustration 2.40 shows the apparatus and 2.41 the results with different earth plasters available on the German market.

Modulus of elasticity

The dynamic modulus of elasticity of loam usually lies between 600 and 850 kg/mm^2 .

Impact strength of corners

Due to mechanical impacts, corners often break during the handling of mud bricks. In practise, therefore, this kind of strength is more important than either compressive or bending strength. At the BRL, a special test was developed to measure this kind of strength against shocks (see 2.42): a weight is dropped onto the surface at a 60° angle, 10 mm distant from the corner. Its bottom is formed by a semi-spherical steel ball 30 mm in diameter.



2.40

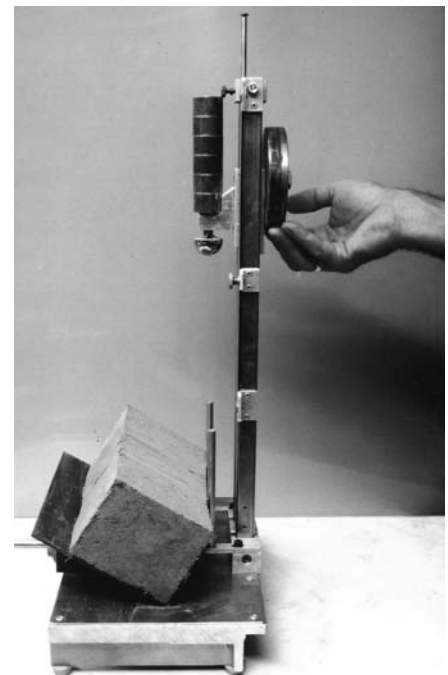

2.42

- 2.39 Field test to derive the bond strength of mud mortar
- 2.40 Apparatus to test the resistance against abrasion, BRL
- 2.41 Amount of abrasion of different earth plasters
- 2.42 Apparatus to measure the strength of corners against dynamic impacts
- 2.43 Shelter effect of different building materials against high-frequency electromagnetic radiation

2.43

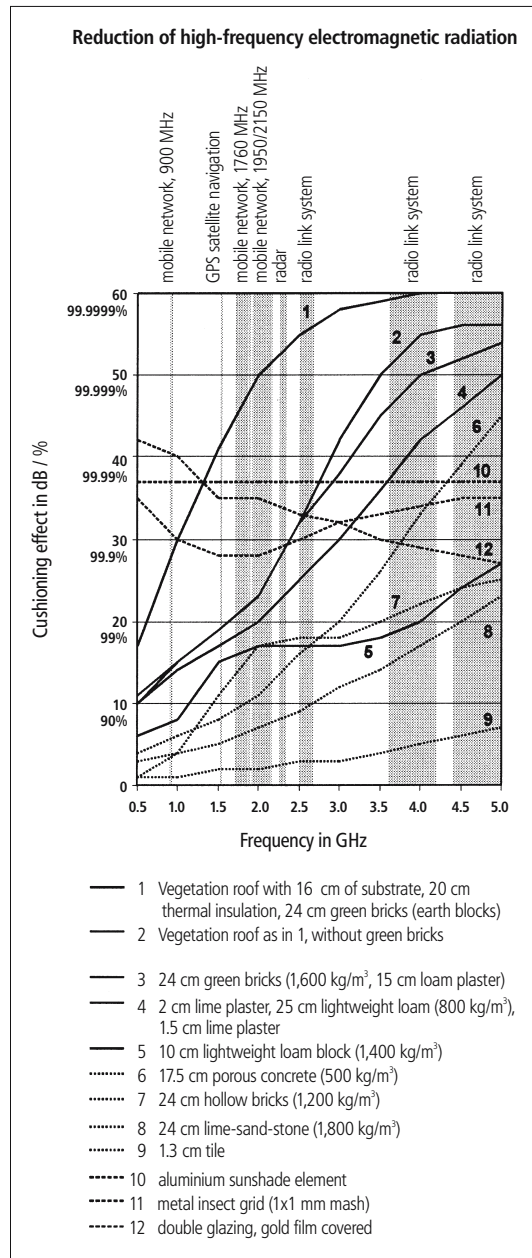

Radioactivity

Measurements of the radiation of beta and gamma rays show that loam has values no higher on average than concrete or baked bricks. On the contrary, some bricks tested by this author exhibited much more radiation, probably caused by additives like fly ash or blast furnace slag. Much more important than the beta and gamma rays are the alpha rays emitted by the radioactive gas radon and its short-lived decay products. The "soft" rays cannot penetrate the human body as they are absorbed by the skin, but can be inhaled by breathing and, therefore, may cause lung cancer. The following table shows the exhalation rate of radon given by the OECD (1979) for Germany, measured in m becquerel/kg h.

Natural gypsum	25.2
Cement	576
Sand	54.0
Baked clay bricks	5.0
Lime-sand bricks	13.3
Porous concrete	18.0

This shows that a clay brick from a clayey soil discharges very little radon.

Shelter against high-frequency electromagnetic radiation

Illustration 2.43 shows the differing degrees of effectiveness of solid building materials in screening (reducing) high-frequency electromagnetic radiation, as measured at the University of the Federal Armed Forces at Munich.

In the area of 2 gigahertz frequencies at which most cellular (mobile) phones are working, a 24-cm-thick mud brick wall creates a reduction of 24 dB (decibels), whereas an equal thick wall of a lime-sand stone only absorbs 7 dB.

2.41

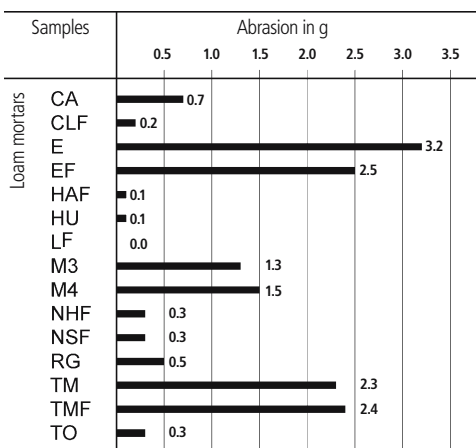

pH-value

Clayey soil is usually basic, with pH-values between 7 and 8.5. Nowadays, due to acid rain, earth dug from industrial areas may be slightly acidic just below the topsoil. The basic state usually prevents fungus growth (the favourable pH-value for fungus usually lies between 6.5 and 4.5).

3 Preparing of loam



3.1

It is not always easy to produce building material out of a clayey soil, and experience is required. The right preparation depends on the type of earth, its consistency and its expected application.

Moist crumbled earth with less clay and more sand content can be used immediately to build a rammed earth wall even as it is dug out. Clods of earth with high clay content cannot be used as a building material; they must either be crushed or dissolved in water and thinned with sand. This chapter describes the different possibilities of preparing earth for specific applications.

Soaking, crushing and mixing

There are several methods available for making workable building material out of clods of earth. One of the easiest methods for reducing the size of clods and making their consistency workable without mechanical labour is to place the earth clods in water so that they can become plastic on their own. The loam-clods are placed in large flat containers in a layer 15 to 25 cm high and then covered with water. After two to four days, a soft mass is obtained which can be easily moulded and mixed by hand, feet or machines, together with aggregates such as sand and gravel.

In cold climates where there is sufficient frost, a traditional method is to stack the moistened earth 20 to 40 cm high and allow it to freeze over winter so that disintegration occurs due to the expansion of freezing water.

The easiest way to prepare the right loam mixture is by mixing the wet loam with a hoe or moulding it with the feet. Animal power can also be used. Straw, chaff, coarse sand and other additives can be mixed during the same operation.

At the Building Research Laboratory (BRL) at the University of Kassel in Germany, an effective mud wheel was built (3.1) in which two pairs of old truck tyres were filled with concrete and used to prepare the mixture. The tyres were mounted on a horizontal beam fixed to a vertical central post and powered by a tractor or by animal or manu-

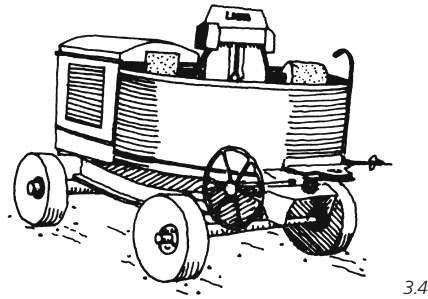
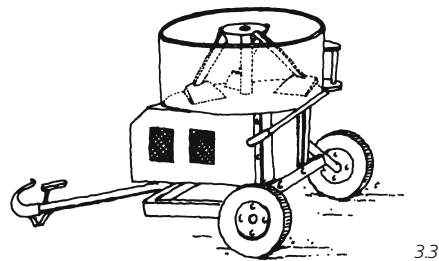
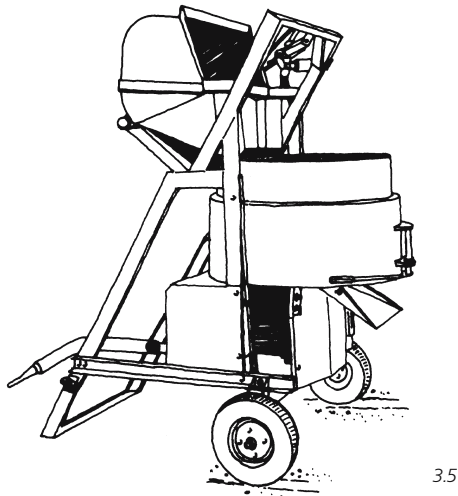

- 3.1 Mixing unit used at the BRL, Kassel
- 3.2 Garden cultivator
- 3.3 Forced mixer
- 3.4 Mortar mixer with rollers
- 3.5 Forced mixer with loading device
- 3.6 Forced loam mixer (Heuser)
- 3.7 Electrical hand mixer
- 3.8 Electrical crusher

al power. With an adequate addition of water, one cubic metre of usable loam could be produced in about 15 minutes (with the help of two or three people, mainly to scoop the overflowing mud back into the track). If a tractor is available, it is easy and more effective to simply spread earth on a field and drive back and forth over it.

For small quantities, a small garden cultivator is very useful (3.2). In modern earth construction technology, forced mixers are used. Here, the mixing is done with the help of revolving arms that are fixed either to a vertical (3.3) or horizontal axis (3.6). It is convenient to have a mechanical device for filling this mixer, as seen in 3.5.

Old mortar mixing machines can also be used, like ones that have rotating rollers (3.4). The machine in 3.6 was specially developed for preparing loam from any kind of soil (by the German firm Heuser). A quicker method of preparing a loam from dry clods of clayey soil is to crush them in





3.9

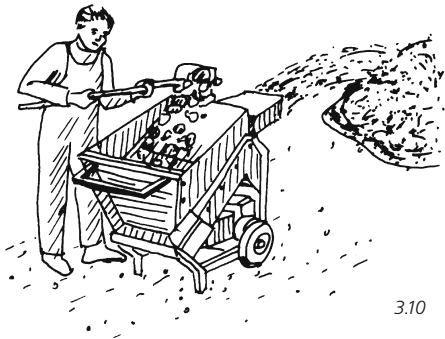

3.10

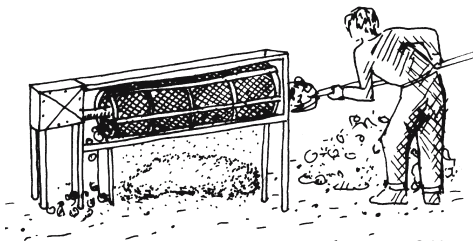

3.11

- 3.9 Crusher (Ceratec)
- 3.10 Crusher (Royer)
- 3.11 Sieving device
- 3.12 Rakes for preparing loam slurries

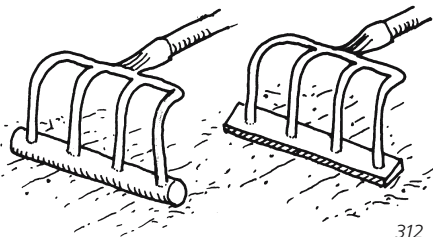

3.12

a machine (3.8). This has steel angles fixed onto a horizontal plate, which rotates at a rate of 1440 rotations per minute. It requires an electric engine of 4 kW. The machine does not work if the lumps are wet. Another example can be seen in 3.9, manufactured by Ceratec, Belgium, which is able to crush up to 20 m³ of clods in eight hours with a 3-horse-power engine. In this machine, the clods are crushed by two counter-rotating cylinders. The machine shown in 3.10, manufactured by the firm Royer in France, can crush up to 30 m³ of earth clods in eight hours.

It is always important to get the ready-mixed material out of the container fairly soon. There are different possibilities for doing so: the machine shown in 3.5 has an opening at the bottom through which the mixture can be pushed automatically into a wheelbarrow, and the container of the apparatus can be tilted so that it falls into the flat wheelbarrow below.

Common concrete mixers where only the drum rotates are unsuitable for preparing loam mixtures, because in them, the clods of earth agglomerate instead of breaking down.

An electric hand mixer of the kind shown in 3.7 is very time-consuming and is recommended only if small quantities of mud mortar or plaster are to be prepared.

Sieving

For specific earth construction techniques, it might be necessary to sieve out larger particles. The simplest method that can be used

is to throw the dry material over a sieve. More effective is an apparatus with a cylindrical sieve that is inclined and turned by hand or engine (3.11).

Mechanical slurring

In order to enrich a sandy soil with clay or prepare a lightweight loam, slurry is usually required. This can be prepared most easily from dry loam powder mixed with water. If clods of clayey soil are to be used, they have to remain covered with water for some days in large flat containers. After that, slurry can be obtained by using special rakes, as shown in 3.12, or by using electrical hand mixers, as shown in 3.10. A forced mixer usually used for mixing and spraying plaster is more efficient.

Water curing

Water curing is a process by which the wet loam mixture is allowed to stand for a period of 12 to 48 hours. Experience shows that this process enhances the binding force of the loam. This phenomenon is probably due to electrochemical attraction between different clay minerals that forces them into a more compact and ordered pattern.

Thinning

If it is too rich in clay, loam must be made lean. Coarse aggregates like sand or gravel are added, increasing the compressive strength of the loam. The coarse aggregates should always be moistened before being mixed into the rich loam. Besides sand and pebbles, hair, cow dung, heather, straw, husk, sawdust and other similar materials can also be used. These also serve to reduce the shrinkage; some even serve to increase the degree of thermal insulation.

4 Improving the earth's characteristics by special treatment or additives

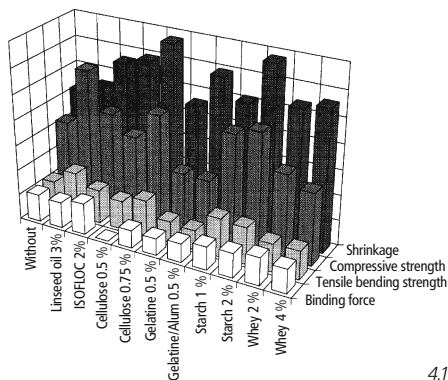

4.1

4.1 Influence of various additives on the shrinkage, binding force, tensile bending force and compressive force of a sandy loam

4.2 Reduction of shrinkage by adding sand to a clayey loam

4.3 Reduction of shrinkage by adding sand to a silty loam

As a rule, it is only necessary to modify the characteristics of loam for special applications. As we can see in 4.1, additives that improve certain properties might worsen others. For instance, compressive and bending strength can be raised by adding starch and cellulose, but these additives also reduce the binding force and increase the shrinkage ratio, which is disadvantageous.

Reduction of shrinkage cracks

Because of increased erosion, shrinkage cracks in loam surfaces exposed to rain should be prevented. As described in chapter 2 (p. 22), shrinkage during drying depends on water content, on the kind and amount of clay minerals present, and on the grain size distribution of the aggregates.

Thinning

Addition of sand or larger aggregates to a loam reduces the relative clay content and

hence the shrinkage ratio. The results of this method are shown in 4.2 and 4.3. In 4.2, a loam with 50% clay and 50% silt content was mixed with increasing amounts of sand until the shrinkage ratio approached zero. To insure comparability, all samples tested were of standard stiffness (see chapter 2, p. 24). Interestingly, a shrinkage ratio of 0.1% is reached at a content of about 90% sand measuring 0 to 2 mm diameter, while the same ratio is reached earlier when using sand having diameters of 0.25 to 1 mm, i.e. at about 80%. A similar effect can be seen in 4.3 with silty loam, where the addition of coarse sand (1 to 2 mm in diameter) gives a better outcome than normal sand with grains from 0 to 2 mm in diameter. Illustration 4.4 shows the influence of different types of clay: one series thinned with sand grains of 0 to 2 mm diameter with 90% to 95% pure Kaolinite, the other with Bentonite, consisting of 71% Montmorillonite and 16% Illite.

Thinning mediums

In the ceramic industry, fluid thinning mediums are used to attain higher liquidity, thereby allowing less water to be used (in order to reduce shrinkage). Typical thinning mediums are sodium waterglass ($\text{Na}_2\text{O} \cdot 3-4 \text{SiO}_2$), Soda (Na_2CO_3), and humus acid and tannic acid. Tests conducted at the BRL at the University of Kassel showed that these methods were of very little relevance to earth as a building material. But tests with whey were successful.

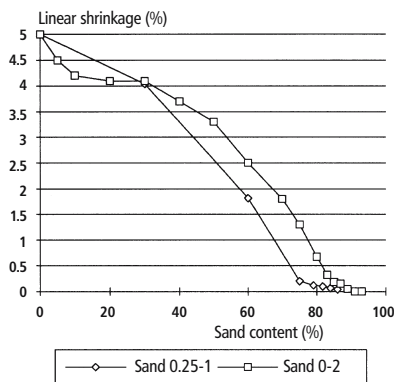

4.2

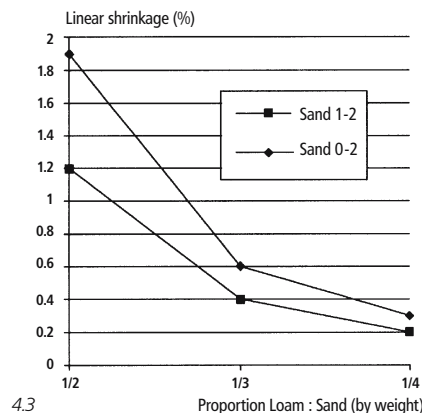

4.3

Addition of fibres

The shrinkage ratio of loam can be reduced by the addition of fibres such as animal or human hair, fibres from coconuts, sisal, agave or bamboo, needles from needle trees and cut straw. This is attributable to the fact that relative clay content is reduced and a certain amount of water is absorbed into the pores of the fibres. Because the fibre increases the binding force of the mixture, moreover, the appearance of cracks is reduced. Some results of tests conducted at the BRL are shown in 4.5.

Structural measures

The simplest method for reducing shrinkage cracks in earth building elements is to reduce their length and enhance drying time. While producing mud bricks, for instance, it is important to turn them upright and to shelter them from direct sunlight and wind to guarantee a slow, even drying process.

Another sensible method is to design shrinkage joints that can be closed separately, and which avoid uncontrolled shrinkage cracks (see chapters 5, p. 56; 8, p. 76; and 14, p. 113).

Stabilisation against water erosion

In general, it is unnecessary to raise the water resistance of building elements made from earth. If, for instance, an earth wall is sheltered against rain by overhangs or shingles, and against rising humidity from the soil through the foundation by a horizontal damp-proof course (which is necessary even for brick walls), it is unnecessary to add stabilisers. But for mud plaster that is exposed to rain, and for building elements left unsheltered during construction, the addition of stabilisers may be necessary. Theoretically, a weather-resistant coat of paint is sufficient as protection, but in practice, cracks often appear on the surface or are created by mechanical action. Further, there is the danger of rainwater penetrating the loam, causing swelling and erosion.

The rule of thumb says that cement and bitumen as stabilisers are good for loam with less clay, and lime for clayey loams. This rule, however, does not take into consideration the type of clay. For instance, Montmorillonite and Kaolinite clay react quite differently, as described in chapter 4, p. 45. The stabilisers cover the clay minerals and prevent water from reaching them and causing swelling. In this chapter, common stabilisers, used traditionally and up to the present, are described. Other stabilisers that mainly increase the compressive strength are mentioned in this chapter, p. 45 and 47.

Water resistance can also be raised by changing the grain distribution of silt and sand, as this author has demonstrated using three mud bricks (shown in 4.6) onto which ten litres of water were poured for a period of two minutes. The brick in the middle, with high silt content, showed extreme erosion up to 5 mm depth. The brick on the right, with a higher clay content (ca. 30%) showed erosion up to 3 mm depth; the brick on the left, with the same clay content, but less fine and more coarse sand, exhibited very little erosion.

Mineral stabilisers (binders)

Cement

Cement acts as a stabiliser against water, especially in soils with low clay content. The higher the clay content, the more cement is needed to produce the same stabilising effect.

Cement interferes with the binding force of the clay and therefore it is possible that the compressive strength of cement-stabilised soil is less than that of the same soil without cement, as shown in this chapter, p. 45.



4.6

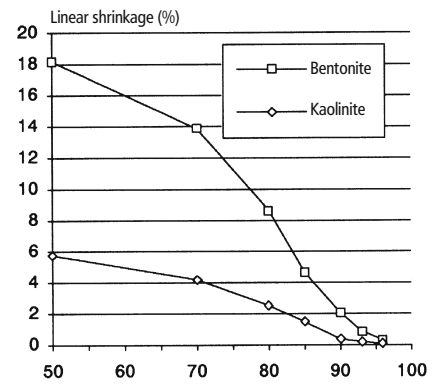

4.4

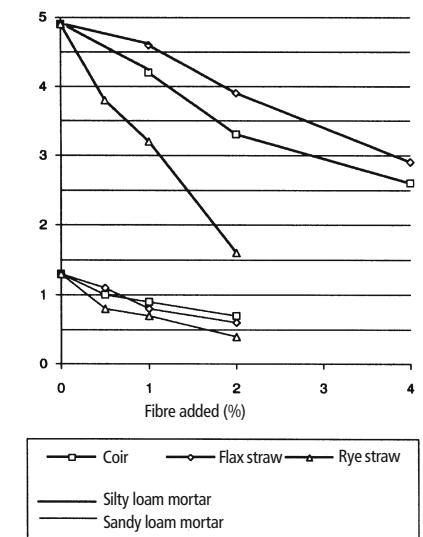

4.5

4.4 Reduction of shrinkage by adding sand to Kaolinite and Bentonite
4.5 Shrinkage ratio of loam mortars with addition of fibres
4.6 Erosion test on green bricks

As with concrete, the maximum water resistance of cement-stabilised soil blocks is reached after 28 days. These blocks must cure for at least seven days, and should not dry out too soon. If not protected against direct sun and wind, the blocks must be sprayed by water while curing.

To hasten and enhance the curing process, 20 to 40 g sodium hydroxide (NaOH) can be added to each litre of water. Similar effects can be obtained with about 10 g per litre of water of either NaSO_4 , Na_2CO_3 and Na_2SiO_2 .

Lime

If there is sufficient humidity, then an exchange of ions takes place in the loam with lime as stabiliser. The calcium ions of the lime are exchanged with the metallic ions of the clay. As a result, stronger agglomerations of fine particles occur, hindering the penetration of water. Furthermore, the lime reacts with the CO_2 in the air to form limestone.

The optimum lime content for loam differs and should be tested in advance in each case. The explanations on p. 43 show that if only a small amount of lime is added, the compressive strength may be lower than that of unstabilised loam.

Bitumen

In Babylon, bitumen was used to stabilise mud bricks as early as the 5th century AD. Normally, bitumen is effective for loam with low clay content. The stabilising effect is more pronounced if the mixture is compressed. For that reason the bitumen is either dissolved in water with an emulsifier such as naphtha, paraffin oil or petroleum. It is preferable to use a mixture of 4 to 5 parts bitumen, 1 part paraffin oil and 1% paraffin, which is prepared by heating to 100°C . Normally, 3% to 6% of this solution is sufficient to stabilise the soil. After the solvent and water evaporate, a film is formed that glues the particles of loam together, thereby preventing water ingress.

Soda waterglass

Soda waterglass ($\text{Na}_2\text{O} \cdot 3\text{-}4 \text{SiO}_2$) is a good stabiliser for sandy loam, but it must be thinned with water in a 1:1 proportion before being added. Otherwise, micro-cracks will occur which generate strong water absorption.

Animal products

Animal products like blood, urine, manure, casein and animal glue have been used through the centuries to stabilise loam. In former times, oxblood was commonly used as a binding and stabilising agent. In Germany, the surfaces of rammed earth floors were treated with oxblood, rendering them abrasion- and wipe-resistant. In many countries, whey and urine are the most commonly used stabilisers for loam surfaces. If manure is used, it should be allowed to stand for one to four days in order to allow fermentation; the stabilisation effect is then considerably enhanced due to the ion exchange between the clay minerals and the manure.

In India, traditional loam plaster (gobar plaster) has a high content of cow dung, which has been allowed to stand in a moist state for at least half a day. This technique is still in use. Investigations carried out at the BRL showed that a loam plaster sample subjected to the jet test (referred to in chapter 2, p. 28) eroded after four minutes, whereas a sample with 3.5% by weight of cow dung began showing signs of erosion only after four hours.

Mineral and animal products

In former times, it was quite common to enhance stabilisation against water by adding lime and manure, or lime and whey. One traditional recipe, for instance, specifies 1 part lime powder mixed with 1 part sandy loam, which is soaked for 24 hours in horse urine, after which it can be used for plastering. Obviously, lime reacts chemically with certain ingredients of the urine, since one the appearance of some fine crystals is observable. The casein in urine and the manure react with lime to form calcium

albuminate (which is not water-soluble). The cellulose in the urine and manure enhances the binding force, as the cellulose fibres act as reinforcement. The ammoniac compounds act as a disinfectant against micro-organisms. Two other recipes successfully tested at the BRL are: (a) one part hydraulic lime, four parts wet cow dung, three days old, and eight parts sandy loam, and (b) four parts hydrated lime, one part fat-free white cheese, and ten parts sandy loam.

Plant products

Plant juices containing oily and latex and derived from plants such as sisal, agave, bananas and Euphorbia herea, usually in combination with lime, are used as a stabilising coating with success in many countries. Investigations at the BRL showed that a high degree of weather protection could be obtained for loam surfaces using double-boiled linseed oil. It must be mentioned, however, that vapour diffusion is heavily reduced in these cases (see chapter 2, p. 29). Several reports show that cooked starch and molasses can also be used to enhance stability. This effect is more pronounced if a little lime is also added.

Artificial stabilisers

Synthetic resins, paraffins, synthetic waxes and synthetic latex are all known to have a stabilising effect on loam. However, because they are relatively expensive, prone to ultra-violet degradation, and because they act as vapour barriers, they are not discussed in greater detail in this book. These stabilisers should be tested before use.

Silane, siloxane, silicones, silica ester and acrylates all have water-repellent effects. They are discussed in greater detail in chapter 12, p. 101.

Enhancement of binding force

The way in which binding force is derived has already been described in chapter 2, p. 32. Normally, no specific binding force is needed with loam as a building material.



4.7

But if the binding force is insufficient, it can be increased by adding clay or by better preparation, that is, by kneading and water curing (see chapter 3, p. 38). Mineral, animal and plant products that are usually added to enhance the weather resistance of loam also normally enhance its binding force, although they may sometimes reduce it. This section explains the various methods by which binding force can be increased.

Mixing and water curing

It is interesting to note that depending upon their method of preparation, different loam samples from the same mix can have different binding forces. If there is enough water for preparation, then kneading, stirring and curing enhance binding force.

At the BRL, it was discovered that after being mixed for ten minutes in a laboratory mixer, a silty mud mortar acquired a binding force that was 57% higher than the same mixture when mixed for only one minute. Nevertheless, there was an 11% reduction in the binding force after 20 minutes, which suggests the existence of an optimum mixing time. The increase in binding force due to a longer preparation time is demonstrated by a simple test. Illustration 4.7 shows two earth balls 5 cm in diameter dropped from a height of 2 m onto a hard surface. Both were prepared to the same consistency, as determined by the plastic limit. The ball on the left was mixed for two minutes, the one on the right for ten minutes. A comparison shows that the sample that was mixed longer demonstrates much less deformation and tended to crack less.

Increasing clay content

A simple method for enhancing the binding force of very lean earth mixes is to add soil with a high clay content or even pure clay.

4.7 Ball dropping test to demonstrate different binding forces
4.8 Modified 'Fuller-Parabola' (Boemans, 1989)

This is easiest if the clay is available in powder form and just mixed into the wet loam. In some countries, Bentonite is available in bags like cement. This consists of 80% to 90% pure clay and contains about 70% Montmorillonite. The dry density of the powder is about 800 kg/m³. It should be kept in mind that while Montmorillonite has a very high bending strength, it also has a characteristically high swelling and shrinking behaviour. It is often easier to get clay powder from ceramic industry suppliers or extremely clayey soils from brick-making plants. Rich clods of clay need to be kept in water to form slurry, and then mixed into the loam with a mixer (see chapter 3).

Additives

The binding force of lean loams can be increased by whey, fat-free white cheese, fresh cheese, urine, manure, double-boiled linseed oil, or lime-casein glue. The results have to be tested in each case before using these additives in a building element. Some of the data compiled by the BRL may be seen in 4.1.

Increasing compressive strength

Loam for building normally has a compressive strength of 20 to 50 kg/cm². The permissible compressive stress for walls according to the German standard DIN 18954 is 3 to 5 kg/cm². In practice, it is very seldom required to enhance compressive strength,

this being necessary only in highly stressed elements used in structures taller than two storeys (which are not permissible by most standards anyway). With earth components, the edge strength against impact is very important and often needs to be increased. Rigidity of corners against breakage depends upon compressive as well as bending tensile strength. This "edge impact strength" is very important during construction, when bricks or blocks are being transported, moved or stacked.

The compressive strength of a loam type depends mainly upon its soil grain size distribution, water content, the static or dynamic compaction imparted to it, and the type of clay mineral present. If the sand and gravel particles are distributed so as to give a minimum packing volume, and the silt and clays are such that the inter-granular spaces of the sand and gravel are fully filled by them, then maximum density (and hence, compressive strength) has been achieved.

Optimum grain size distribution

It is not commonly known that the compressive strength of a mix can be enhanced by merely optimising and varying the proportion of silt, sand and gravel particles, but without increasing the clay content.

In concrete technology, we speak of an ideal grain size distribution, "Fuller parabola," or well-graded mix, given by the expression:

$$a = 100 \sqrt{\frac{d}{D}}$$

where a is the weight of all grains with diameters less than d, expressed as a proportion of the total mass which has the largest grain of diameter D.

Boemans points out that this grading formula is not directly useable for earth construction, since according to it, the clay content given is only 2% to 3%, which is obviously low for earth construction (Boemans, 1989). He claims this formula to be valid only for particles larger than 0.002 mm, while also suggesting a base minimum clay content of 10%. This modification leads to the expression:

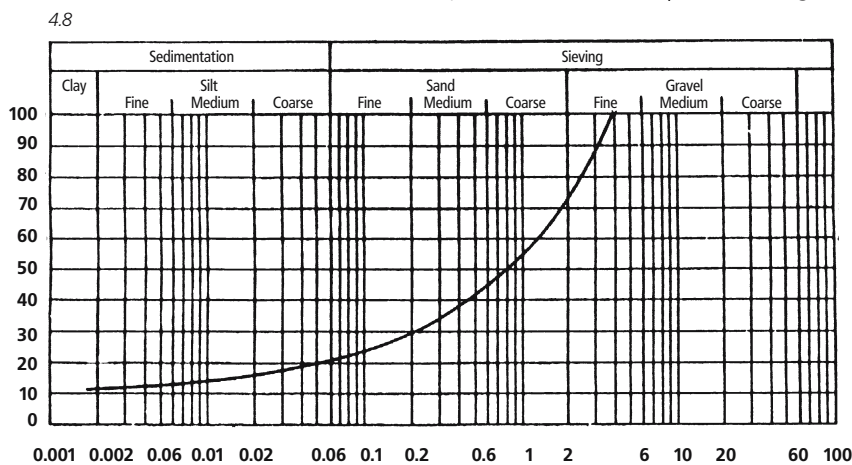

$$a_{10} = 100 \sqrt{\frac{d}{D}} + 10$$

The curve derived from this modified formula for a maximum grain size of 4 mm is shown in 4.8.

Preparation

The compressive strength of a mix is affected by the type and amount of preparation, as well as by the proportion of water used in the preparation, a fact that is neither well-known nor well-researched.

At the Institute for Building Technology of the Swiss Federal Institute of Technology in Zurich and at the BRL, it was proven that a slightly moist loam, when free from lumps and compacted in a soil block press, usually has a smaller compressive strength than the same loam combined with sufficient water, mixed by hand, and then simply thrown into a mould (as is done when making adobes). In one experiment at the BRL, handmade adobes had, on an average, a compressive strength 19% higher than if produced in a soil block press which imparted a pressure of 20 kg/cm² to the material. The belief of many researchers and practitioners that pressing in a soil block press leads to an increase of compressive strength may only be true for limited cases. As a rule, it is not. The "secret" of loam lies in the lamellar structure of the various clay minerals and their internal electrical attraction, which is activated only by water and movement. This means that by kneading loam in a plastic state, the clay minerals are able to come together in a denser, parallel layered packing, achieving greater binding force, and when dry, higher tensile and compressive strength.

Using the compacting apparatus shown in 4.9, developed at the BRL to test samples of equal defined density, cylindrical samples were produced that were 76 mm in diameter and 100 mm in height. The samples were then compacted by ten strokes of a 4.5 kg weight falling onto them from a height of 0.45 m. The volume of a freshly dug earth sample was thus compacted by about 30% to 40%. The same silty soil was

mixed with some water in a mechanical force mixer for two minutes and 15 minutes respectively, and then filled in a cylindrical form of the same size in a pasty state. After drying, the sample that was not compacted had an average compressive strength of 28% and 38% respectively, higher than those that were rammed. This test demonstrates that preparation can be much more relevant to the strength than the compaction. However, it should be noted that the sample mentioned above was silty, whereas this difference is not as large with loams of high clay or sand content.

Compaction

Compacting loam under static force in order to increase its compressive strength is generally less effective than beating or ramming while vibrating (by dynamically applied forces). When a heavy object falls onto it, waves are generated, causing soil particles to vibrate.

This in turn creates movements that allow the particles to settle into a denser pattern. Furthermore, if there is sufficient water, clay minerals have the ability to form parallel, denser, and more ordered structures due to electrical forces, resulting in higher binding and compressive strength.

Loam	Specific weight [kg/m ³]	Vibration [rpm]	Compressive strength [N/mm ²]
silty	2003	0	3.77
	1977	1500	4.11
	2005	3000	4.17
sandy	2003	0	2.63
	2009	1500	2.91
	2024	3000	3.00

4.10

Table 4.10, based on the various tests done by the BRL, shows the comparative effectiveness of dynamic versus static compaction. Here it can be seen that the compressive strength of a sandy loam under constant pressure for ten seconds and vibrating at 3,000 cycles per minute is enhanced by 14%. For each technique of preparation, there is an optimum water content that can be determined only by testing. According to

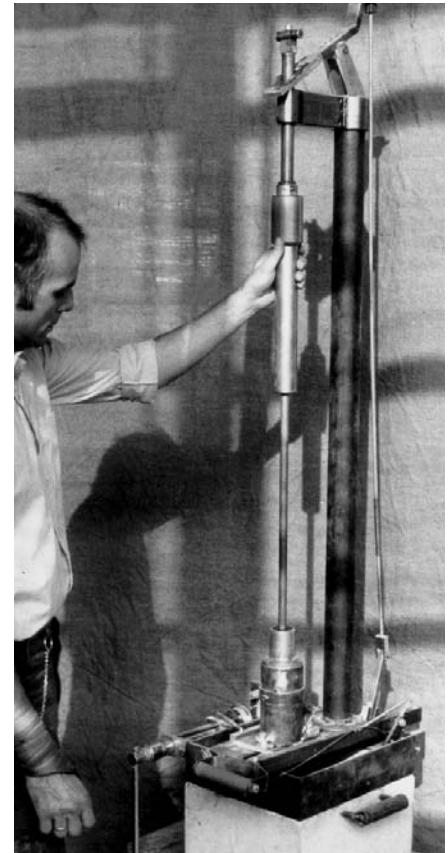

4.9

4.9 Compaction apparatus for soil samples developed at the BRL

4.10 Compressive strengths after static and dynamic compaction of sandy loam (clay 15%, silt 29%, sand 56%) and silty loam (clay 12%, silt 74%, sand 14%)

4.11 Deriving the Proctor Curve with a multi-point method (Voth, 1978)

4.12 Proctor Curves of a silty loam with and without the addition of lime (Voth, 1978)

the German standard DIN 18127, the optimum water content is said to be the one at which a maximum dry density is achieved. The compaction is to be done with a Proctor hammer. In order to obtain this optimum water content, samples with varying water contents are compacted in this way and their densities determined. The water content which gives the highest density is called the optimum water content. The curve obtained by connecting these points is called the "Proctor Curve" (4.11).

In earth construction, however, the maximum density or compaction, and therefore, the so-called optimum water content, do not necessarily lead to maximum density or compaction. Therefore the so-called optimum water content does not necessarily lead to the maximum compressive strength, nor is it the most decisive parameter. On the contrary, the decisive parameters are workability and binding force; hence it is recommended that loam should not be used with optimum water content as per DIN 18127, but instead with a water content somewhat higher than the optimum so derived. In fact, this so-called optimum water content may be treated, in practice, as a minimum water content. With compressed soil blocks, it has been shown that a water content 10% higher than the optimum gives better results than the so-called optimum. Boemans also stated that the optimum water content does not usually result in maximum compressive strength. He also discovered that if there is lesser compaction and higher water, then the same compressive strength may be achieved by using higher compaction and less water (Boemans, 1989, p. 60 ff).

At the Labor Géomatériaux of the Ecole Nationale des Travaux Publics de l'Etat (ENTPE) in Vaulx-en-Velin, France, it was found that the type of clay minerals involved also influence the compressive strength after compaction. For instance, by raising the static pressure from 2 to 8 MPa when producing soil blocks using a press, the compressive strength rose by about 50% with Kaolinite, and by about 100% with Montmorillonite (Oliver, Mesbah, 1985).

Mineral additives

Lean clayey loam can reach a higher compressive strength with the addition of Montmorillonite clay. At the BRL, tests were conducted with sand enriched with 17% by weight of Kaolinite and Bentonite respectively. (Bentonite contains about 70% Montmorillonite). With Kaolinite, the compressive strength reached was 5 kg/cm², and with Bentonite, 12 kg/cm².

The addition of lime and cement, usually intended to increase the weather resistance of loam, also generally increases compressive strength. As described here, however, compressive strength may also be decreased by these additives, especially in amounts lower than 5%. This is because lime and cement interfere with the binding force of clay minerals. The greater the clay content, the higher must be the amount of lime or cement added.

Tests have shown that as a rule, lime offers better stabilisation with rich clayey loams, while cement gives better results with leaner loams. Furthermore, cement is more effective with Kaolinite and lime with Montmorillonite. In practice, it is always recommended that relevant tests be conducted. When doing so, the following points are to be kept in mind:

1. When loam is stabilised with cement or lime, some pores should remain. Only the points of contact of the larger particles should be cemented together, but fewer pores should be filled than with concrete.
2. When the cement hydrates, free lime is formed. This reacts with the silicate acids of the clay minerals so that in addition to the early stabilisation caused by cement, a longer lasting hardening also occurs. Unlike cement concrete, therefore, the strength of cement-stabilised loam increases a little even after 28 days.
3. When adding hydraulic lime, an ion exchange between the clay minerals and the added calcium ions takes place, lasting between four and eight hours. The additional hardening process caused by the reaction of the hydrated lime with the carbon dioxide from the air occurs very slowly.

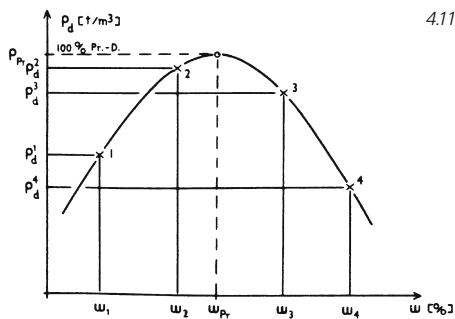

4.11

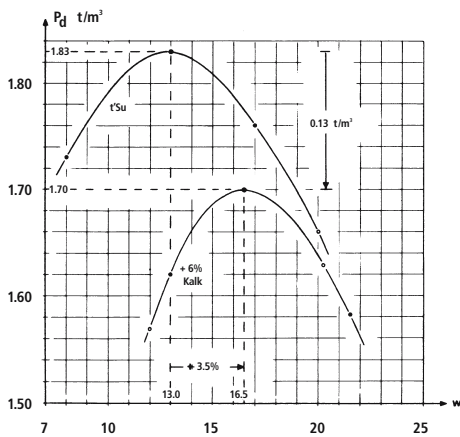

4.12

Even after several months, small increases in strength may be observed. A certain amount of humidity is essential to this curing process, so the loam or earth elements have to be sheltered against direct sun and wind.

4. The optimum water content is raised with the addition of lime, while the density at this new optimum level is less than that without lime (4.12).

Results of experiments performed at the BRL (4.13) show that the compressive strength of a highly silty loam containing 12% clay, 74% silt and 14% sand, and having a compressive strength of 50 kg/cm² without cement, decreases with the addition of small quantities of cement. The original compressive strength is reached again with the addition of 2% cement.

As can be seen in 4.14, this original strength is reached only at 4% when adding lime. In this case, it decreases again after 6% of lime stabilisation.

Even more significant is the reduction of compressive strength while stabilising lean mud mortars, as shown in 4.15 on the right. The left side of the same figure shows the corresponding changes in tensile bending strength. The values of the dry and the wet compressive strengths of handmade adobes with varying percentages of cement content are shown in 4.16.

Investigations at the ENTPE show that testing pure Kaolinite with 4% cement increases compressive strength, while with Montmorillonite, the same amount of cement shows a decrease in strength. With the addition of 4% lime and 2% cement, the compressive strength of both types of clay is increased by nearly 100% (Oliver, Mesbah, 1985). It should be noted that these tests were done with optimum water content and with pure clay. However, in actual practice this increase may not be so high, as loam used in construction usually has a clay content of 5% to 15% and may not be used with optimum water content.

Results of tests conducted at the BRL with handmade adobes are shown in 4.17 and 4.18. Here, four different mixtures of sand

and clay were tested with the addition of 6% cement and lime, respectively. It is interesting to note that the results were nearly the same in the case of sand for plastering and sand with Bentonite. By adding lime to these mixes, the compressive strength of Kaolinite loam is even lower than that containing sand (4.18).

From these investigations, we derive the following guidelines:

1. Loam with high Kaolinite content should be stabilised with cement (and not with lime).
2. Loam with high Montmorillonite content should be stabilised with lime or with a mixture of lime and cement in the ratio 2:1 (and not with cement).
3. Strong compaction increases the compressive strength of Montmorillonite significantly. This effect is significant in Kaolinite. CRATerre suggests appropriate stabilisers

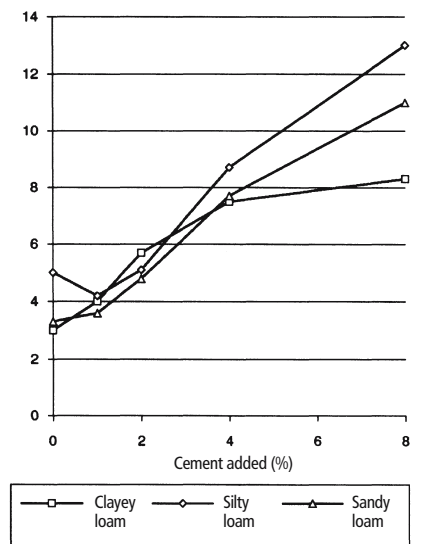

4.13

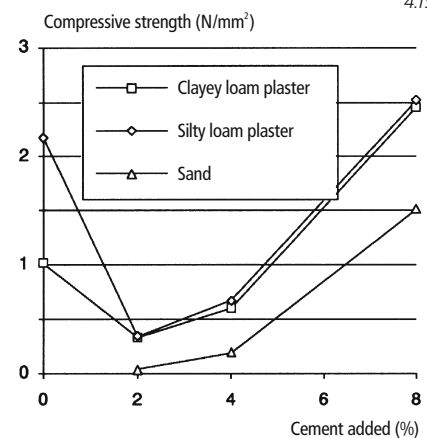
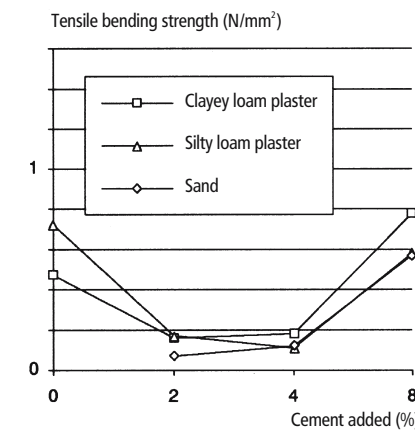

4.15

on the basis of liquid limit, plastic limit and plasticity index (4.19), not taking into account the type of clay minerals (CRATerre, 1979).

When adding cement to loam, the mixture should be used immediately, since the setting of cement starts at once. If the mix is allowed to stand for several hours before being pressed into soil blocks, the compressive strength of these blocks may be reduced by as much as 50%. However, if lime is added, this time lag has no negative influence on the final strength. If less than 5% cement is added, the drying process affects the compressive strength. If the

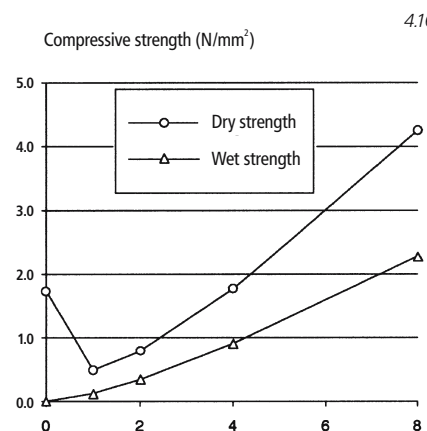

4.16

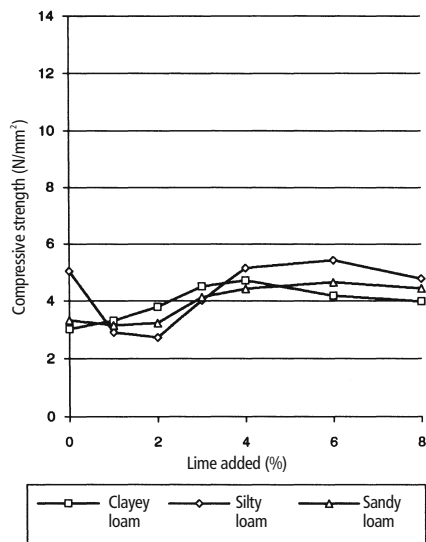

4.14

4.13 Change in compressive strength of loams with the addition of cement

4.14 Change in compressive strength of loams with the addition of lime

4.15 Change in tensile bending strength and compressive strength of loam mortars and sand with the addition of cement

4.16 Change in compressive strength of adobes (clay 11%, silt 14%, sand 75%) with the addition of cement

4.17 Compressive strengths of loams and sand with the addition of 6% cement

4.17

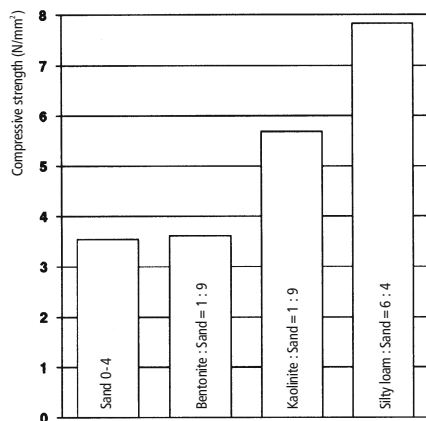

blocks lie exposed to direct sun and wind, so that they dry out sooner, then their final strength may be reduced by 20% compared with blocks kept covered with moist stacking. If this moist cover is not possible, the blocks should at least be protected from direct sun and sprinkled with water several times a day. When 10% cement is added, this protection is of less relevance to the final strength (Houben, Guillaud, 1984). If pozzolana is added together with lime, an additional stabilisation effect is achieved and the quantity of lime can be reduced. Certain volcanic ashes exhibit pozzolanic properties, as do fly ash and ash of rice husk. Brick dust from low-temperature baked bricks also exhibits slight pozzolanic properties, but dust of high-temperature baked bricks from industrial brick plants do not. An interesting stabilisation effect is observed when clay, chalk and quartz powder are mixed with waterglass. This product, called geopolymer, is derived from poly-condensation: a three-dimensional network, which occurs in an alkaline state with the release of water. This product may be extruded, pressed or foamed with hydrogen peroxide (H₂O₂).

Organic additives

The compressive and binding strengths of Kaolinite can be significantly increased by adding urea and ammonium acetate (Weiss, 1963). Weiss also suggests that the high strength of porcelain comes from Kaolinite soaked in putrid urine (which contains urea and ammonium acetate). The tensile bending force can be increased approximately 10 to 20 times in this way.

Addition of fibres

Fibres are usually added to reduce shrinkage. The oft-mentioned assumption that fibres always increase compressive strength is false. When fine fibres or hair are added in small amounts, tensile strength – and therefore compressive strength – is increased slightly. The addition of cut straw, however, has the opposite effect, as shown by investigations carried out at the BRL (see table 4.20).

Strength against abrasion

Experiments conducted at the BRL intended to increase the strength of a rammed earth sample containing 14% clay, 41% silt and 45% sand, and involving the addition of soda waterglass, animal glue, low-fat white cheese and lime, paraffin, paraffin-petroleum, floor wax, and double-boiled linseed oil, showed that an addition of 10% waterglass produced the most resistant surface. However, several hairline cracks occurred, allowing water to penetrate. (It may have been possible to avoid this had the waterglass been mixed beforehand with water in a proportion of 1:1.)

The second highest strength was achieved by adding 5% linseed oil, whereby the surface was smoothed with a trowel during curing, closing hairline cracks in such a manner that the surface remained glossy. The third-best solution was achieved by adding 5% low-fat white cheese and 5% lime.

Strength against abrasion can also be increased with coatings. Here, it must be kept in mind that the coatings must penetrate deep into the material and must be renewed periodically. Experiments show that coatings and additional application of floor wax increase abrasion resistance considerably.

A traditional German recipe that produces a hard-wearing, strong surface is a coating of oxblood sprinkled with Fe₃O₄, which is then hammered into the loam surface. Coatings of cow's blood, cow's bile and tar were also frequently used in former times.

Increasing thermal insulation

The thermal insulation of loam can be increased by adding porous substances such as straw, reeds, seaweed, cork and other light plant matter. Naturally or artificially foamed mineral particles like pumice, lava, expanded clay, foamed glass, expanded perlite and foamed plant matter like expanded cork can also be added. Waste products like sawdust, wood shavings, husk

of grains can also be used, but given their higher density, they exhibit inferior insulating properties. The more porous the mixture, the lighter it is and the greater its thermal insulation.

According to the German standard DIN 18951, loam with lightweight aggregates is called lightweight loam if its density is less than $1,200 \text{ kg/m}^3$. If straw is used as the filler, it is called lightweight straw loam, while sawdust or wood shavings are referred to as lightweight wood loam.

Porous mineral aggregates are called lightweight mineral loam. Since these three types of lightweight loams differ in their properties and methods of manufacture, they are described separately.

Rich clayey slurry is used to produce these lightweight loams. The process of making slurry depends upon the specific loam mixture that has been found, and can be performed either manually or mechanically, as described in chapter 3, p. 38.

In theory, it is also possible to use loam that has been blown up or expanded with foam-creating substances to form air-filled pores. To date, tests with loam have failed to do produce corresponding results.

Lightweight straw loam

General

Lightweight straw loam is a mixture of straw and loam with a density of less than $1,200 \text{ kg/m}^3$. If this density is higher than $1,200 \text{ kg/m}^3$, it is called straw loam. There is worldwide debate over which type of straw is most suitable, and it should be tested in each case. For loam plaster, however, barley straw has proven to be suitable, since it is usually softer than the other straws. More important than the kind of straw is the structure of its shoots. In order to increase thermal insulation, straws with rigid shoots are preferred, since they do not deform easily, and hence keep air trapped inside.

Cutting straw

The length of the straw shoots should be no greater than the thickness of the building

element. Cutting can be managed by a variety of manual or mechanical methods.

Preparing the mixture

Loam and straw is mixed together either by pouring the slurry over the straw or by dipping the straw into the slurry. The straw shoots must be totally surrounded by loam slurry. Chapter 10, p. 83 describes how this mixture is handled subsequently for various applications.

Thermal insulation

One widely held misconception is that straw loam used as infill in medieval timber-framed houses in Europe provided sufficient thermal insulation. If 10 parts of cut straw are mixed with thick loam slurry made of 2 parts of dry clayey loam and 1 part of water, this will give a mixture with a dry density of about $1,300 \text{ kg/m}^3$ and a k-value of about 0.53 W/mK . Thus, a typical element of this material with a thickness of 14 cm covered with 2 cm lime plaster on both sides gives a U-value of $2.1 \text{ W/m}^2\text{K}$. On the other hand, if a U-value of $0.5 \text{ W/m}^2\text{K}$ is to be achieved (as generally desired or required by building codes in most central and northern European countries today), then this wall would have to be 0.95 m thick. Even if the straw content were to be increased threefold, this material is unacceptable for a thickness of 14 cm.

In practice, it is almost impossible to achieve a density less than 500 kg/m^3 , since the straw is softened by moistening caused by the mixing process, and is compacted when placed in the formwork.

There have been claims of lower density (as low as 300 kg/m^3), but these are not usually correct, since they are often based on or produced by inaccurate testing methods. Typically, a small brick-size formwork is loosely filled with a straw loam mixture. This is then weighed after drying and divided by the volume of the mould, which can lead to errors of about 40%. The only accurate method of determining density is to saw-cut a cuboid out of a larger block (especially in height) so that the straws bent at the cor-

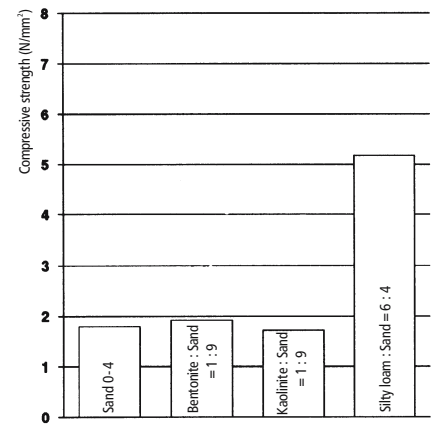

4.18

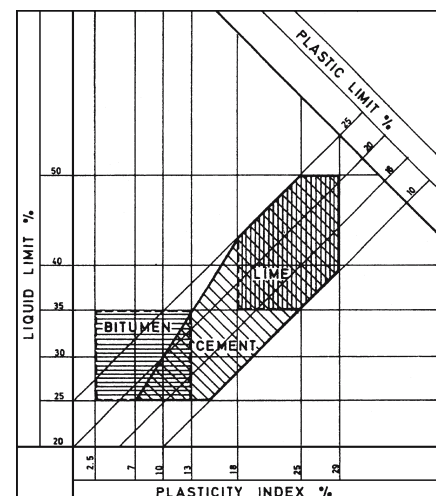

4.19

4.20

Straw [%/mass]	Weight [kg/m ³]	Compressive strength [N/mm ²]
0	1882	2.2
1	1701	1.4
2	1571	1.3
4	1247	1.1
8	872	0.3

4.18 Compressive strengths of loams and sand with the addition of 6% lime

4.19 Suggested appropriate stabilisers for loam in relation to their plasticity (CRATerre, 1979)

4.20 Reduction of the compressive strength of loam by adding cut straw (5 cm)

ners as well as the air spaces left around the edges of the mould are eliminated. The larger the sample, the greater the accuracy, since there is always some edge erosion during cutting and handling.

Due to the above-mentioned errors, unfortunately, densities of as low as 300 kg/m³ tend to be assumed and the k-value computed accordingly. Since, in reality, densities are typically about 700 kg/m³ in built sections, the k-value of this is 0.21 W/mK, from which, for a 30-cm-thick wall plastered on both sides, the U-value can be derived as 0.6 W/m²K. This value of heat transmission is double the value that can be claimed by assuming a density of 300 kg/m³.

The following points are to be kept in mind when working with lightweight straw loam, for lightweight straw loam has certain undeniable disadvantages in comparison with pure loam:

1. In a moderate or humid climate, fungus growth occurs after only a few days, emitting a characteristic strong smell. This can, in extreme cases, give rise to allergies. Therefore, good ventilation during construction must be provided so that building components dry out quickly. After the walls have dried completely, which might take several months, or even a year or more, depending upon thickness and climate, the fungus stops producing spores. However, spore formation may be reactivated if water permeates the walls either from the outside through leakage, or from inside through condensation. Fungus growth can be inhibited by adding lime or borax, but this has the following disadvantages:

- binding force and compressive strength are significantly decreased,
- hands become irritated while working with this mixture.
- Walls thicker than 25 cm may appear dry on the surface, even though they are rotting within (see chapter 10, p. 83).

2. The surface strength of the mix for a wall with a density of less than 600 kg/m³ is usually too low to effectively grip nails or dowels, as is often required. Since two layers are necessary, plastering is more laborious,

sometimes with some reinforcement in between.

3. When drying, vertical settling occurs, leading to gaps on top of wall elements (4.21). These must carefully be filled later on in order to prevent heat and sound bridges and air infiltration.

4. Working with this material is fairly laborious. Without special machines for mixing and transportation, the labour input for a typical 30-cm-thick wall is about 6 h/m² (20 h/m³). This is four times the labour required for typical brick masonry work.

The disadvantages mentioned above can be avoided if porous mineral aggregates are used instead of straw, as discussed in the following section.

The potential advantages of lightweight straw loam are the low material costs involved, and the fact that it can be worked without investments in special tools and machinery. It is especially appropriate, hence, for do-it-yourself construction.

Lightweight mineral loam

In order to increase thermal insulation, porous mineral aggregates can be added to loam as an alternative to straw; these include expanded clay, foamed glass, expanded lava, expanded perlite and pumice. It is possible to achieve a shrinkage ratio of 0 (i.e., to eliminate shrinkage altogether) by choosing the right proportion of aggregates. All other techniques of earth construction require consideration of shrinkage.

In comparison with straw loam, the vapour diffusion resistance is two to three times higher and, therefore, the probability of condensation of water within the wall is low (see chapter 2, p. 29).

Another advantage of the material is that the mixture can be pumped into a formwork, thereby greatly reducing labour input. As investments on machines are higher, this method is recommended only for larger construction projects. The densities generally achieved vary from 500 to 1,200 kg/m³.

Additives

In some industrialised countries, expanded clay is a low-cost and easily available additive. It has a bulk density of about 300 kg/m³, and is produced by burning loam in rotary ovens at temperatures up to 1200°C without any other additive for foaming.

Foaming occurs due to the sudden heating, which causes the water of crystallisation and the pore water to evaporate, creating an expansion in the mass (similar to making pop-corn). The surface of these expanded clay balls melts and is sintered. Nearly all of the pores in these expanded clay balls are closed, and are therefore unsusceptible to water and frost. The equilibrium moisture content by volume is only 0.03%.

Foamed glass has characteristics similar to expanded clay, but has a lower bulk density. It can be produced by recycling glass with additional foaming agents.

Expanded perlite is produced from volcanic rock (found in Europe, on the Greek island of Milos and in Hungary). It contains 3% to 6% chemically bound water, and when it is heated up suddenly to 1000°C, this water evaporates and enlarges the former value 15 to 20-fold. The bulk density may be as low as 60 kg/m³, the k-value is 0.045 W/mK. The vapour diffusion resistance is about 2.7. The specific heat is 1000 J/kgK. With a material of bulk density 90 kg/m³, a k-value of 0.05 W/mK is achieved. The chemical composition of expanded perlite is: SiO₂ (60-75%), Al₂O₃ (12-16%), Na₂O (5-10%).

Expanded lava is similar to expanded perlite of volcanic origin, except that its bulk density is higher.

Pumice is a naturally porous stone that has already been "expanded" during its formation in a volcano. Its bulk density usually varies from 500 to 750 kg/m³.

Mixing

While forced mixers are usually required to produce loam mixtures (see chapter 3, p. 37), lightweight mineral loam can be produced in an ordinary concrete mixer. There, aggregates can be placed in advance and

the loam slurry poured over it. The mix is ready in three to five minutes. The slurry needs to have a rich clay content and binding force. The production of loam slurry is described in chapter 3, p. 38.

Grain size distribution

The grain size distribution of mineral aggregates affects the properties of lightweight mineral loam. For example, a density as low as 500 kg/m³ can be reached with expanded clay fractions of 8 to 16 mm diameter.

The quantity of loam slurry has to be designed so that the volumes between aggregate particles are not completely filled, that is, the aggregates are only glued together at points of contact. This density of 500 kg/m³ can be reached if 2.5 parts of loam are added to 12 parts of expanded clay (8 to 16 mm). However, blocks of this mixture have a low edge and surface rigidity. A stronger mixture is obtained with 24 parts expanded clay (8 to 16 mm), 5 parts expanded clay (1 to 2 mm), and 5 to 7 parts loam. The density reached by this mixture will be 640 to 700 kg/m³. To achieve higher density, expanded clay fractions 4 to 8 mm can be chosen, adding enough loam to fill all spaces between the aggregates. In this case, it is advantageous to thin the loam with coarse sand.

Handling

Lightweight mineral loam, unlike lightweight straw loam, can be poured or even pumped if the mix is chosen accordingly. The methods of preparing and handling this mixture are explained in greater detail in chapter 10.

Thermal insulation

The thermal insulation properties of lightweight mineral loam depend mainly on its density and are equal to that of lightweight straw loam if the density is higher than 600 kg/m³. For mixtures below 600 kg/m³, the thermal insulation properties of lightweight mineral loams are somewhat better than those of lightweight straw loams, since straw has a higher equilibrium moisture content, and therefore more moisture,



4.21

4.21 Setting of a lightweight straw-filled test element

which reduces insulation. The equilibrium moisture content of rye straw at a relative humidity of 50% and a temperature of 21°C, for instance, is 13%, whereas under the same conditions, it is only 0.1% in the case of expanded clay.

Embodied energy

It is often argued that artificially foamed mineral aggregates like expanded clay require considerable energy for production. In this context, one should be aware that the embodied energy of timber or bricks used in construction is much higher. The embodied energy of timber is computed to be 6 times as high as that of mineral wool, and twice as high as expanded clay for the same volume (Turowski, 1977; Weller and Rehberg, 1979; Elias, 1980; Marmé and Seeburger, 1982).

In making an overall assessment of the construction energy entailed by a given project, then, we must remember that while it may be technically true that loams with artificially expanded minerals use more energy than those containing other aggregates, this difference is negligible when compared, for instance, to the total energy input involved in the processing, production and transportation of timber.

Lightweight cork loam

Expanded cork can be used to form lightweight loam in place of porous mineral aggregates. The advantage of expanded cork is its low density. The disadvantage is that this material is relatively expensive and has little compressive strength. Therefore, bricks made of this mixture break very easily at their edges.

The German firm Haacke developed a mixture of cork, diatomite, and straw, along with some cellulose, which can be sprayed on a wall like an insulating spray plaster. Density is between 300 and 450 kg/m³. The measured k-values are 0.07 to 0.08 W/mK, measured vapour diffusion resistance between 4 and 19, and shrinkage ratio between 1% and 2%.

Lightweight wood loam

Sawdust, wood shavings and chips can also be used as lightweight aggregates to increase the thermal insulation capacities of loam. As timber has a higher density than straw or cork, the thermal insulation of that mixture is obviously lower. The minimum density that can be achieved is about 500 kg/m³, but a dry mix of this density no longer possesses sufficient rigidity. The danger of fungus growth and rotting is much less than with straw, but it still exists.

It is ecologically desirable to use chips made of branches and portions of trees not otherwise used in structural work. However, these contain fairly large quantities of bark, and are therefore susceptible to fungus growth and rotting.

Foamed loam

In order to foam loam, it has to be free of sand and gravel, and in a plastic state. As loam in this consistency needs a long period to dry, it is hardly possible to foam it using the regular agents such as those used for foaming concrete. Therefore, the loam needs to be given additives which quicken the drying process, such as the geopolymers described in this chapter, p. 43, in which clay, quartz and chalk powder are mixed with waterglass and foamed with hydrogen peroxide (H₂O₂). This process produces a foamed loam with a density of 90 kg/m³. This material hardens within two hours at a temperature of 20°C and in one hour at 50°C. This product, manufactured by the German firm Hüls AG, has a compressive strength of 10 to 20 kg/cm², specific heat of 0.2 kJ/kgK, thermal conductivity of 0.10 to 0.12 W/mK and pH-value between 9 to 10. It is an ideal material to form pre-cast earth elements of a large size. The German company Lorowerk uses a similar technique to produce large elements for thermal insulation. Products with densities of 300 kg/m³ reach a thermal conductivity of 0.08 W/mK. The primary energy input is only 5 kWh/m³.

5 Rammed earthworks

5.1 Formwork for rammed earth
5.2 Climbing formwork, BRL (Minke, 1984)

On all five continents, rammed earth has been well-known for centuries as a traditional wall construction technique. In fact, rammed earth foundations found in Assyria date back as far as 5000 BC.

With rammed earth techniques, moist earth is poured into a formwork in layers of to 15 cm thick, and then compacted by ramming. The formwork usually consists of two paral-

lel walls separated and interconnected by spacers (5. 1). This technique is called *pisé de terre* or *terre pisé* in French; the Spanish names is *barro apisonado* or *tapial*; and the German words is *Stampflehmbau*.

Traditional rammed earth techniques are still used in many developing countries. Refined formwork systems and electrical or pneumatic ramming reduces labour input significantly and makes rammed earth techniques relevant in some industrialised countries as well. For ecological, and sometimes for economic reasons as well, mechanised rammed earth technology may be a viable alternative to conventional masonry especially in those industrialised countries where high standards of thermal insulation are not required. Many firms employ this technology in the southwestern USA and in Australia.

In comparison with wet loam techniques (see chapter 9), the shrinkage ratio of rammed earth is much lower, and strength much higher. In comparison with adobe masonry (see chapter 6), rammed earth – since it is monolithic – provides the advantage of longer life.

Techniques for rammed earth wall and dome construction are described in the following sections. A special earthquake-resistant bamboo-reinforced rammed earth technique as well as rammed earth floors are described in chapter 15.

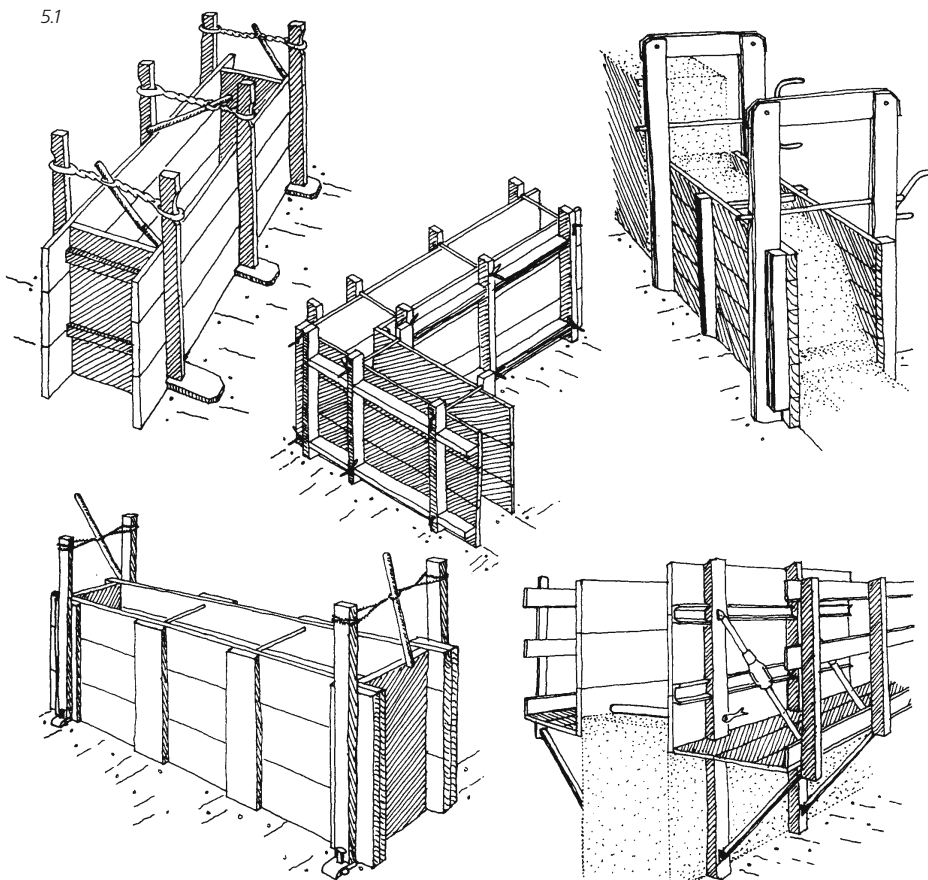

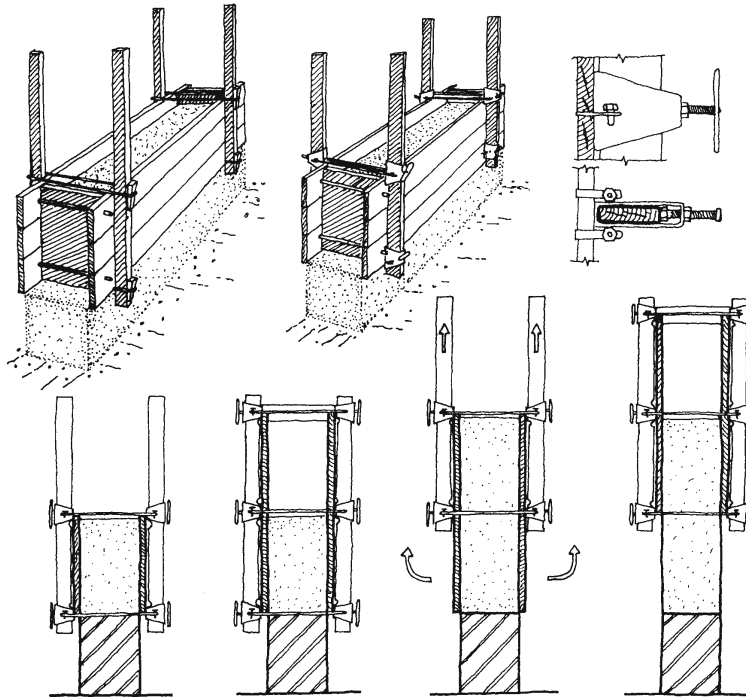

5.2

5.3 Formwork without intermediary spacers

5.4 Typical formwork with bracing used in China

5.5 Formwork for rounded and curved walls

Formwork

With traditional formworks, the boards on both sides are held apart and kept together by spacers (5.1). These spacers pierce the wall, causing openings that must be filled in after removal of formwork. A system with very thin tensile spacers (4 x 6 mm) penetrating the wall has been developed at the Building Research Laboratory (BRL) (5.2). In order to completely eliminate this disadvantage, spacer-free systems have been

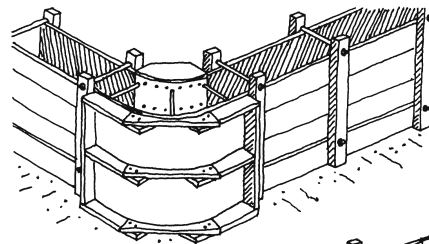

5.3

5.4

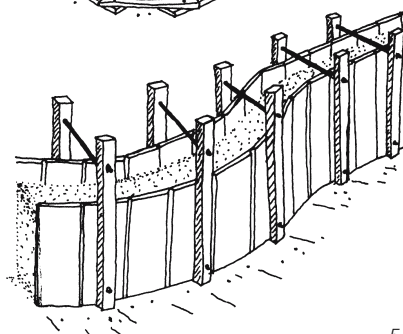
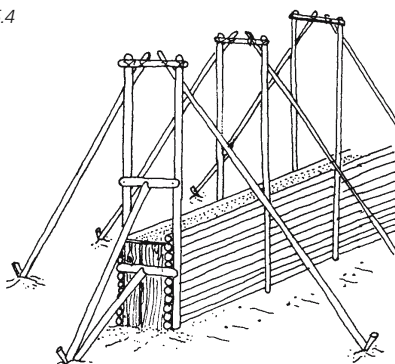

5.5

developed (see p. 56 in this chapter).

As shown in 5.4, formworks without intermediary spacers which are braced on both sides require a lot of space and hinder site movement considerably.

With a special formwork, rounded corners and curved walls can also be formed (5.5). A circular barn built in 1831 in Bollbrügge, Germany, with 90-cm-thick rammed earth walls is shown in 5.6.

Common formwork systems used in concrete technology can also be used for rammed earth, but usually turn out to be too heavy and expensive. In Europe, timber panels of 19 mm thickness are commonly used. They need to be stiffened by vertical members at approximately 75 cm intervals. If this is not done, they will bend outwards during ramming. Therefore, it might be more economical to choose thicker boards of 30 to 45 mm thickness, which need stiffening only at intervals of 100 to 150 cm.

If the soil is very clayey, the form should not be wrenched off, but instead slipped off the rammed earth smoothly along the surface, thus preventing it from being spoiled by clayey particles sticking to the form. Furthermore, it is neither desirable to have a surface that is too rough (such as saw-cut timber), nor one that is too smooth (such as varnished and planed timber).

If the formwork is not optimised for this technique, then up to 30% of total labour input could be invested simply in erecting, adjusting, and dismantling the formwork. Therefore, the following points should be borne in mind:

- Boards must be stiff so that they do not bend outwards while ramming is underway.
- All parts must be light enough to be carried by two workers.
- The formwork should be easy to adjust in both vertical and horizontal directions.
- Variations in the thickness of the wall must be controllable within a specified tolerance.
- It is preferable that the edges require no special formwork. Therefore, the formwork should allow varying lengths of wall to be cast.



5.6

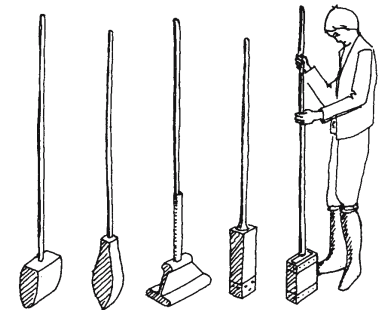

5.7

Tools

In former times, earth was rammed manually, using rams with conical, wedge-shaped or flat bases (5.7).

If conical or wedge-shaped rams are used, the different layers are better mixed and, provided there is sufficient moisture, a better bond is obtained. However, this takes more time than ramming with flat-based rams. Walls rammed with flat-based rams show less lateral shear resistance and therefore should only be loaded vertically.

The base of the ram should not be too sharp, so that the formwork, if made of timber, is not damaged. The base should be no smaller than 60 cm², and no larger than 200 cm². The weight of the ram should be between 5 and 9 kg. It is preferable to use a two-headed ram with a round head on one side and a square one on the other. This allows the ram to be used with the round side for general work, and with the square edge to compact corners effectively. Such a ram is used even today in Ecuador (5.8).

Electric and pneumatic rams were used as early as the second quarter of the 20th century in Germany, France and Australia. The electrical ram shown in 5.9, built by the Ger-



5.8

man firm Wacker, was often used in former times for rammed earth work, and has been written about extensively. It has a hammer-like action with a lift of 33 mm, and a frequency of 540 strokes per minute. The ram is very effective; its only disadvantage being difficult in handling, since it weighs 24 kg. It is no longer manufactured.

In Australia in the 1950s, a pneumatic ram was used (5.10). This acts like a jackhammer, has a frequency of 160 strokes per minute, and weighs 11 kg.

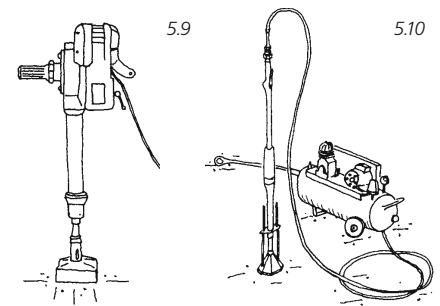

5.9

5.10

5.6 The circular barn, Bollbrügge, Germany (1831)

5.7 Rams used for manual compacting
5.8 Two-head ram used in Ecuador



5.13

- 5.9 Electrical ram (Wacker)
- 5.10 Pneumatic ram, Australia
- 5.11 Pneumatic rams (Atlas-Copco)
- 5.12 Vibrating ram (Heuser)
- 5.13 Vibrating ram (Heuser)
- 5.14 Shrinkage cracks in a rammed earth wall, Ecuador
- 5.15 Slicing rammed earth directly after the formwork is dismantled
- 5.16 The French *pisé* technique

Normally, soil compaction tools of the type used in road construction are unsuitable for rammed earthwork, because their frequency is too high and their lift too low. Tools which only vibrate might be suitable for sandy soils, but not for clayey ones.

The pneumatic rams shown in 5.11 are extremely effective for rammed earthwork. The Ram II G, produced by the firm Atlas-Copco, is fairly suitable because a special feature prevents its head rotating, thus ensuring that square heads can also be conveniently used. All the rams illustrated require a pressure of 6 bar and an air flow rate of 0.4 to 0.9 m³/min. Due to their high costs and the infrastructure and energy required to run them, these rams are used only for larger building projects. An electrical vibration ram has been developed at the BRL and manufactured by the firm Heuser (5.12 and 5.13). Its engine has a frequency of 1000 to 1200 cycles per minute. The most important part of this vibrating ram is its specially shaped base, which allows the apparatus to move within the formwork by itself while compacting the earth. It can compact loose soil in layers 7 cm thick.

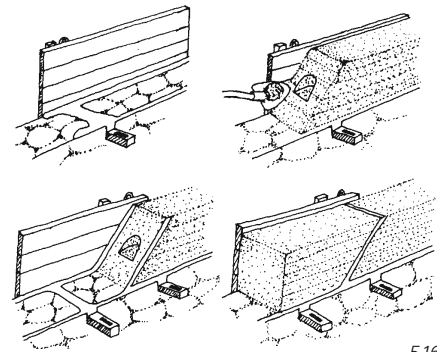

5.16

the upper course than in the lower, leading to horizontal shrinkage cracks at the joint (5.14). This can be dangerous, since capillary water can enter this joint and remain, causing swelling and disintegration. As can be seen in the same figure, vertical cracks can also occur in such walls.

With the French *pisé* technique, this problem was solved by using a layer of lime mortar above each course before laying a new one. A lime mortar cures over several weeks and remains plastic until the loam has stopped shrinking; sometimes even the side joint between sections of the course is made with mortar at an incline (5.16).

Another method to avoiding horizontal shrinkage cracks is to ram in a way that the wall is produced vertically. This is described in greater detail below.



5.11

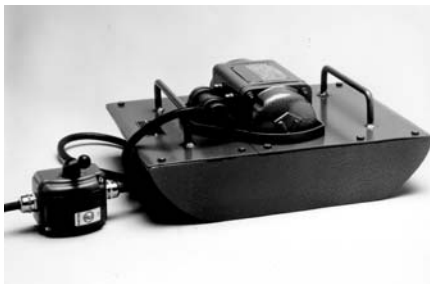

5.12



5.14



5.15

Method of construction

In nearly all traditional rammed earth techniques, the formwork is removed and re-erected horizontally step by step. This means that earth is rammed in layers from 50 to 80 cm high, forming courses of that height before the formwork is moved. When one course is complete, the next course that is rammed is moister than the one already in place, which is partially dried out. Therefore, there is a higher shrinkage in

Shaping of openings

The formwork can be dismantled immediately after ramming is completed. At the same time, this rammed earth can be shaped easily by scraping, cutting, scooping or scratching. Normally, inserts are left in the formwork to create openings. However, with rammed earth, the opening can be cut with much less effort with a knife or a barbed wire used as a saw. This technique also allows shaping of jambs and sills, as shown in 5.15. It should be mentioned that at this stage rammed earth has already achieved sufficient strength to grip nails (they can be driven into the wall without making a guiding hole with a drill).

New wall construction techniques

Rammed earth panels

In order to prevent horizontal shrinkage cracks at the vertical joints in traditional rammed earth construction, a new technique was developed at the BRL for producing one-storey-height panels, with widths of up to 2.4 m, in a continuous ramming process. This technique avoids horizontal joints, and the vertical joints that occur are closed only after the shrinkage is complete. For lateral stability, the vertical joints are made in a tongue-in-groove pattern. No shrinkage cracks occur within the panels for these sizes. The reduction of length due to shrinkage is only visible at the joint. (The joint acts like a pre-designed contraction joint). In order to avoid a formwork that would have to be an entire storey in height, a slip form was developed at the BRL. Illustration 5.19 shows the design in steel, while 5.17 and 5.18 show a later design in wood (which proved easier to work with). The formwork is spaced at the bottom with only a steel bar, which leaves a very small hole after dismantling. The top space is positioned above the top level of the wall and does not interfere with the process. As the figures show, it is possible to use either a simpler solution with a timber spacer on top fixed to the vertical members, thus forming a yoke, or a more sophisticated version made from steel, which also allows fine adjustments of distance at the top. The first building using this technique was built at the University of Kassel in 1982 (5.21). The soil contained about 10% clay and about 50% sand. The earth was rammed by the vibrator described on p. 55 and shown in 5.12 and 5.13. The linear shrinkage of these elements was only 0.4%. After drying, the joints were filled with a loam stabilised with 8% double-boiled linseed oil. A roof overhang of 60 cm and a plinth of 50 cm were sufficient to ensure that the wall did not erode and that it required no surface treatment.

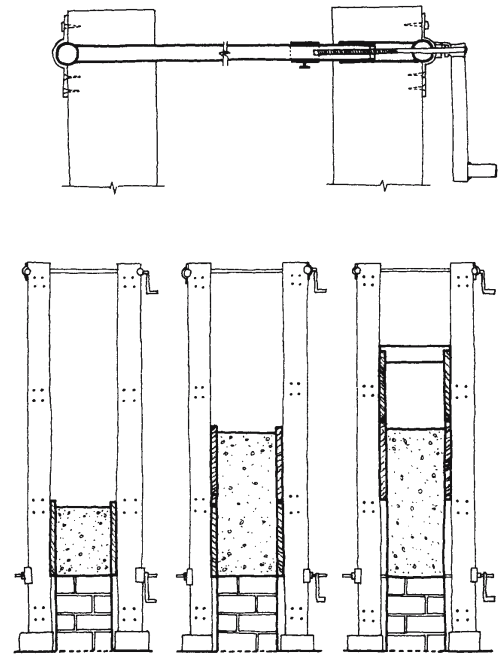
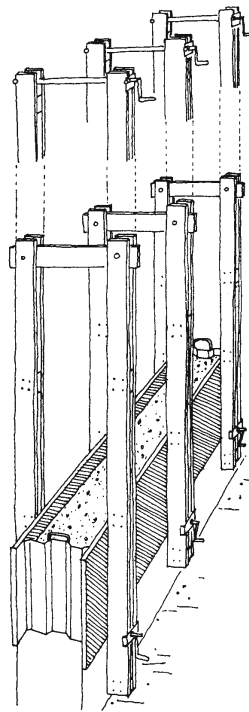

5.17

Highly mechanised techniques

The firm Rammed Earth Works has built several rammed earth houses in California utilising a special formwork made of thick plywood, as shown in 5.20. Earth was filled into the forms by a dumper and compacted by a pneumatic ram. By this means, the labour input could be as low as 2 h/m³. In Australia, several firms are also using this type of highly mechanised construction process (5.22 and 5.23). In recent decades, more than a hundred rammed earth buildings have been constructed on the Australian continent (Oliver, 1985). Illustration 5.24 shows a church in Margaret River designed by Hodge and Wilson and built by the firm Ramtec. As seen in 5.25, even the columns supporting the roof structure are made from rammed earth. In 1992, the Kooralbyn Valley Resort Hotel was built in Australia (architects: I. Hannaford, F. Raadschelders, D. Oliver), where all walls are made of unplastered rammed earth (5.27 and 5.28).

5.17 to 5.19 Sliding formwork for rammed earth panels (BRL)
5.20 Formwork (Rammed Earth Works, USA)
5.21 Test building, University of Kassel, Germany, 1982
5.22 to 5.23 Mechanised rammed earth-work in progress (Terrastone)



5.18

Frame structure with rammed earth infill

At the Centro de Pesquisas e Desenvolvimento, (CEPED) in Salvador, Brazil, a simple technique was developed to construct thin rammed earth infill panels. It was used in several low-cost housing projects in Brazil. The posts and ring beams were normally made from pre-cast reinforced concrete. The sides of the formwork were directly mounted on the posts. Thus, the thickness of the wall was the same as that of the post (5.26). In this case, the loam was stabilised with 6% to 8% of cement.

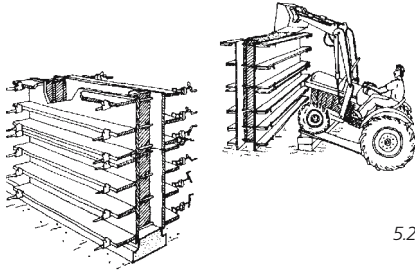

5.20

Wall construction with lost formwork

As with rammed earth techniques, the cost of the formwork is quite high. In some cases, it is preferable to use a thin masonry wall or stiff thermal insulation elements made of wooden materials as lost formwork, so that either no formwork or only

one-sided formwork is required. It is also advantageous if this formwork can contribute to a substantial increase in thermal insulation. The stiffness of this lost formwork has to be sufficient to take care of the lateral impacts created by ramming. Illustration 5.29 shows horizontal sections through an external wall. The first two cases show an inner leaf built of adobes or soil blocks and an outer rammed earth layer made with lightweight mineral loam which is directly plastered. In this case the formwork is only required for the outer face. In the second case, a somewhat better stiffness of the inner adobe or soil block leaf is attained due to the bonding pattern in the components. In the section shown on the right, the lost formwork is on the outside and is made from stabilised lightweight soil blocks.

Illustration 5.30 shows vertical sections of external walls that have lost formwork on both sides. The inner leaf can be made from adobes or soil blocks, larger pre-fabricated loam elements, or stiff plywood boards, fibre-reinforced gypsum boards, or Magnesite or cement-bonded wood particleboard.

Protection of the wall surface against the elements can be achieved by plaster, masonry or timber panelling with air cavity.



5.21



5.19



5.22



5.23



5.24

5.24 to 5.25 Church,
Margaret River, Aus-
tralia

5.26 Framed structure
with rammed earth
infill (CEPED, Brazil)

5.27 to 5.28 Hotel,
Kooralbyn, Australia

5.29 Horizontal
sections of rammed
lightweight loam walls
with inner or outer
leaf of earth blocks
acting as lost form-
work

5.30 Vertical sections
of rammed earth walls
with lost formwork
on both sides



5.25

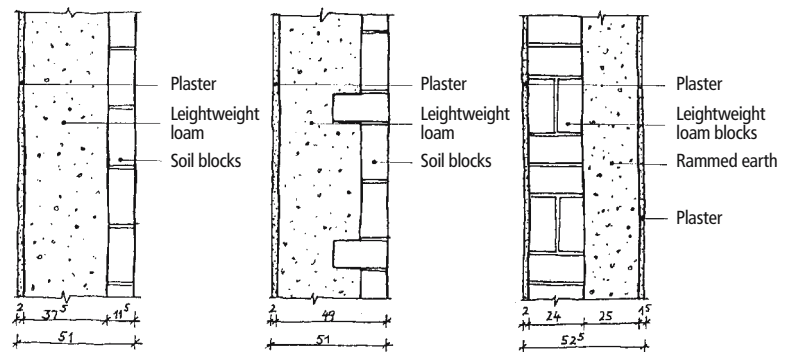

5.29



5.28



5.27



5.26

Rammed earth domes

Probably the first rammed earth dome was built by the BRL in Kassel, Germany, in 1983 using a special technique developed by that laboratory. This consists of a rotating slip form in which the earth is rammed (5.31, 5.32, 5.33).

The thickness of the dome was 18 cm at the bottom and 12 cm at the top. The walls, which form a hexagon on the inside, were also made of rammed earth. In order to transfer the thrust from the dome to the foundation, buttresses were integrated with the walls. The shaping of the top of the buttresses as well as the windows was done with a kitchen knife soon after the form-

work was dismantled. The formwork of the wall was custom-designed according to the plan of the dome, as seen in 5.31. The earth was rammed into the formwork using a vibrator, described on p. 55 in this chapter (see 5.12), and by hand.

The dome formwork itself was so designed that it could be lifted not just at the centre, course after course; it also had a guide that automatically adjusted the radius and inclination of the formwork (5.33).

Drying

It is seldom possible to say when a loam wall is dry, but the drying process is in any case faster than those of masonry or concrete walls (see chapter 2, p. 28). Given dry warm weather and sufficient air movement, shrinkage stops after just a few days. After three weeks, the wall feels completely dry, although water content is still slightly higher than the equilibrium moisture content.

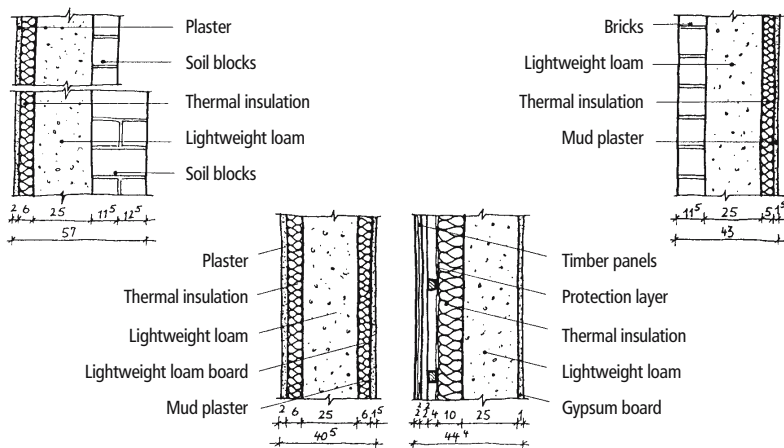

5.30

Labour input

The labour input in traditional rammed earth walls constructed manually, including preparation, transportation and construction, is from 20 to 30 h/m³. By refining the formwork system and using the electrical vibrator described on p. 55 of this chapter (see 5.12), labour input is reduced to 10 h/m³. With the highly mechanised techniques explained above (see p. 56), in which transportation and filling is done by a dumper and compacted by heavy pneumatic rams, labour input can be reduced to as little as 2 h/m³, which is only 10% of the labour used with traditional techniques, and significantly less than that needed for masonry work.

Thermal insulation

The thermal insulation capacities of solid rammed earth walls using normal soil is not sufficient to provide the levels of thermal insulation required in cold climates. The U-value of a 30-cm-thick rammed earth wall is as much as 1.9 to 2.0 W/m²K. To achieve a U-value of 0.5 W/m²K, necessary in many European countries, a thickness of 1.6 to 1.8 m would be required. In cold climates, therefore, either a thick wall of lightweight loam or additional conventional thermal insulation should be used. Some potential methods for making loam walls with improved thermal insulations are described in chapter 14, p. 108.

Surface treatment

A rammed earth wall requires less labour and material inputs for surface treatment compared to walls made using other earth construction techniques. As a rule, it is neither necessary nor advisable to plaster a rammed earth wall. If the surface is sponged with a moist felt trowel immediately after dismantling the formwork, then a smooth surface is easily produced, one that may be painted or wallpapered



5.32



5.33

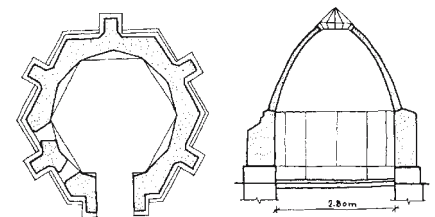

5.31

5.31 Rammed earth test structure, University of Kassel
5.32 to 5.33 Constructing the rammed earth dome with a rotating formwork

(in cases involving interior wall surfaces). If exterior surfaces thus treated are sheltered from rain by roof overhangs and against splashing by a plinth, a coating of paint is sufficient to protect them against the elements. Care should be taken that coatings neither peel nor crack.

6 Working with earthen blocks



6.2

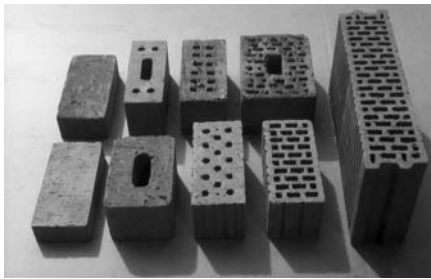

6.1

6.1 Industrially produced green bricks, Germany
6.2 Ancient core of the city of Shibam, Yemen

Blocks of earth produced manually by throwing wet earth into a formwork are called “adobes” or “mud bricks” or “sun-dried earth blocks.” When moist earth is compacted in a manual or powered press, the compressed elements so formed are called “soil blocks.” In their unbaked state, bricks produced by an extruder in a brick plant are called “green bricks.” These three types of blocks are usually the same size as baked bricks. Larger blocks, compacted in a formwork by ramming, are called “rammed earth blocks.”

Some countries have standardised measurements for these blocks. The two sizes used most commonly in Germany, for example, are:

NF (normal format) = 71 x 115 x 240 mm

ZDF (double thin format) = 113 x 115 x 240 mm.

Illustration 6.1 shows different shapes and sizes of green bricks produced industrially by an extrusion process common in the German market. Specific applications of these different types of blocks in walls, floors, vaults and domes are described in chapter 14.

History

Building with earthen blocks is widespread in all hot-dry, subtropical and moderate climates. Earth block buildings dating from 8000 to 6000 BC have been found in Turkestan (Pumpelly, 1908), and ones from ca. 4000 BC in Assyria. Visible even today in Upper Egypt are monumental structures about 3200 years old, such as the huge earth block fortification wall of Medinet Habu and the vaults of the storage rooms in the temple area of Ramses II near Gournah (1.1).

The technique of making vaults and domes from earth blocks without supports during construction (centring or shuttering) was known to many cultures (see chapter 14, p. 117). For centuries, Pueblo Indians in Taos, New Mexico, built their houses using the earth from the sites themselves, the water from nearby streams, and straw from the fields (6.3).

The historical core of the city of Shibam, Yemen, covering about 20,000 m² and accessible only through a single gateway, was built entirely in adobe. Many houses

resemble skyscrapers, and date from the 15th century (6.2).

In Scandinavia and in England, building with sod was common in the 17th and 18th centuries. These houses were constructed of blocks cut from the top layer of loamy soil together with the grass growing on it. The blocks were inverted and used as bricks to form walls without mortar. European immigrants brought this technique to the USA, where a large number of sod houses were built in the 18th and 19th centuries (6.4). Some settlers also adapted the same idea from North American Indian nations such as the Omaha and Pawnee, who for centuries had used the method to cover their round huts with sod (Houben, Guillaud, 1984).

In New Mexico, silty soil blocks cut from riverbeds, and containing a network of roots which act as reinforcement, were used for building walls. These blocks are called *terronis* or *terrones*, and were sometimes used in Mexico and Central America as well. It is interesting to note that building codes in New Mexico still permit building with *terronis*.

In Germany, earth block work was used in the 6th century BC; adobe blocks 40 x 40 cm and 6 to 8 cm high were used in the fort of Heuneburg near Lake Constance (Dehn, 1957). Around 140,000 blocks and 400 m³ of mortar were used to construct its 3-m-high walls (Güntzel, 1986, p. 23). An official circular introducing the use of adobes in walls was published in



6.4



6.3

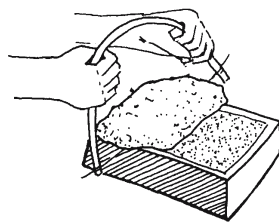

6.6

1764 (Güntzel, 1986, p. 23). David Gilly published manuals on adobe construction in 1787 and 1790.

Production of earth blocks

Adobes are made either by filling moulds with a pasty loam mixture or by throwing moist lumps of earth into them. Different types of moulds can be used; some of these are shown in 6.5. They are usually made from timber. The throwing technique is commonly used in all developing countries (6.7, 6.8 and 6.9). Here, a sandy loam is mixed with water, and cut straw is usually added and the whole formed into a paste that is thrown into wooden moulds. The greater the force with which the loam is thrown, the better its compaction and dry strength. The surface is smoothed either by hand or by a timber piece, trowel or wire (6.6).

One person can produce about 300 blocks per day (including preparation of mix, trans-

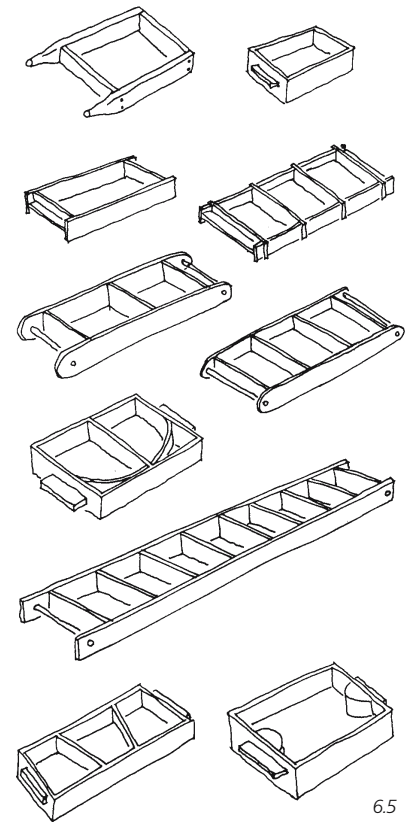

6.5

6.3 Traditional earth dwellings of the Pueblo Indians, Taos, New Mexico, USA

6.4 Sod house, USA

6.5 Moulds for adobes

6.6 Removal of surplus loam with a wire

6.7 to 6.9 Making adobes in Ecuador
 6.10 Making adobes on a work table
 6.11 Metal mould with handles
 6.12 CINVA Ram, Columbia



6.10

manually operated presses have been devised. The best-known press worldwide is the CINVA Ram, developed in Colombia by the Chilean engineer Ramirez (6.12). Illustration 6.13 shows the CETA Ram in operation. It is similar to the CINVA Ram, and was developed in Paraguay. It permits simultaneous production of three blocks. Manually operated presses of this type produce pressures up to 5 to 25 kg/cm², and require three to five persons for optimum operation. Despite mechanised production of soil blocks using presses, the output per person per day is only 150 to 200 blocks, considerably less than that of the primitive method involving throwing loam into moulds.

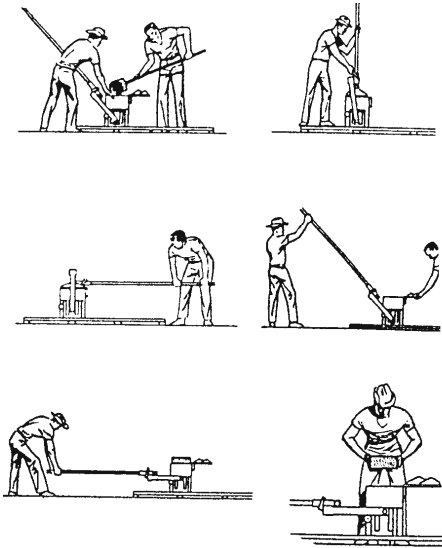

6.11



6.7



6.8

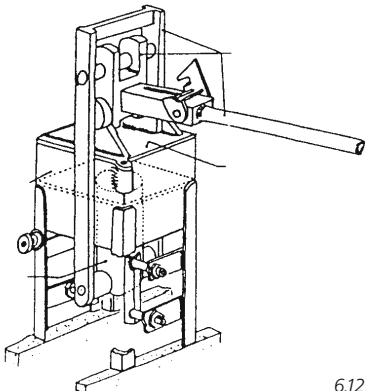

6.12

portation and stacking). In India, one person can produce as many as 500 blocks per day using a double mould designed for a smaller brick. In order to facilitate work, bricks can be moulded on a table, as was traditionally the case in Germany (6.10). Another easy method uses moulds with handles 80 cm in length, which enables workers to manufacture bricks while standing (6.11). Techniques for producing compressed soil blocks were known in Europe in the 18th century. In 1789, the French architect François Cointreaux developed a manually operated soil block press. Since then, numerous



6.9

The advantage of these mechanised presses, however, is that loams with lower water contents can be used. This makes it possible to stack blocks immediately after production.

The disadvantage is that the blocks are usually stabilised with a 4% to 8% cement content in order to endow them with sufficient strength. This is necessary because of the absence of either sufficient water or adequate dynamic impact capable of significantly activating the binding forces of the clay minerals. Without cement, pressed blocks usually have dry a compressive strength lower than that of handmade adobes (see p. 44).

Another disadvantage of such presses is that the soil mix must be kept at a constant level of moisture and composition. If compositions vary, then both the volume of the



6.13



6.15

material to be filled and the pressure changes. This leads to variations in the heights and strengths of the blocks. Fully automatic block-making presses such as those shown in 6.14 and 6.15 can produce 1500 to 4000 blocks daily. However, they require large investments and may be difficult to maintain, especially in developing countries. To assure even loam consistencies, such machines often require separate crushers and mixers. Fully automatic presses are only economical if they have long lives, are utilised extensively on a daily basis, and if raw material of



6.14

even consistency is available locally and in sufficient quantities. Otherwise, capital, maintenance and repair costs quickly diminish any potential economic advantages. In low-wage countries, manual adobe production is usually more economical, as is the production of green bricks in brick plants in industrialised countries. In industrialised countries, brick production using such machines would be economical only if transportation costs were high. (For more information about pressed soil blocks, see Mukerji, 1986; Smith and Webb, 1987; Mukerji, 1988; and CRATerre, 1991).

The production method developed in the USA by Hans Stumpf and patented in 1946, and consisting of a block making apparatus, seems comparatively more efficient (6.16 and 6.17). With this method, loam is prepared to a pasty consistency in a forced mixer and then poured into a large funnel that moves over a grid of moulds. The moulds are filled, and the top and the blocks are then smoothed mechanically. A lever lifts this grid, leaving the separated blocks to dry on the ground. After a preliminary drying period, the blocks can be turned on their edges for even drying. In mechanised brick plants, crushed soil is mixed and pushed by rollers into an extruder, where it is again mixed and pressed through a vacuum-operated mouthpiece into long profiles, which are then sliced by a wire. Drying is accomplished in ovens using commercial energy. Since this entire process is computerised in industrialised brick plants, it may be difficult to order green bricks, and

6.13 CETA Ram, Paraguay

6.14 Automatic block press CLU 3000, Switzerland

6.15 Automatic block press (Pacific Adobe, USA)

6.16 to 6.17 Adobe production technique developed by Hans Stumpf, USA

6.18 Green bricks drying in the air at brick plant, Gilserberg, Germany

6.19 Shrinkage cracks that occurred after rain-drenched green bricks dried out

6.20 Cutting earth blocks



6.18

pressive strength with minimum shrinkage. But at the same time, there must be enough clay to create sufficient binding force for the block to be handled.

Laying earth blocks

It is important to shelter earth blocks from rain on site. In industrialised countries, as a rule, green bricks ordered from factories, are palletised and covered entirely in plastic. Earth blocks are laid with either loam mortar, hydraulic lime mortar or high-hydraulic lime mortar. While small quantities of cement may be added to these mortars, pure cement mortar is not advisable, as it is too rigid and brittle. To avoid shrinkage cracks inside the mortar during drying, the mortar should contain sufficient quantities of coarse sand. The clay content may vary from 4% to 10%. The formation of shrinkage cracks can also be avoided when the mortar layer is thinner than usual. It is a pleasure to work with loam mortar, since it is not abrasive to the skin. Lime mortar, however, attacks the skin and may also cause allergies.



6.16

the prices quoted are sometimes more than those for ordinary fired bricks. With simpler production processes and open-air drying, on the other hand, it was possible in at least one German case, to obtain green bricks that are 40 % cheaper than the price of regular fired bricks.



6.17

Material composition

The loam used in common brick plants requires high clay content in order to achieve sufficient strength after firing. Illustration 6.21 shows a typical soil grain size distribution of this type of loam, containing 24% clay, 50% silt, 23% sand and 3% gravel. When loam of this composition is used for earth block work, it creates swelling and shrinking problems upon wetting and drying respectively. Illustration 6.19 shows cracks occurring when these green bricks were used in a project where a wall was drenched by sudden rain during construction.

The soil grain size distribution of a leaner sandy loam appropriate for earth blocks is shown in 6.22. It shows 14% clay, 22% silt, 62% sand and 2% gravel, and shows no shrinkage cracks after drying.

Generally, it can be stated that earth blocks should have enough coarse sand to allow them to achieve high porosity (and therefore high frost resistance), and high com-

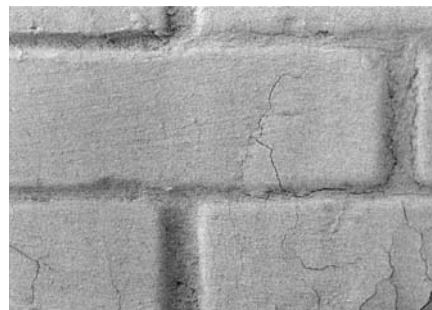

6.19



6.20

6.21

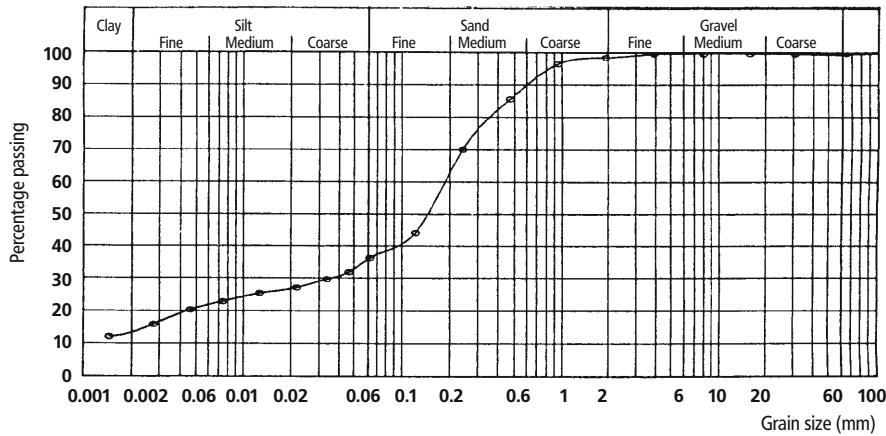

6.22

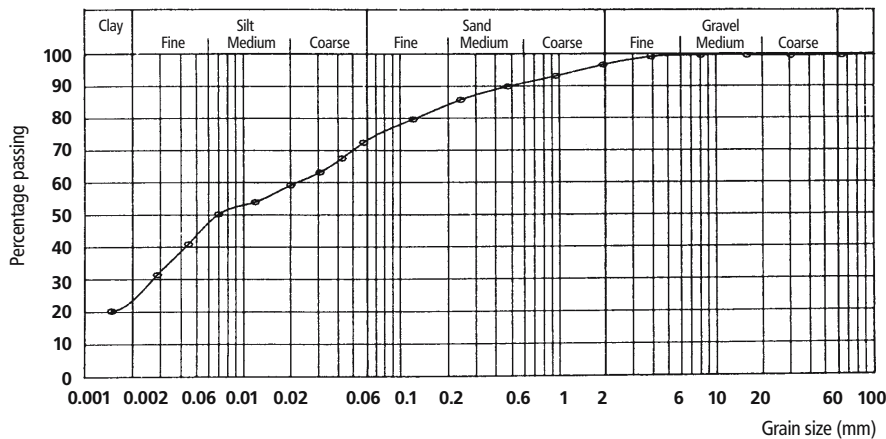

6.21 Grain size distribution curve of loam used in a brick plant

6.22 Optimised grain size distribution curve for adobes

6.23 Exposed earth block wall finished with a loam-lime slurry, Bendigo, Australia

6.24 Bookshelves fixed to an earth block wall

6.25 Industrially produced unburned lightweight bricks

If the blocks are dipped in water for a short time to make the surface soft and pliable, it becomes possible to build walls from earth blocks without using mortar. These soaked blocks can be simply stacked, as with any dry masonry work, and they will bind. Such work, however, requires a very fine eye and skilled workmanship, for it is difficult to control the horizontal joints and the pattern, since no tolerance of mortar thickness is available.

Earth blocks can be cut much more easily than baked bricks, using ordinary saws, for example, as seen in 6.20. If parts of blocks are required, they can either be sawed right through, or else cut to depths of about 2 cm, after which sections can be broken off with the tap of a hammer. In place of a saw, a groove can also be scored with a trowel or a knife before using the hammer.

Surface treatment

If sufficiently moistened with a tool like a felt trowel, exposed earth block masonry with uneven surfaces or joints can be easily smoothed. Plastering is not advisable, since it interferes with the capacity of loam walls to balance internal air humidity (see chapter 1, p. 16). However, exposed earth block masonry can, if not aesthetically acceptable, be given a wash of loam slurry stabilised with, for example, lime, lime-casein etc. (6.23). This wash also impacts the wall's surface stability (for more details about surface treatment, see chapter 12, p. 98).



6.23

Lightweight loam blocks

So-called lightweight loam blocks or green bricks have a specific weight of less than 1200 kg/m^3 and consist of clayey soil with light aggregates such as straw, saw dust, cellulose fibres, cork, perlite, pumice or expanded clay. Due to their good thermal insulation effects, they are used for exterior walls in cool or cold climates. Illustration 6.25 shows some of these unburned bricks that are produced industrially in Germany.

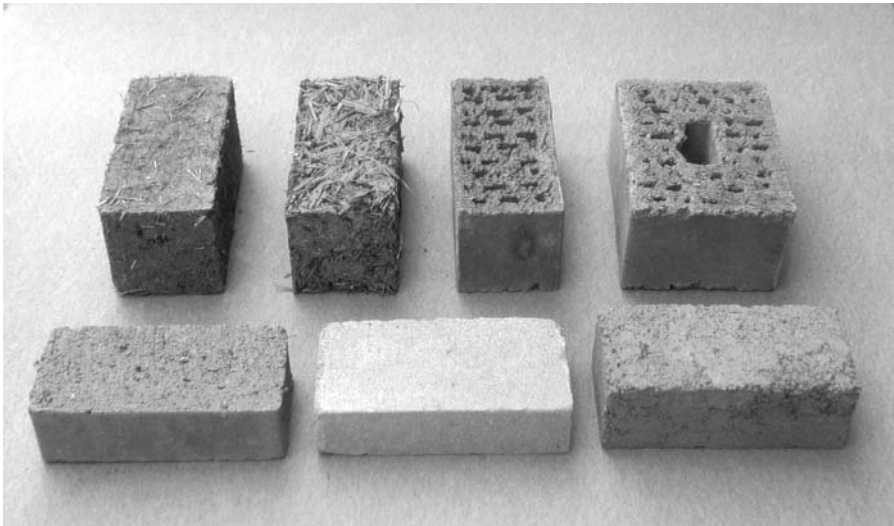

6.25

Fixing fasteners to walls

Nails can be driven into an earth block walls more easily than into those constructed of baked bricks. The more porous and humid the material, the easier one can drive a nail through it. Green bricks tend to split more easily than soil blocks and adobes. If very thick nails are used, it is advisable to drill a hole into the block. Heavy shelves or wall-hung cabinets can be fixed to the wall easily using screws and dowels. Dowel holes, however, should be drilled large enough to prevent blocks from cracking. In 6.24, heavy bookshelves are fixed to a green brick wall using dowels and screws.



6.24

Special acoustic green bricks

In order to optimise the acoustic behaviour of domed rooms, a special loam brick with rounded corners was developed by the author (6.27). The rounded corners and the corbelling effect of the bricks (6.26) yield good sound distribution, while good sound absorption is produced by the cut-off joints and the holes in the brick. Illustration 6.28 depicts a 6-m-high wall of unburned (green) bricks, introduced in order to improve the acoustic behaviour of the hall.

6.28

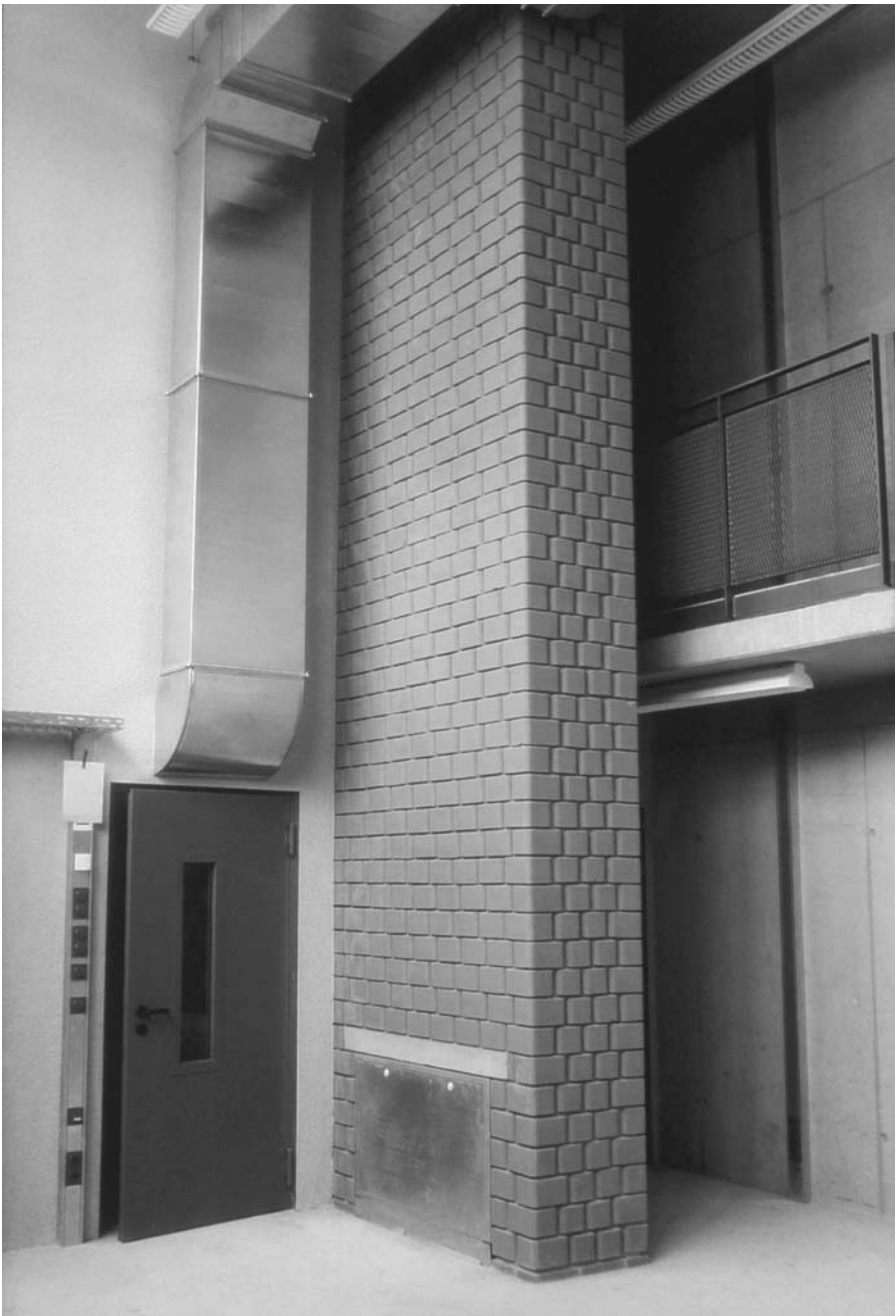

6.26



6.27

6.26 Detail of loam
brick dome

6.27 Special loam brick
to improve acoustic
behaviour

6.28 Loam brick wall

7 Large blocks and prefabricated panels



7.1 Making lightweight straw loam blocks

7.2 Exterior wall made of large blocks of lightweight straw loam

With monolithic rammed earth walls, or even with small-sized brick masonry, manpower is high and drying time can delay construction work due to the inherent water. Therefore, several ideas involving larger prefabricated elements have been developed.

Large blocks

Provided they are light enough to be carried in one hand, or at most in both, larger blocks can be laid faster. Lightweight aggregates and cavities can be used to reduce weight. For easy handling, grip holds should be incorporated in block shapes.

Lightweight straw blocks, 50 x 60 x 30 cm, used in several projects by the German architect Sylvester Duffer, are more efficient for making walls. Though each block weighs 26 kg, they are produced under cover and close to the wall, and can then be almost

flipped over into their final positions (see 7.1 and 7.2). Using such blocks, a 50-cm-thick wall gives a U-value of 0.3 W/m²K. Duffer guided several do-it-yourself projects using these blocks. In one case, the owner-builder family produced 1500 blocks in five weeks, sufficient for their entire house.

Lightweight mineral loam blocks measuring 15 x 15 x 30 cm, which are made of loam and expanded clay, have been produced in Hungary utilising egg layers (of the type used in making concrete blocks) (7.3). Such blocks were used to provide additional external thermal insulation to a rammed earth wall house in Tata, Hungary (7.4). Different sections for larger wall panels made of lightweight mineral loam, and developed by the author of this book, are shown in 7.5. These can be used either in



7.2

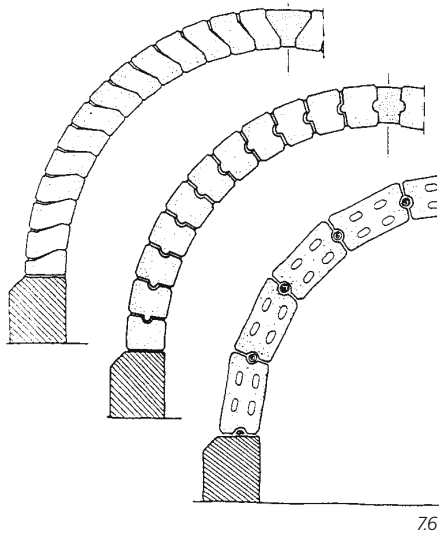

76

internal walls, or to increase the thermal insulation of exterior walls from the outside. Cavities reduce weight and increase thermal insulation, while simultaneously providing grip holds for easy handling. Illustration 76 shows similar elements that can be used for making vaults.

Prefabricated wall panels

Prefabricated elements, each 6 to 12 cm thick and measuring between 30 x 60 cm and 62.5 x 100 cm, have been used for non-load bearing elements. These should be made of lightweight loam with the density 800 to 1,000 kg/m³. Panels lighter than 800 kg/m³ must be edged with timber, since their edge strengths are insufficient for handling. An extremely light element with a density of 550 kg/m³ was developed by the German firm Breidenbach; it is made of reed mats plastered with loam and covered with a jute fabric.

Illustration 77 shows a wall built with "Karphosit" elements, which are produced from clay powder and straw cuttings, and have a density of 850 kg/m³. They measure 62.5 x 25 x 10 cm. The German firm HDB Weissinger produces 1-m-wide and up to 3-m-high timberframe wall elements filled with lightweight loam (78 and 79).

Floor slabs

Loam elements which act as infill between floor joints also provide sound and thermal insulation (710). In Hungary in 1987, the author of this book developed load-bearing infill elements with cement-stabilised lightweight loam. Illustration 711 shows such an element along with its mould. Illustration 712 depicts various designs for load-bearing floor panels.

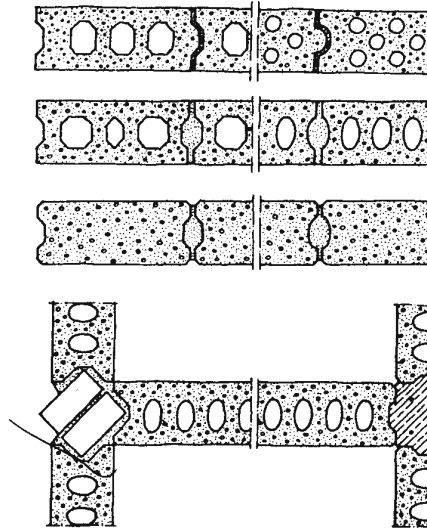

75



77



73

73 Making lightweight mineral loam blocks, Tata, Hungary



74

74 Using lightweight mineral loam blocks as external additional thermal insulation for a rammed earth wall, Tata, Hungary

75 Lightweight loam blocks for wall construction

76 Lightweight loam blocks for vaults

77 Interior wall from lightweight loam panels

Floor tiles

Prefabricated tiles made with stabilised earth can be used for flooring. One advantage is that since they are already dry, shrinkage only occurs in joints. Miller, Grigutsch and Schulze (1947, p. 5) recommend the use of Fe_3O_4 , oxblood and tar in order to stabilise these tiles and provide them with surface hardness. Tests at the Building Research Laboratory (BRL) showed that a high degree of surface hardness could be obtained by adding 6% double-boiled linseed oil in conjunction with compacting the surface and using floor wax as a polish. Methods of increasing surface hardness are described in chapter 14, p. 112.



7.9

Extruded loam slabs

Illustration 7.13 shows extruded green loam slabs consisting of a loam with high clay content. They are extruded 3 to 10 cm thick, 50 cm wide and cut into lengths of up to 100 cm or more. -

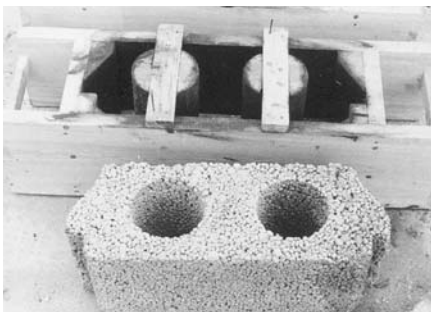

7.11

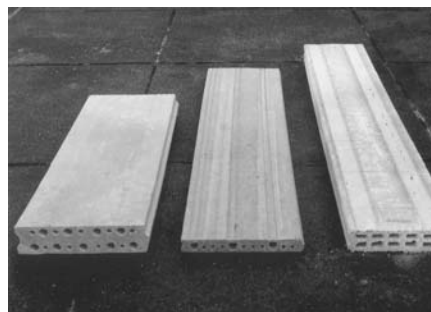

7.13



7.8

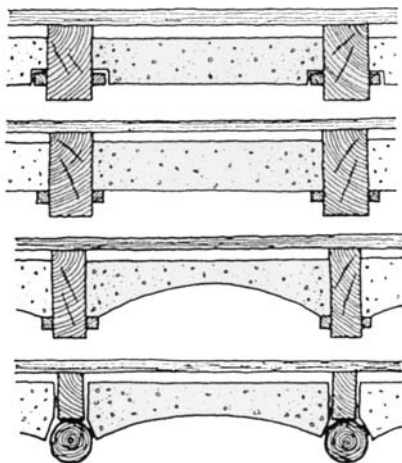

7.10

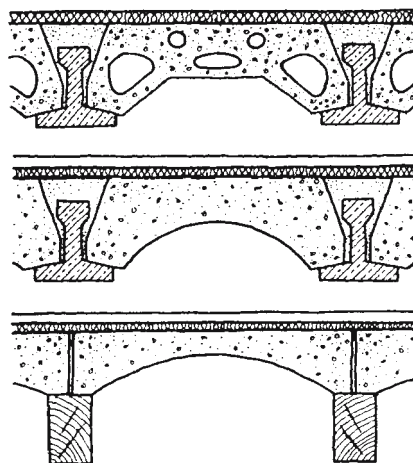

7.12

7.8 to 7.9 Structural elements filled with light-weight loam

7.10 Infill loam elements for floors

7.11 Load-bearing cement-stabilised light-weight loam infills, Hungary

7.12 Load-bearing loam floor slabs

7.13 Extruded loam slabs, Germany

8 Direct forming with wet loam



8.2



8.1

8.1 Forming a bench from wet loam

8.2 Shrinkage cracks in the same bench after drying

8.3 to 8.4 Making walls using balls of wet earth, northeast Ghana (after Schreck-enbach, no date)

8.5 Nankansi courtyard house, north Ghana

Unlike other building materials, wet loam has the capacity to be formed into any shape. It therefore presents a creative challenge to designers and builders. The manual shaping of walls from lumps of wet loam or thick loam paste is widespread in Africa and Asia, and is also known in Europe and America. Since no tools are required to work with earth, it is the simplest and most primitive technique. The prepared mixture is used directly (without intermediate products being formed or intermediate processes). Its disadvantage is that even lean loam of only 10% to 15% clay shows linear shrinkage of 3% to 6% when drying. The higher the clay content and the more water employed, the greater the shrinkage. Thick loam paste with high clay content may even have a linear shrinkage ratio of above 10%. Illustrations

8.1 and 8.2 show a bench formed with wet loam elements where shrinkage was not taken into account. The following sections explain how pre-designed shrinkage cracks of smaller dimensions, or the use of curved elements can help to reduce or even avoid such cracks. The theory involving reducing shrinkage by modifying loam composition is explained in chapter 4, p. 39.

Traditional wet loam techniques

While in the case of earth block work, dry elements are built up with mortar joints, no mortar is used with wet loam work. Plastic loam is bound simply by ramming, beating, pressing or throwing.

In southern India, a very simple wet loam technique is still in use today: using a hoe, earth is mixed with water to a pasty consistency, carried to the site in metal containers balanced on the worker's head, and poured on the wall being built. It is then spread by hand in layers from 2 to 4 cm thick. As the paste dries fairly quickly in the sun, the wall can be built continuously, layer by layer.

In northeast Ghana, another technique is used. Here, balls of wet earth are formed and then used to construct circular walls simply by stacking and pressing (8.3 and 8.4). After the wall dries, the surface is plastered on both sides and then smoothed and polished using flat stones in a rotary rubbing movement. Illustration 8.5 shows



8.5

8.6 Traditional wet loam construction, northwest Ghana (after Schreckenbach, no date)

8.7 Typical dwelling, northwest Ghana (after Schreckenbach, no date)

a compound built using a similar primitive technique.

In northwest Ghana, 40-cm-thick walls have been constructed with wet loam clods using another traditional technique. Here, they are built up in layers so that each successive layer slightly overlaps the previous one (8.6). The rooms of these houses are more or less rectangular, and have rounded corners (8.7).

In north Yemen, multi-storeyed houses have been built using a wet loam technique called *zabur* (8.8, 8.9 and 8.10). Here, clods of straw loam are shaped by hand and thrown with strong impact to build the wall in such a way that they are compacted and adhere to the base, forming a homogenous mass. The surface is often beaten and compacted by hammering with a kind of wooden trowel.

A technique of building using loam clods called "cob" was widespread in southwest England beginning in the 15th century, and was used at least until the 19th century, especially in Devon. Hill describes this technique as follows: a man stands with a three-pronged pitchfork on the plinth of the wall, while a second man forms clods as large as two fists. The second man then throws the clods to the first one, who catches them on his pitchfork and, walking backwards, throws them onto the wall. Where necessary, he also compacts the wall with his feet. In this way, layers 50 to 60 cm in height are built up. To give an even finish, the surface is sliced. Wall thicknesses are generally 45 to 60 cm (McCann, 1983). Illustration 8.12 shows a house, one still inhabited, at

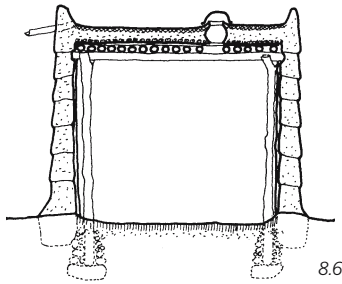

8.6

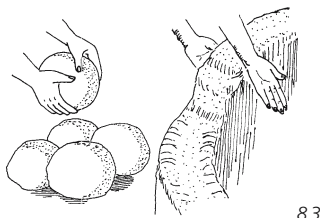

8.3

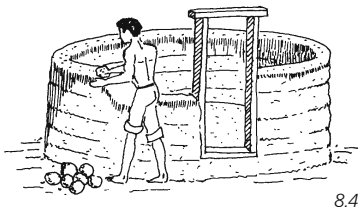

8.4

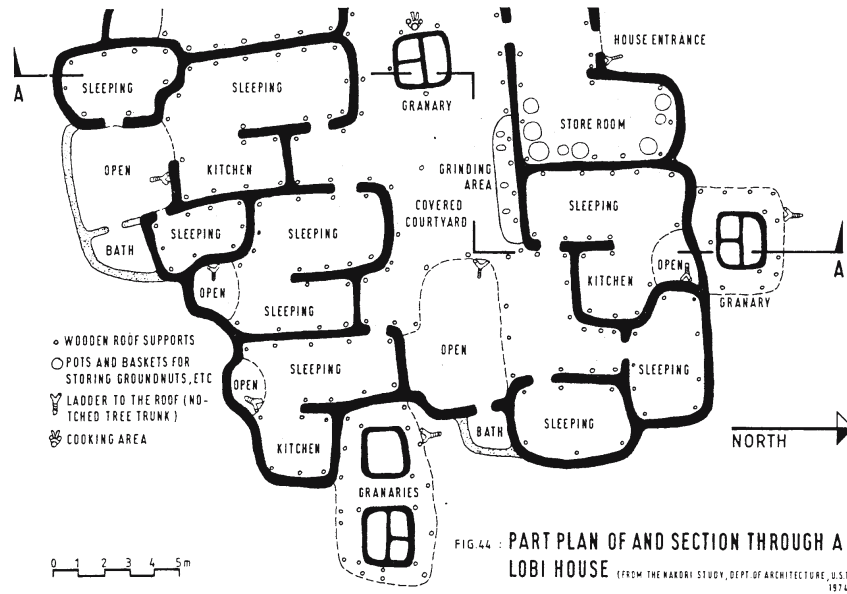

8.7

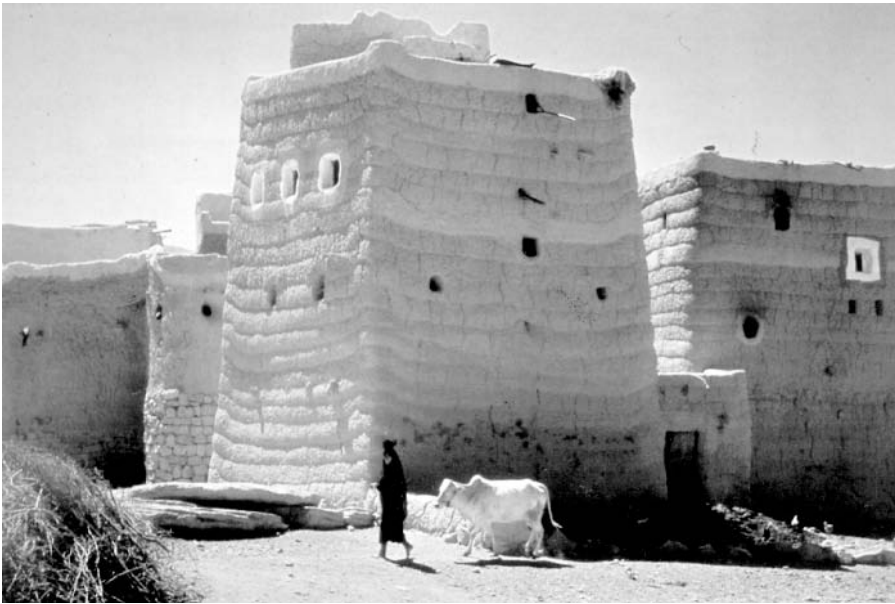

8.8



8.9

Cockington (Devon, England) that was built using this technique in 1410. A similar technique called Wellerbau, has been known in German since medieval times, and was especially widespread in Thuringia and Saxony. Here, the straw loam is not formed into clods as in the cob technique, nor compacted by throwing as with the *zabur* technique, but is directly stacked with a pitchfork and then compacted using feet or rams (8.11). The wall is built up in layers of 80 to 90 cm. After a short drying period, the surface of these layers is smoothed with a wedge-shaped spade.

laid per day. A lime plaster several layers thick is used after the wall is dry. The first such house was built in 1925 (8.14). Within the next five years, more than 300 houses were built by co-operatives, formed by unemployed workers on the initiative of von Bodelschwingh. The entire families of the members participated in production and construction.



8.10

The "Dünne loam loaf" technique

Techniques similar to the ones used in Slovakia and Yemen, described above, were known in North Africa. They inspired Gustav von Bodelschwingh, a German missionary, to adapt them to German conditions. The resulting technique derives its name from the small town of Dünne, where it was first used.

Here, wet loaves of loam are stacked in masonry patterns, but without mortar. In order to provide better bonding to the plaster that is applied later, a conical hole is made on the outer face of each loaf using the finger (see 8.13). Three to five layers are

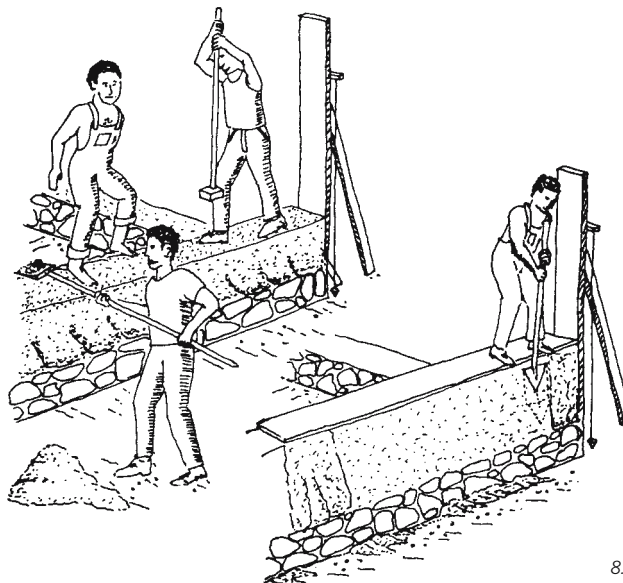

8.11



8.12

8.8 Multi-storeyed houses made using the *zabur* technique, Yemen

8.9 to 8.10 Construction of a loam wall, using the *zabur* technique

8.11 Traditional *Wellerbau* technique, Germany

8.12 Cob building from 1410, Cockington, Devon, England

8.13 Unplastered wall of a sheep shed, Dünne, Germany

8.14 Residence, Dünne, Germany



8.13



8.14

The *stranglehm* technique

At the Building Research Laboratory (BRL) a new wet loam technique, termed the *stranglehm* ("loam strand") technique, was developed in 1982. Walls, vaults and domes can be built with this technique. Even built-in furniture and sanitary items, as described in chapter 14, p. 133, can be formed.

Production of *stranglehm* elements

In order to produce wet loam profiles, an extrusion apparatus was developed by the BRL. Using this machine, wet loam profiles

8 x 16 cm in section can be produced at a rate of 2 m per minute (1.4 m³/h). This prototype, which was arranged vertically, as seen in 8.15, was later refined, yielding an output of 3 m per minute (2 m³/hr) using a horizontal arrangement, as seen in 8.16. The machine consists of a feeder section with two counter-rotating cylinders, which mix the material before conveying it to a section with rotating knives for mixing. The material is then moved into a worm gear, which creates sufficient pressure to force the material out of the extrusion mouthpiece.



8.15

Preparing the mix

Tests with 30 different mixtures, including some containing straw, sawdust and pine needles, showed that shrinkage reduction and increase of output was negligible, indicating that the additional labour and effort involved in introducing these additives was not worthwhile. However, the addition of whey increased output slightly, and gave better water resistance and surface hardness. Casein powder and water can be substituted for whey. The mix for this technique must have higher clay content than that for rammed earth blocks. A clay content of 15% was found advantageous. Loam elements with lower clay contents showed cracks at the corners. The content has to be optimised so that the finished profile is dry enough to be handled, yet wet enough to adhere when being stacked into the wall.

Laying the elements

In the first test building made at the University of Kassel, Germany, in 1982 (8.17 and 8.18), 2-m-long extruded profiles were transported on a board and flicked over onto the wall. The joints were finished by pressing them with bare hands or with a modelling stick. Since the weight of the upper layers cannot be allowed to squeeze out the lower material, only three to five layers are possible in a day. As these profiles showed shrinkage of about 3%, it was necessary to refill the shrinkage cracks that appeared. Since this was laborious, at the next application of this technique in a residential house at Kassel, Germany, in 1984, only 70-cm-long profiles were used. The results showed that at this length, and with pre-designed contraction



8.16

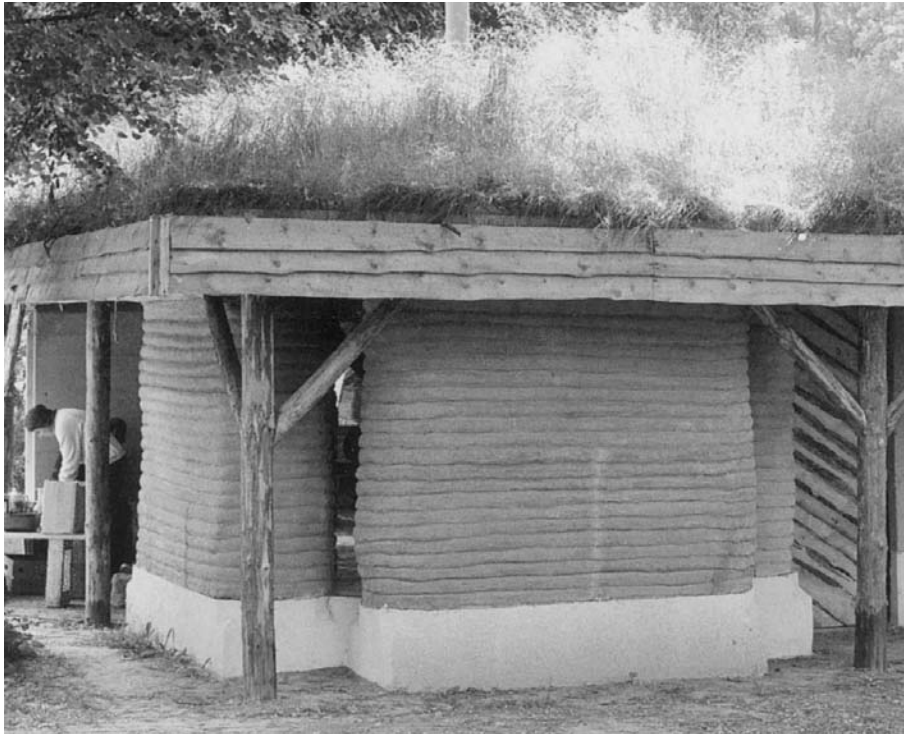

8.18



8.17

joints spaced at 70 cm, no shrinkage occurs in the elements themselves. The extruder was positioned at the centre of the house to minimise transportation distances.

8.15 Vertical extruder for extruded loam profiles (Heuser)

8.16 Horizontal extruder for extruded loam profiles (Heuser)

8.17 to 8.18 Walls of extruded loam profiles, test house, University of Kassel, 1982

8.19 Extrusion of loam profiles

8.20 to 8.22 Stacking extruded loam profiles in a plastic state

8.23 Smoothing the surface with a wet sponge

8.24 Sculptured interior wall made of extruded loam profiles

8.26 Filling a contraction joint with slightly moist loam



8.19



8.23



8.20

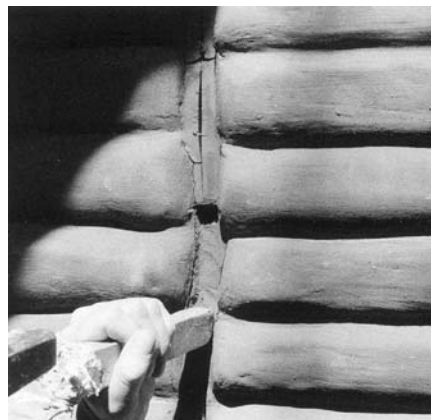

8.24

Illustrations 8.19, 8.20, 8.21 and 8.22 show the production, transport and laying of these elements. The walls of this project are framed in timber with posts at 2.1 m centres. The panel thus formed is divided into

three parts with vertical timber elements 4 x 4 cm in section at 0.7 m/centres. They act as tongues fitting into the loam elements to provide lateral stability. In order to ensure separation of these elements during the drying process a cut is made with a trowel, so that the joints act as pre-designed contraction joints. Upon drying, this gap widens due to shrinkage, and can be favourably filled when dry with a mixture of lime, gypsum, sand and loam. It is very easy to smooth the surface of these elements with a moist sponge (8.23), though to get a richly textured and a regular effect (as seen in the photographs), more shaping by hand may be done before sponging. Illustration 8.24 shows the filling of a contraction joint with slightly moist loam using a hammer and a wooden tool. Illustration 8.26 and 8.27 show finished walls. Walls composed of these elements can be shaped easily in a wet state; a finished example is shown in 8.25, where material has been added to the wall, as well as sculpted out of it.



8.21



8.22



8.24



8.26



8.27

8.26 Finished interior wall made of extruded loam profiles

8.27 Finished *stranglehm* walls, residence, Uchte, Germany (1986)

8.28 Variations of external and internal walls using *stranglehm*

8.29 to 8.30 Making *stranglehm* walls in different patterns

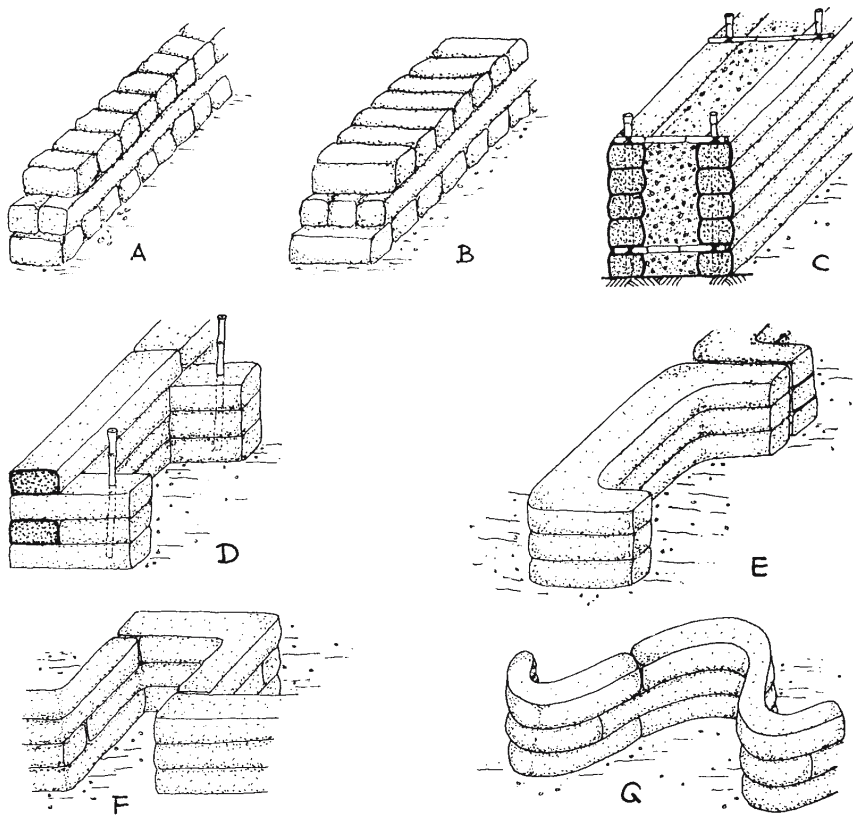

8.28

Wall types

Due to shrinkage of 3% to 5%, long elements are not recommended. Illustration 8.28 shows several possibilities for internal and external walls using shorter elements. Solution C in this figure is only intended for exterior walls. The space between the two extruded loam walls can be filled with light-weight bulk material such as cork particles, expanded clay, pumice etc., to increase thermal insulation. Structural elements can also be positioned in this space. If the other walls illustrated need to be provided with thermal insulation, a common solution is given in 8.31, the U-value of the illustrated wall being $0.295 \text{ W/m}^2\text{K}$.

Illustrations 8.27, 8.29 and 8.30 show work done on a residential house in Germany, with smaller extruded loam profiles obtained from a brick manufacturing plant. Due to the production process, this loam had to have higher clay content, causing a large number of shrinkage problems; repairing the cracks that occurred turned out to be very time-consuming.

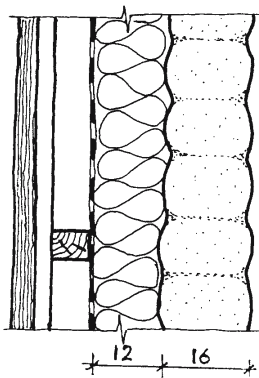

8.31



8.29



8.30

9 Wet loam infill in skeleton structures

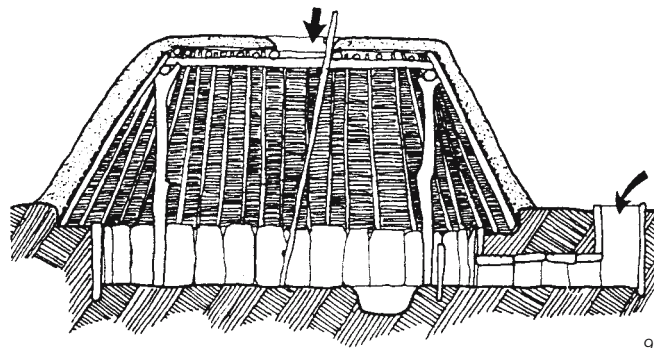

9.1

Plastic loam has been used for thousands of years to fill gaps in log houses where the logs are laid horizontally, as well as in palisades (where the tree trunks are positioned vertically). In traditional European Fachwerk (timber-framed) houses, as well as in American, African and Asian wattle-and-daub structures, wet loam (usually containing cut straw) is thrown on an interwoven mesh of twigs, branches, bamboo sticks and the like (9.7). As shown in this chapter, there exist many variations of this technique. Modern techniques of infill that use mechanical devices to reduce labour input are described in this chapter.

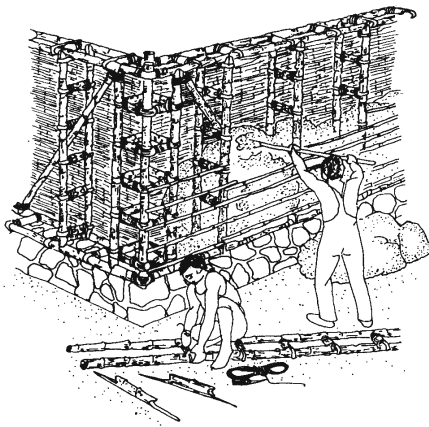

9.2

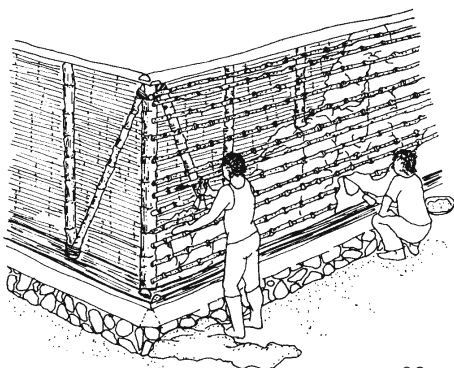

Thrown loam

Thrown loam techniques have been used in all tropical, sub-tropical and moderate climates of the world, and are probably older than rammed earth and earth block practices. These wattle-and-daub techniques are called bahareque, bajareque,

bareque or quinchá in Spanish and lehm-bewurf in German.

Such structures consist of vertical and horizontal members that form a network. European systems usually employ vertical timber members interwoven with twigs (9.4).

Loam, usually mixed with cut straw, and sometimes with fibres, is thrown or pressed onto this network so that it covers at least 2 cm of all the members. If this cover is not thick enough and cracks are not well-repaired, walls quickly deteriorate (9.3).

The consistency of the mortar being used is easily checked by dropping a 10 cm diameter ball from a height of 1 m onto a hard surface. If the diameter of the flattened disc thus formed measures 13 to 14 cm, the consistency is just right.

Illustrations 9.2 and 9.5 show a variation of the wattle-and-daub technique in which the size of the mesh is larger (up to 20 cm apart), and there is an exterior and an interior network. The spaces in the grid thus formed are filled in with clods of loam.

Coarse gravel or even stones are sometimes also used as infill. The type of wall shown in 9.5 is constructed of prefabricated components, and was used in several low-cost housing projects in Bahia, Brazil.

Sprayed loam

Since wattle-and-daub techniques are very labour-intensive, various attempts have been made to use spraying machines to apply



9.5



9.3



9.4



9.6

9.1 Traditional pit house of the Pueblo Indians, 3rd century AD, (Bardou, Arzoumanian, 1978)

9.2 Variations of wattle-and-daub technique (after Vorhauer, 1979)

9.3 Traditional wattle-and-daub building, Venezuela

9.4 Traditional wattle-and-daub technique, Germany

9.5 Prefabricated wattle-and-daub system, Brazil

9.6 Spraying lightweight loam

mixtures. The main problem with all of these techniques has been the common occurrence of shrinkage cracks.

The German architect Hans-Bernd Kraus developed a technique in which a thin loam mixture is sprayed simultaneously together with dry sawdust (from a separate nozzle). Both sprays intermix before hitting the wall. Layers 4 to 6 cm thick are sprayed on wood-wool slabs used as a lost formwork. The wood-wool slabs also provide considerable thermal insulation (9.6). Another sprayable lightweight loam used for enhancing the thermal insulation of walls is described in chapter 11, p. 95.

Rolls and bottles of straw loam

In Germany and France, openings in the frameworks of traditional timber-framed

houses are sometimes filled in with elements formed by rolling straw loam around a wooden batten, as seen in 9.7 and 9.8. This is less labour-intensive than the wattle-and-daub technique, and has the added advantage that hardly any shrinkage cracks occur.

Two main systems are used: either a loam dipped straw rope is wound helically around a batten, or a straw mat pasted with loam is rolled onto a batten. The labour inputs of these techniques is still higher than those using "loam strand" techniques (see chapter 8). A variation of the rolling technique was successfully tested at the Building Research Laboratory (BRL). It used a loam mortar with a high coarse sand content, which was pasted onto a metal or plastic wire mesh (commonly used for reinforcing mortars). The loam was pasted onto the mesh in a thickness of 2 cm, and both were rolled around a bamboo stick to form infill elements (9.9, 9.10 and 9.11). Surprisingly, shrinkage cracks nevertheless occurred with this technique.

Illustration 9.12 depicts the traditional German technique of building with "loam bottles." Here, secondary vertical members are fixed 15 to 20 cm apart within the frame. The "bottles" are made by taking 1.5-litre masses of the mixture and dropping them

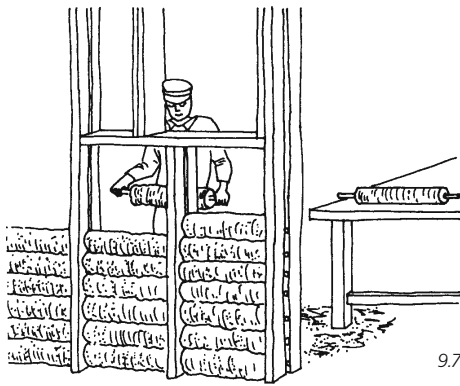

9.7

onto the centre of a cross made of two bundles of straw. The ends of the bundles are then lifted up around the loam, which formed into bottle-like shapes and covered with loam. The bottle is then held horizontally, and the neck wound around the vertical member, while the bottom is pressed against the neck of the previous bottle.



9.9



9.10



9.11

Lightweight loam infill

Since they fail to provide sufficient thermal insulation, the traditional techniques described in earlier sections cannot be used in modern construction in cold climates. To provide thermal insulation, the frames can be filled with lightweight loam mixtures (or the exterior covered with layers of commonly used thermal insulation materials). This technique has the advantage of less labour input and no shrinkage whatsoever. Systems with greater thermal insulating effects are shown in chapter 14, p. 108. The lightweight additives are described in chapter 4, pp. 48 to 51.

9.7 Timber frame wall with infill of straw loam rolls (German: *Wicke!*) (after Houben, Guillaud, 1984)
 9.8 Making loam rolls with straw (after Vorhauer, 1979)
 9.9 to 9.11 Modern method of making straw loam rolls (BRL)
 9.12 Traditional method of making straw loam bottles

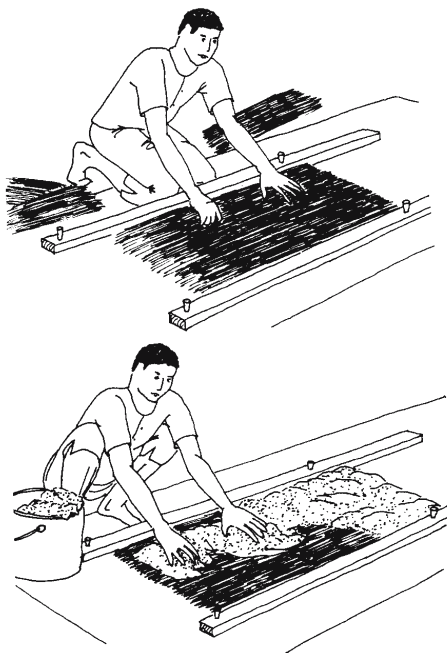

9.8

Infill with *stranglehm* and earth-filled hoses

Modern solutions of filling the openings in timber skeleton structures or timber-framed houses with *stranglehm* or earth-filled hoses are described in chapter 8, p. 75 and chapter 10, p. 89.

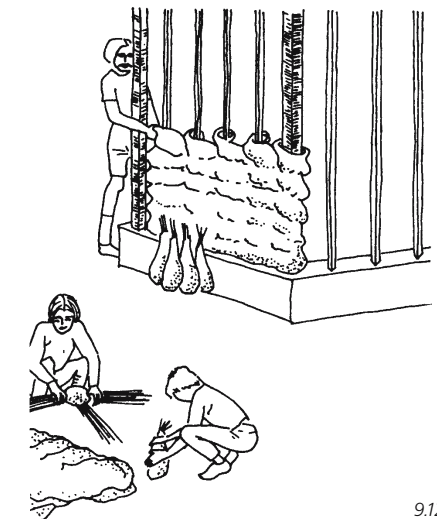

9.12

10 Tamped, poured or pumped lightweight loam

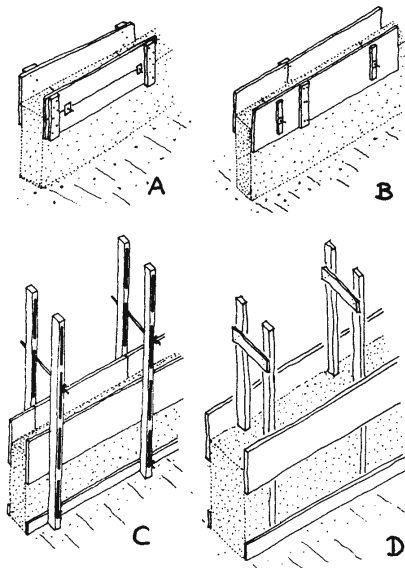

10.2

10.1 Horizontal sections with different inbuilt timber elements
10.2 Systems of climbing formworks

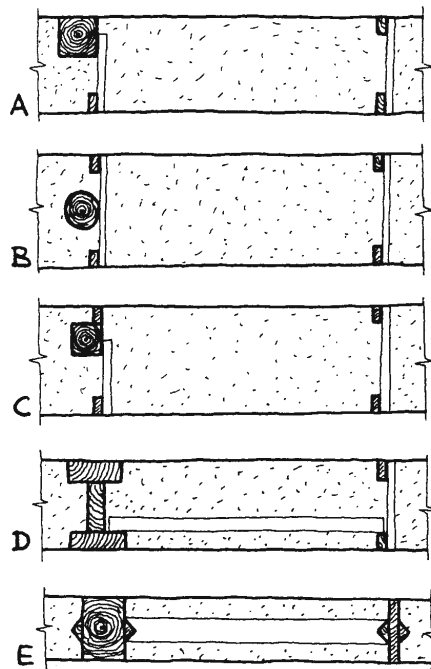

10.1

This chapter introduces several techniques that use lightweight loam by tamping, pouring or pumping for floor, wall or roof systems. The different types of lightweight loams are examined in chapter 4, while chapter 9 discusses how lightweight loam can be used as infill for timber-framed and skeleton structures. Sprayed plasterwork is described in chapter 11. Special designs for walls which give high insulation are discussed in chapter 14, and additional thermal insulation measures using lightweight loam are addressed in chapter 13.

Formwork

Lightweight loam walls can be constructed using any type of formwork, but since less impact is involved than with rammed earthwork, the shuttering boards can be thinner. Various possibilities are shown in horizontal section in 10.1.

In order to reduce the number of boards, climbing formwork is often used. Four types of this system are illustrated in 10.2. When working with lightweight mineral loam, it is even possible to use only a one-sided formwork. This could be done with a board on the outside, in which case the mixture can be thrown onto it from the inside by hand or with a trowel.

Tamped lightweight straw loam walls

The preparation of the mix is described in chapter 4, p. 46. The mixture is thrown into the formwork in layers 10 to 20 cm in height either by hand or (more usually) with a pitchfork, and compacted with lightweight hand tampers.

It should be mentioned that lightweight loam mixtures tend to settle, so that the gaps that form must be inspected and later refilled. The one-metre-high test element shown in 10.3 displayed settling of 9%.

It should also be mentioned that when working with very light mixtures (with densities below 600 kg/m^3) and with walls more



10.3



10.4



10.5

than 25 cm in thickness, the straw might rot in the interior of the wall. Illustration 10.4 shows an example of a 30-cm-thick wall built of lightweight straw loam with a density of 350 kg/m^3 . After some months, when the outside appeared to be completely dry, the core was chased for an electrical installation, and was found to be rotting. Even the structural timber member had been attacked by micro-organisms to depths of 2 cm (Schmitt, 1993). With lightweight walls, wood lice may also appear and eat the straw. Therefore, it is always advisable that the stacks of straw are totally sealed by the loam, which means that the mixture should have a density of more than 600 kg/m^3 .

Tamped lightweight wood loam walls

Wood chips and sawdust are often used as lightweight aggregates instead of straw. These are easier to mix with the loam, but have a lesser degree of thermal insulation effect, and drying takes a very long time. Illustration 10.5 shows the 50-cm-thick wall of a restored historic building whose wood-



10.7



10.6

en members were totally destroyed by fungus because the drying period of the wood loam was more than one year.

Tamped, poured or pumped light-weight mineral loam walls

Lightweight mineral loam can be tamped into formwork like straw loam. But it can also be poured or pumped if the consistency is correct. It also absorbs less water (therefore drying faster), exhibits less fungus growth, greater dry strength, higher vapour diffusion resistance and higher surface hardness than straw loam and wood loam. Various mineral lightweight aggregates are described in chapter 4, p. 49.

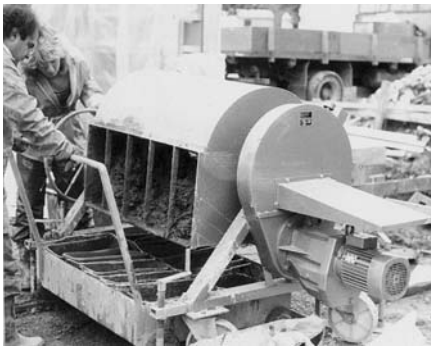

10.8

- 10.3 Settlement of light-weight straw loam
- 10.4 Cut-out from light-weight straw loam wall with rotted interior
- 10.5 Lightweight wood loam wall, destroyed by fungus
- 10.6 Ramming an earth wall of loam and pumice, Pujilli, Ecuador
- 10.7 Shaping a window sill using a machete
- 10.8 Mixing lightweight mineral loam
- 10.9 Pouring lightweight mineral loam



10.9

Tamped walls

Illustration 10.6 shows the construction of a building in Pujili, Ecuador, using pumice as lightweight aggregate mixed in the loam and lightly tamped into a formwork. The formwork was immediately dismantled after the wall was finished. The wall showed a high degree of strength, although it was still possible to cut out window openings and to form sills with a machete, as shown in 10.7.

Poured walls

The easiest way to make a wall of lightweight mineral loam is to simply pour it into a formwork (10.9). In this case, the mix was prepared in a force mixer, shown in 10.8. With this technique, it is even possible to use an ordinary cement concrete mixer in which the loam slurry is poured over the aggregate while it is being turned (10.11). Here, the slurry was prepared with an electrically driven hand mixer, shown in 10.10. The formwork was simply left open on one side for the upper portion of the wall, and the mix was thrown into it and tamped with a flat piece of timber.

In a two-storey house at Tata, Hungary, a load-bearing wall of 50 cm thickness was made with a mixture of loam and expanded clay. The mixture was poured into the formwork through a funnel carried by a crane, a method commonly used in concrete construction (10.12).

A simple method of reducing expenditures is to use a lost formwork made of reed on one or two sides of the wall (10.13).

Illustrations 10.14 to 10.16 show how a lost textile formwork, designed by the author, may be used. A piece of fabric maintains its shape and is stressed by cables fixed to the timber frame. This gives an idea of the unlimited variety of creative surface textures.

Pumped walls

For larger projects, especially if there are firms to make the lightweight mineral loam, it is advisable to pump the mix into the formwork with the use of mortar or concrete pumps. The consistency must be a



10.12

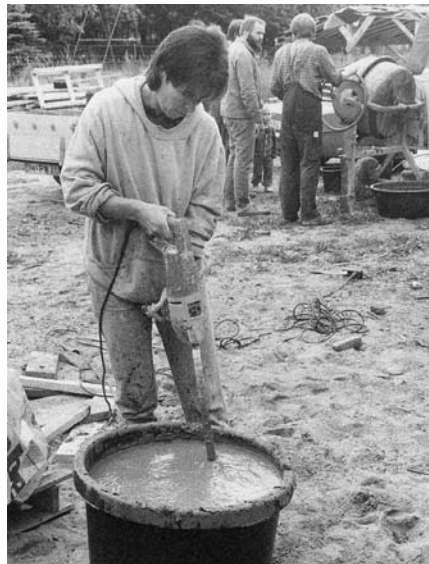

10.10



10.13



10.11

- 10.10 Preparing a loam slurry using an electric hand mixer
- 10.11 Mixing of lightweight mineral loam using an ordinary concrete mixer
- 10.12 Transporting and pouring lightweight mineral loam

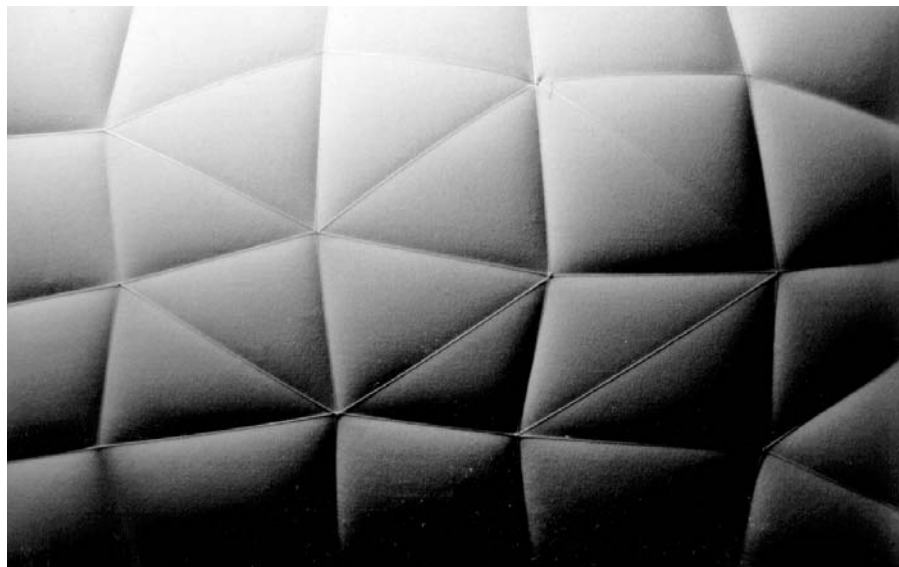

10.14



10.15

10.13 Pouring mineral loam in lost formwork
10.14 to 10.15 Study models for interior walls using lightweight mineral loam and lost formwork of textile stressed by cables
10.16 Vertical section and horizontal section showing the ceiling pattern for a bathroom with a central skylight

little bit thinner than for pouring. It can be pumped up to heights of two storeys using hoses. Illustration 10.17 shows the example of a 300-year-old half-timbered house restored in Germany, where the mix was prepared by a regular mobile concrete mixer, funnelled into a pump, and then piped to the formwork.

Surface treatment

After removing the formwork, the surface of tamped, poured or pumped mineral loam walls with densities of 600 to 900 kg/m³ can be seen to be fairly hard, albeit rough (10.18). This surface need only be plastered with a single thin layer (unlike equivalent

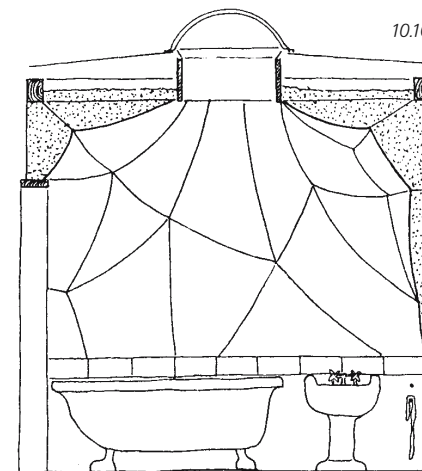

10.16

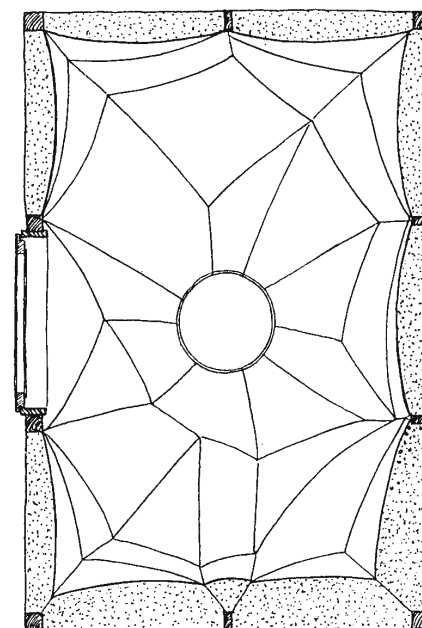



10.17

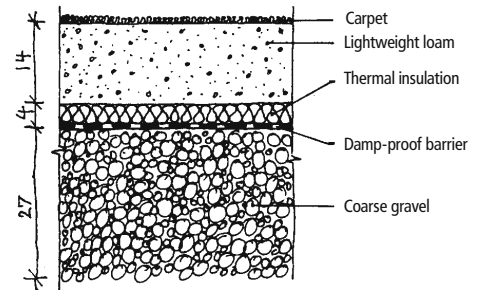

10.20

straw loam walls which require at least two layers). In 10.19, we see a lightweight mineral loam wall with a density of 1000 kg/m^3 being scraped by a rake directly after deshuttering. This forms a nice, roughly textured surface that need only be white-washed later, thus saving plaster.



10.18



10.19

Pumped lightweight mineral loam floors

Lightweight mineral loam pumped in pipes is especially suitable for ground floors and intermediate floor slabs. Illustration 10.20 shows a vertical section of a ground floor with high thermal insulation, which in cold climates offers a warm, comfortable feeling upon entering. Illustration 10.21 illustrates the possibility of using lightweight mineral loam as a cast in situ infill between floor joists. If this mineral loam has a density higher than $1,000 \text{ kg/m}^3$, it serves as a good barrier for airborne noise and gives good thermal storage.

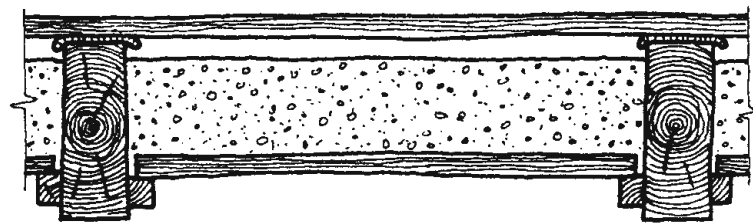

10.21

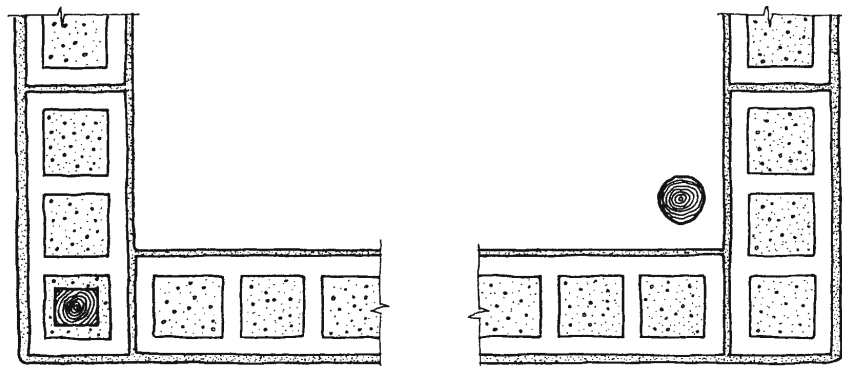

10.22



10.23



10.24

10.17 Transporting and pumping lightweight mineral loam

10.18 Surface of a light loam wall made of clayey loam and expanded clay (8–16 mm) after the formwork was removed

10.19 Scraping lightweight mineral loam wall in order to get a textured surface (without using plaster)

10.20 Vertical section through floor with lightweight mineral loam

10.21 Lightweight mineral loam used as infill in timber flooring

10.22 Loam-filled hollow blocks forming a corner with different positions of structural post

10.23 Filling hoses with lightweight mineral loam using a pump

10.24 to 10.25 Manually filling of hoses with lightweight mineral loam using a funnel



10.25

Loam-filled hollow blocks

In industrialised countries, there are many different types of hollow blocks available, which are usually filled with concrete. They are made of materials such as pumice bound in cement mortar, expanded clay, cement-bound woodwool, lime-bound sand, baked clay or foamed polystyrene. If the wall is not load-bearing, loam can also be used instead of concrete infill loam.

Load-bearing members can be integrated with these walls or placed inside the walls, as shown in 10.22.

If high airborne noise insulation and thermal capacity is required, a high proportion of gravel should be mixed into the loam. If high thermal insulation is required, lightweight aggregates should be added.

Loam-filled hoses

A new technique, developed by the author of this book, was used in 1992 for three residences in Kassel, Germany. Though the outward appearance of walls made by this technique is similar to those made with the technique for making *stranglehm* described in chapter 8, the production, handling and laying is quite different. With this technique, an elastic cotton hose is filled with a lightweight mineral loam mixture. The hose can be filled either using a pump (see 10.23), or by hand through a funnel (see 10.24 and 10.25). When the required length is reached, the hose is cut and the end is stretched and knotted. Owing to the reinforcement provided by the fabric, these loam-filled hoses can

shaped easily without breaking, attractive sculptural patterns can be created (see 10.28 and 10.30).

After laying and some drying, the surface can be easily smoothed with a wet brush. In the wall shown in 10.31, hoses 70 cm in length are laid between vertical posts of 4 x 4 cm turned at 45°, or triangular elements fixed to the main posts of the end of the wall, shown in section in 10.29.

As a rule, three to five layers can be stacked per day, but in order to increase this number some cement can be added to speed up the drying process. Chapter 13, p. 106 explains how these hoses can be used in order to increase the thermal insulation of walls.



10.26



10.27



10.28

then be easily handled. Before being laid onto a wall, they are smoothed with the hands so that some loam oozes and forms a thin loam cover on the fabric. When stacked, these loam coverings stick together (10.26 and 10.27). Since these hoses can be

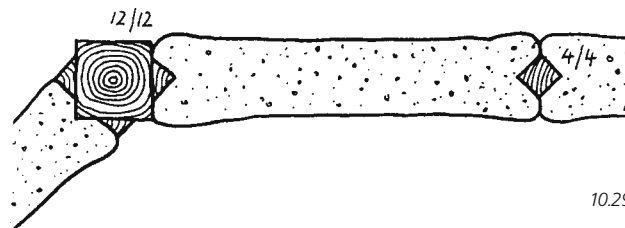

10.29



10.30

10.26 to 10.28 Making a bathroom wall from lightweight loam-filled cotton hoses

10.29 Horizontal section of a wall with loam-filled hoses

10.30 Wall of winter garden made from loam-filled hoses that act as heat storage and for humidity balance

10.31 Interior wall made from loam-filled hoses



10.31

11 Loam plasters

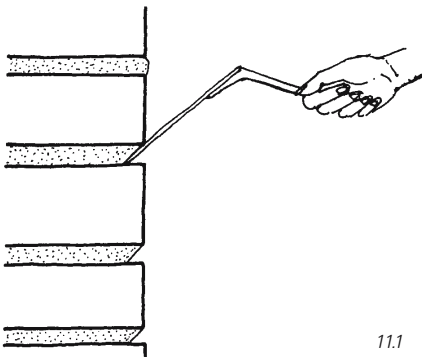

11.1



11.2

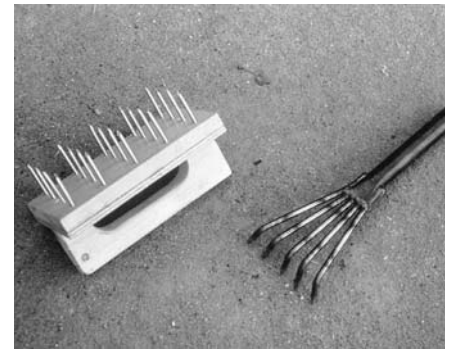

11.3

Loam plasters consist mainly of sand and silt with only as much clay as is necessary (usually between 5% and 12%) for developing their adhesive and binding forces. It is difficult to determine the proportions of an ideal loam plaster, because not only the proportions of clay, silk and sand influence a mixture's properties. Other factors affecting the composition are the grain size distribution of the sand fraction itself, the water content, the type of clay, the method of preparation and the additives. In order to test the appropriateness of loam plasters, samples with varied compositions should be tested. If the surface is rough enough, then loam plasters stick well not only to loam surfaces, but also to those made of brick, concrete and stone. For the ability of loam plasters to balance indoor air humidity see chapter 1.

Preparation of ground

As loam plaster does not react with the ground chemically, the surface has to be

sufficiently rough in order to develop a good physical bond. If masonry is to be plastered, especially when using larger and very smooth bricks, it is recommended that a 45° groove be cut with a trowel into the joints, as shown in 11.1. Another method of obtaining a good bond when rammed loam walls are to be plastered is to wet them sufficiently until surfaces are soft, and to then scratch diagonal patterned grooves into them with a small rake or a nail-trowel (11.2 and 11.3).

In order to ensure that the plaster adheres well, plaster supports can be applied in the form of galvanised wire mesh, plastic mesh, reed mats etc.

Composition of loam plaster

In order to keep loam plaster free of shrinkage cracks, the following points must be kept in mind:

- The loam should contain enough coarse sand.

- Animal or human hair, coconut or sisal fibres, cut straw or hay should be added (however, too much of these additives reduce the ability of the plaster to adhere to the ground).
- For interior plastering, sawdust, cellulose fibres, chaff of cereal or similar particles can also be used as additives.
- In order to develop enough binding force, the adhesive forces of the clay minerals should be sufficiently activated by an adequate amount of water and by movement.
- When the plaster sticks to a sliding metal trowel held vertically, yet is easily flicked away, the correct consistency has been achieved.

11.1 Cutting joints with the use of a trowel

11.2 Scratching a moistened loam surface with a small rake

11.3 Tools for scratching moistened loam surfaces

11.4 Loam mortar test

In order to test the characteristics of a loam plaster, a simple adhesion test can be carried out. The plaster to be tested is applied 2 cm thick to the flat surface of an upright baked brick. The plaster should stick to the brick until it is totally dry, which might take two to four days.

If the plaster falls off in one piece by itself, as seen in the left sample in 11.4, then it is too clayey, and should be thinned with coarse sand. If it falls off in portions after the sample is hammered on the floor, like the second sample in 11.4, then it possesses insufficient binding force, and should be enriched with clay. If the plaster sticks to the

brick but displays shrinkage cracks like the third sample in 11.4, it is too clayey and should be slightly thinned with coarse sand. However, it can be used without thinning as the first layer of a two-layer plaster. If the surface shows no cracks and the plaster does not come off when hammered, as in the fourth sample seen in 11.4 (right), then the sample might be adequate. In this case, it is advisable to make a larger test, about 1 m wide and 2 m high, on the actual wall. If shrinkage cracks now occur, then the mixture needs to be either thinned with coarse sand or mixed with fibres.

Exposed exterior loam plasters

Exposed exterior plasters must either be seasonably weather-resistant, or else must be given perfect weatherproof coating.

In cold climates, it is important that the plasters, together with their coatings, have a low vapour diffusion resistance, so that water condensed in the wall can be easily transported to the exterior. In order to meet thermic and hygric influences without cracking, the exterior plastering must be more elastic than its ground. For cold climates, in general, an external loam plaster is not recommended, unless sufficient roof overhang, plinth protection and good surface coating can be assured.

Since plastered wall edges are very easily damaged, they should either be rounded or lipped with a rigid element. In extreme climates, when the elasticity of large expanses of flat plaster is insufficient to cope with the effects of weather, vertical and horizontal grooves filled with elastic sealants are recommended. Chapter 4 discusses the overall possibilities of reducing shrinkage and enhancing weather resistance and surface hardness.

Interior loam plasters

Interior plasters are less problematic. As a rule, fine shrinkage cracks cause no problems because they can be covered with coats of paint. Dry loam plaster surfaces can be easily smoothed by wetting and worked with a brush or felt trowel.

11.4

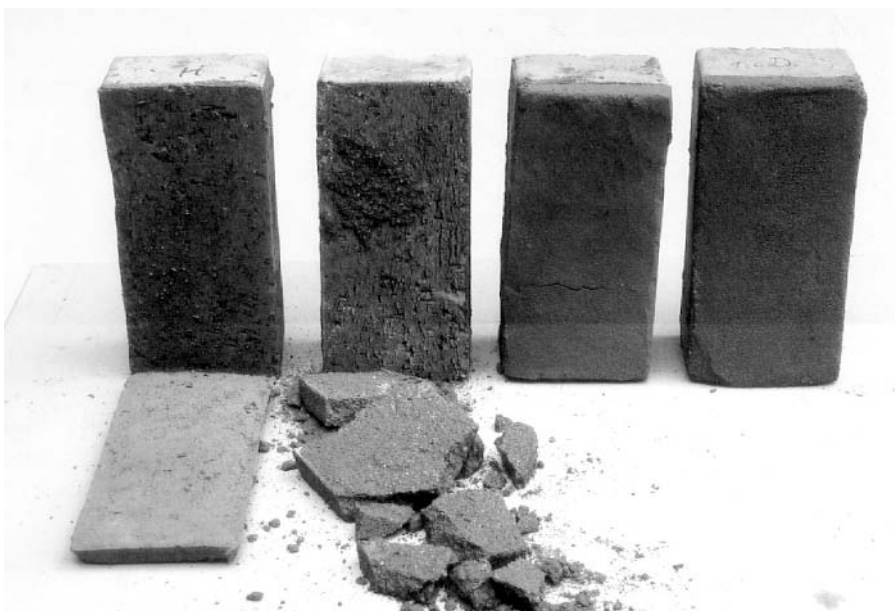

If the surface of the walls demands a plaster thicker than 15 mm, this should be applied in two layers, with the ground layer containing more clay and coarse aggregates than the second one. If the ground layer acquires shrinkage cracks, this is not problematic, and it might even be beneficial by providing a better bond to the final layer of plaster. Adding rye flour improves the workability of the plaster and enhances the resistance of the surface against dry and moist abrasion. Through testing, the author of this book has proven that such resistance can also be built up by adding casein glue made of 1 part hydraulic lime and 4 to 6 parts fat-free white cheese, borax, urea, sodium gluconate and shredded newspaper (which provides cellulose fibre and glue). The following mixes worked well:

Components	Mix ⁽¹⁾				
	A	B	C	D	E
Loam slurry ⁽²⁾	10	10	10	10	10
Sand (0-2)	25	25	25	25	25
Shredded newspaper ⁽³⁾		5	5		5
Casein glue ⁽⁴⁾	1				1
Fat-free cheese				1	
Urea			0.2		
Sodium gluconate		0.2			

⁽¹⁾ all proportions are stated in volumetric terms

⁽²⁾ made of 1 part clayey soil and 2 parts sand

⁽³⁾ treated with borax content

⁽⁴⁾ made of 4 parts fat-free cheese and 1 part hydraulic lime mixed intensively for 2 minutes

Lime reacts with the casein within the fat-free cheese to form a chemical waterproofing agent. A similar reaction is obtained with lime and borax (which is contained in shredded newspaper). Sodium gluconate acts as a plasticiser, so that less water needs to be mixed for preparation (thereby reducing shrinkage). Urea raises compressive and tensile bending strength, especially with silty soils (see chapter 4, p. 43). Shredded wastepaper leads to better workability and reduces shrinkage. The mixes B, C and E exhibited the best workability. When using mixes A and E, it is best to begin by mixing the casein glue and the shredded newspaper together with the water and adding loam and sand after an hour.



11.6

With all mixes, it was found that when the final smoothing was executed using a felt trowel, it was best to wait several hours or even a day.

Guidelines for plastering earth walls

Since pure loam plaster does not react chemically with the ground, it might be necessary to treat the ground so that sufficient curing can occur. In doing so, the following guidelines should be kept in mind:

1. The earth surface to be plastered must be dry enough so that additional shrinkage does not occur.
2. All loose material should be scraped off the surface.
3. The ground should be sufficiently rough and, if necessary, moistened and grooved or the mortar joint chamfered, as described above in this chapter.
4. Before plastering, the ground should be sufficiently moistened so that the surface softens and swells and the plaster permeates the soft layer.
5. The plaster should be thrown with strong impact (slapped on) so that it permeates the outer layers of the ground and achieves a higher binding force due to the impact.
6. If the plaster has to be more than 10 to 15 mm thick, it should be applied in two or even three layers in order to avoid shrinkage cracks.

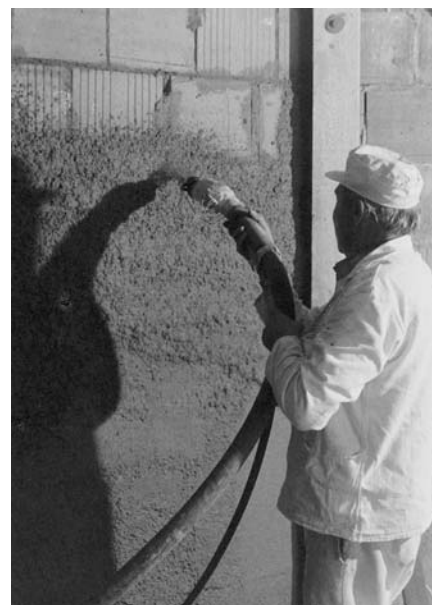

11.5



Sprayed plaster

In 1984, the author of this book successfully developed a sprayable lightweight loam plaster with high thermal insulation, containing shredded newspaper. This plaster can be applied even in a single layer up to 30 mm thick using an ordinary mortar pump (11.5). In order to shorten the curing period, high-hydraulic lime and gypsum were added to the mixture. Other lightweight sprayable plasters used to fill the frames of timber-framed houses and skeleton structures are described in chapter 9, p. 81.

Lightweight mineral loam plaster

Illustration 11.6 shows the surface of an 8-mm-thick loam plaster with expanded clay aggregates 1 to 4 mm in diameter. To reduce curing time and increase vapour diffusion resistance, the plaster was stabilised with 5% high-hydraulic lime. It is not easy to smooth the surface with a trowel, since the aggregate tends to come out during the process. To avoid this, shredded paper, cellulose fibres or casein-glue can be added into the mix.



7. To reduce shrinkage cracks while drying, the mortar should contain sufficient quantities of coarse sand as well as fibres or hair.

8. To improve surface hardness, cow dung, lime, casein or other additives should be added to the top layer (see chapter 4, p. 40 and p. 47).

9. In order to provide surface hardness and resistance against wet abrasion, the surface should be finished with a coat of paint.

10. When using plasters, changes in the physical properties of materials caused by additives and coatings should be kept in mind, especially with respect to vapour diffusion resistance.

Thrown plaster

Illustrations 11.7 and 11.8 show how a traditional African technique, consisting of throwing loam balls onto a wall, has been adapted. Here, this technique is used on a wood-wool board for the wall of a winter garden, described in chapter 14, p. 129. In order to increase adhesion, bamboo dowels were hammered halfway into the board.

Plastered straw bale houses

Straw bale houses, known since the end of the 19th century when the first example was built in Nebraska, USA, found a renaissance in the 1980s. Meanwhile, a lot of new houses with straw bale walls were built in

11.5 Spraying lightweight loam plaster
11.6 Lightweight loam plaster with expanded clay (1–4 mm)
11.7 to 11.8 Thrown plaster in a winter garden



11.9

Australia, France, Scandinavia and other European countries. Most historic walls of this kind were load-bearing. Nowadays mainly timber skeleton structures are used which are filled or surrounded by straw bales. The simplest method for covering such walls is to use loam plaster. To create a good bond and rigidity a chicken wire or plastic net has to be fixed to the bales before plastering. This can be done manually or by spraying with guns. Illustration 11.10 shows the plastering of a straw surface with a spraying gun, 11.11 the gathered texture and 11.12 the interior surface of a straw bale dome, with lamps integrated into the wall. For additional information on such structures, see Minke and Mahlke, 2004.

Wet formed plaster

As loam plaster retains its plastic state for a long time and is not corrosive to the hands like lime or cement plasters, it is an ideal material for moulding with the hands. Illustration 11.9 shows an example of an exterior loam wall stabilised by a lime-casein finish.

Protection of corners

As loam plaster is susceptible to mechanical impact, corners should preferably be covered by wooden profiles, baked bricks or similar lippings (11.13).

11.9 Sculptural earth wall
 11.10 Spraying of earth plaster to straw bale wall
 11.11 Smoothed surface after spraying
 11.12 Plastered straw bale dome with integrated lamps, Forstmehren, Germany
 11.13 Protection of earth wall corners

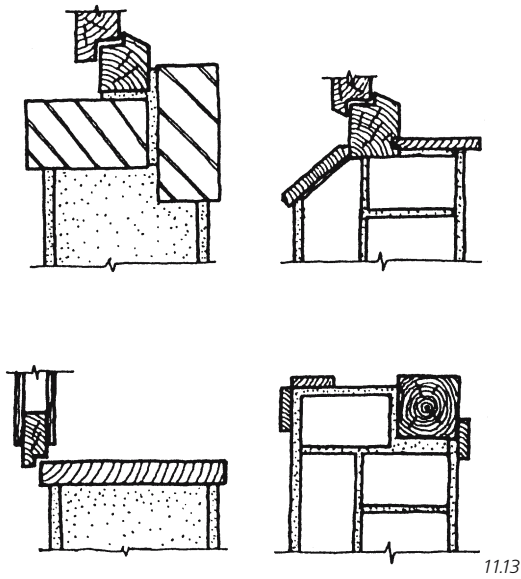

11.13



11.12



11.10



11.11

12 Weather protection of loam surfaces

Loam surfaces need not always have additives in to be made weather-resistant. It is often sufficient to protect or harden them with plaster or paint. This chapter describes the different ways loam surfaces can be made more resistant to environmental forces, and the structural measures required to shelter them from these forces.

Consolidating the surface

The simplest method of hardening the surface, especially against rain and wind erosion, is to consolidate it. This can be done by rubbing a metal trowel with high pressure onto the surface when it is moist and slightly pliable. Traditional Indian and African methods employ flat but light convex stones that are rubbed in a circular motion across the surface with great force. The treatment is adequate if the surface appears shiny and no pores or cracks are visible. While this leaves the composition of the material unaltered, it nonetheless creates a surprisingly high degree of weather resistance.

Paints

Paints on exposed loam surfaces have to be renewed periodically. The paint can be physically eroded by wind, frost or rain, or chemically eroded by ultraviolet radiation or acid rain. External paints should be simultaneously water-repellent and, especially for

cold climates, porous, i.e., should contain a coherent net of micro-pores that allow vapour diffusion to the outside. Latex and dispersion paints, therefore, are not recommended.

For information supplementing that contained in this chapter, see Wehle (1985).

Preparation of ground

If the ground is very silty and lime-based paints are used, the surface should be primed with thin lime-casein milk and then rubbed. The primer can be made of two parts of hydraulic lime, one part fat-free white cheese and 15 parts water.

Recommended paint mixtures

Pure lime wash

The lime wash mixture has to be very thin, allowing the paint to penetrate deeply enough into the ground so that flaking does not occur during drying. Therefore, three or even four thin coats are recommended, with the first coat being the thinnest. The mix can be made from 50 kg hydraulic lime dissolved in 60 litres of water. It is often preferable to add 1 to 2 kg of kitchen salt; being hygroscopic, the salt allows the mixture to remain moist longer, thereby ensuring better curing of the lime. Pure lime wash is perfectly white when dry, but can be toned down by adding clay or loam powders or other lime-proof earthen pigments. Pure lime wash is not wipe-resistant.

Lime-casein wash

Lime washes are much more wipe-resistant and durable if whey, fat-free white cheese (*quark*) or casein powder is added. *Quark* is obtained when rennet from young cows is added to skimmed milk. This cheese contains 11% casein. Lime, together with casein, forms a chemical waterproofing agent called lime albuminate. Today, the use of cheese is the best solution for lime-casein washes. In traditional lime-casein washes, whey or sometimes skimmed milk was used instead of cheese.

Mixtures containing 1 part fat-free cheese, 1 to 3 parts hydraulic lime and 1.5 to 2.5 parts water proved effective. Small amounts of double-boiled linseed oil (not more than 4% of the amount of cheese) increase wipe resistance but reduce the workability of the wash. To get an even emulsion, it has to be well-mixed and stirred from time to time (sometimes every five minutes).

An even stronger and more wipe-resistant paint is obtained by mixing 1 part hydraulic lime with 5 parts fat-free cheese and 5 parts loam.

In bathrooms and kitchens, where greater dry and wet wipe resistance is required, the following procedure is recommended: 1 part hydraulic lime and 5 parts fat-free cheese are mixed without water for about two minutes using an electric mixer. This is allowed to stand for some time, and then 20 parts hydraulic lime, 2% to 4% double-boiled linseed oil and water are added. Two coats of this wash give a dry and wet wipe-resistant surface. Earthen pigments can be substituted for some portion of the lime.

Borax-casein wash

Borax can be used instead of hydraulic lime. It reacts chemically with casein in a way similar to lime. With high borax content, crystals form, which can be seen in the wash. Unlike lime, borax does not give a white colour, and is therefore preferable if dark colours are desired. Chalk powder is added in order to make the paint thicker and lighter in colour. A small addition of clay powder increases its workability.

If casein powder is being used instead of fat-free cheese, it must be allowed to swell under water for three hours (320 g casein powder in 1 litre of water). Afterwards, 65 g of borax dissolved in 1 litre hot water is mixed into the casein slurry and the whole thinned with 12 litres of water.

Colourless casein coating

In order to retain the natural colour of the loam surface while improving its wipe resistance, a coating of the following mix can be used: 1 part fat-free cheese with 1.8 to 2 parts water and $\frac{1}{8}$ to $\frac{1}{9}$ part of hydraulic lime powder. This coating will give a colourless to slightly milky surface, with a mild silky sheen caused by its fine crystal structure.

Lime-suet coating

The following recipe from Nepal gives a thick, pasty weatherproof exterior coating: 15 kg of powdered quick lime together with

12.1 μ -values of water-repellent loam plasters and s_d -values of coatings

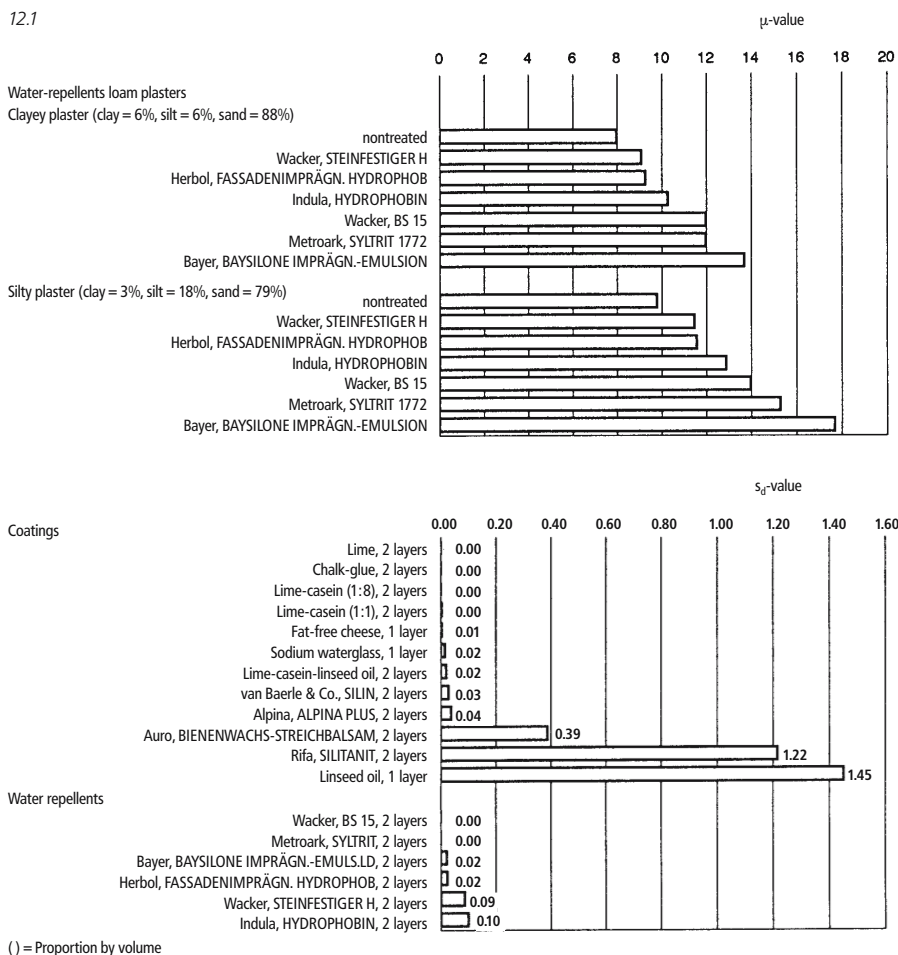

6 kg of tallow (melted suet) is poured into 36 litres of water. This mixture is stirred carefully (care has to be taken because the lime reacts very intensely with water and may splash and burn the skin). After adding 6 kg of kitchen salt and carefully stirring, this mix should be allowed to stand for 24 hours in a not-too-cold environment. The water layer that forms on the top of the mixture is decanted. The pasty mix that remains is then mixed with 3 kg of fine quartz sand and applied with a brush in 3 to 5-mm-thick layers to the wall (Manandhar, 1983). This coating requires several weeks to cure. In Nepal, it is said to last for four to six years. A similar recipe was used successfully in Australia (Department of Housing, 1981). Tests performed with this mix at the Building Research Laboratory (BRL) showed that it bonds well with a rough, lean loam plaster. But with a rammed earth surface made of clayey loam, parts of the coating became detached over a period of several months due to rain and frost, probably because the bond between the coating and the ground was insufficient.

Other stabilised lime washes

Several old text sources claim that in addition to mixing hydraulic lime into whey, it can also be mixed into urine. Weiss (1963) found that using Kaolinite clay, strength could be increased by adding urea and ammonium acetate. This practice was also common in ancient China, where extremely thin porcelain was produced by adding putrefying urine to the mix.

According to Jain et al. (1978), the addition of 70 g of animal glue dissolved in 0.5 litre of boiling water and mixed with 1 kg of hydraulic lime proved good.

In Auroville, India, the following coating was used successfully for mud brick domes: the whites of 60 eggs mixed with 2 litres of buttermilk and 5 litres of palm liquor stirred and mixed with 40 litres of shell lime and 4 litres of cement (Pingel, 1993).

According to various sources, the following plant matter added to the lime also enhances wipe and weather resistance:

- rye flour glue (15 litres of rye flour boiled in 220 litres of water with the addition of some zinc sulphate),
- agave juice,
- boiled banana leaf juice,
- juice of the cactus opuntia,
- juice of euphorbia lactea,
- kapok oil
- raw and double-boiled linseed oil.

Cellulose glue paint

Since it is very cheap, cellulose glue mixed with chalk powder is often used for painting interiors. However, it offers little weather resistance. Its wipe resistance is also low.

Bitumen coating

Bituminous emulsions offer good weather protection for exterior walls. The following recipe was successfully tested at the Central Building Research Laboratory (CBRI), Roorkhee, India: 1 part of bitumen ^{80/100} is heated in a container with 2 parts of naphtha. This mix is then applied with a brush to a dry loam surface. After this coating is dry, a second layer is applied. In order to protect the black surface thus formed by the sun, a final coating of lime is recommended, which is made of 70 g of animal glue mixed into 1 kg of hydraulic lime dissolved in 0.5 litres of water (Jain et. al., 1978).

Vapour diffusion

Coatings can significantly reduce the vapour diffusion of walls. It should be remembered that in cold climates, the vapour barrier effect of these coatings should be less on the outside than on the inside.

The vapour diffusion properties of paints available on the market are not mentioned in their packaging, so experience is important in judging their characteristics. Results of tests conducted by the BRL made with several paints, coatings, water-repellent plasters and water repellents are shown in 12.1.

Water penetration

The capillary water intake (see chapter 2, p. 27) of loam surfaces is significantly influ-

Paint	g/m ²	kg/m ² h ^{0.5}	
Without	0	9.5	
Linseed oil	400	0.0	
Lime-casein 1:1	420/350	0.6/1.5	0.6hr/6–24hrs
Lime-Casein 1:8	300/300	0.7	
Silin-paint (van Baerle)	700/250/310	0.3	
Hydrophob (Herbol)	390/390	0.0	
Baysoline LD (Bayer)	400/290	0.2	
Syltrit (Metroark)	350/320	0.0	
BS 15 (Wacker)	450/430	0.1	
Steinfestiger H (Wacker)	290/290	0.0	

12.2

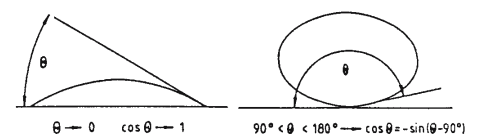

12.3



12.4

12.2 w-values of loam plasters with coatings

12.3 Drop of water on a surface that has been treated with water repellent (right, angle larger than 90°) and on an untreated surface (left, angle smaller than 90°)

12.4 Simple spraying test (BRL)

12.5 Church of San Francisco de Asis, Ranchos de Taos, USA

enced by their coatings. Table 12.2 gives some capillary water intake coefficients (w -values) of loam plaster with and without a variety of treatments:

Making surfaces water-repellent

Water repellents

Several colourless liquids can be used to impregnate loam surfaces, making them water-repellent. A given impregnated surface is considered water-repellent if the wetting angle of contact made by a drop of water is greater than 90° (12.3). The water-repelling agent penetrates into the pores of the loam without closing them, so that while capillary water intake is significantly reduced, vapour diffusion is not. As a rule, these substances are dissolved in organic alcohols, hydrocarbons or water.

The following groups of repellents can be distinguished:

- silane and siloxanes
- polysiloxanes (silicone resins)
- siliconates
- acrylic resins
- silicate ester with hydrophobising additives
- silicates with hydrophobising additives.

Silane, siloxanes and silicone resins react chemically with mineral substances in the loam and are highly weather-resistant; they reduce water intake by more than 90%. Vapour diffusion is decreased by only 5% to 8%.

Silicate ester and acrylic resins show similarly promising water-repelling effects, but they reduce vapour diffusion by 15% to 30%. Since the water repellents found on the market have different compositions and varying effects, they should be tested before use. The water absorption coefficient w of different loam plasters which were flooded twice with different water repellents lies between 0.0 and 0.2 kg/m²h^{0.5} (see 12.2).

Application of water repellents

With the so-called “flooding” technique, water repellents are applied at least twice,

with the solution applied with rollers, so that the liquid oozes and runs off as the roller is pulled down over the surface. The second flooding has to be done before the first is dry. The loam surface has to be dry, and neither cooler than 8°C nor warmer than 25°C before being treated. Only silanes and siloxanes require the ground to be somewhat moist. Normally, this application has to be repeated every few years owing to the deteriorating effect of weather on these repellents.

Testing

A simple method of checking the amount of water repulsion, used by the BRL, is shown in 12.4. Here, the treated test samples are rotated at the rate of 7.5 rotations/min on a base and passed under a shower where water at 36°C is sprayed at a rate of 12 litres per minute through an ordinary hand shower. Another more sophisticated apparatus was described in chapter 2, p. 26.

Lime plasters

Loam plasters used on exterior walls (described in chapter 11) are only suitable if they are without cracks and water-resistant. As a rule, exposed surfaces should not have loam plasters, the most common alternative being lime plaster. Cement plasters are not appropriate, as they are too brittle. They cannot withstand strong thermic and hygric forces without cracking, allowing water to penetrate the loam to cause swelling, which

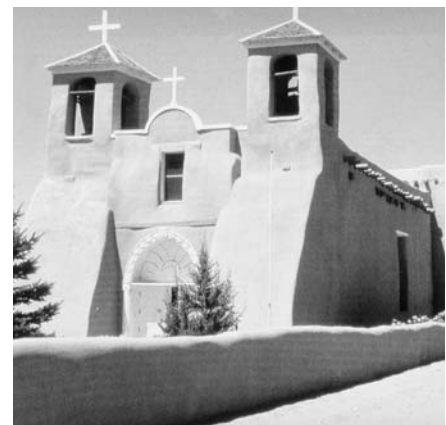

12.5

in turn enlarges cracks and even causes plaster to flake off.

During repairs undertaken in 1992, the oldest German rammed earth house, built in 1795 (1.10), was found to have massive frost erosion, which had destroyed the loam up to a depth of 20 cm, because water had penetrated through cement plaster applied some decades before. A similar phenomenon was reported from New Mexico, USA by Bourgeois (1991). During a restoration carried out in 1967, the church in Ranchos de Taos (12.5), constructed of adobes in 1815, was covered with cement plaster. Eleven years later, the cement plaster had to be dismantled when the loam below showed heavy moisture damage.

In cold climates, quick drying of the wall is necessary if rain penetrates from the outside or if vapour condensation from the inside occurs. Therefore, the vapour diffusion resistance of the outer layer should be lower than that of the inside.

The German standard DIN 18550 (Part 3) states that water-repellent external plasters should fulfil the following conditions: water absorption coefficient $w \leq 0.5 \text{ kg/m}^2 \cdot \text{h}^{0.5}$, the specific vapour diffusion resistance s_d must be $\leq 2.0 \text{ m}$ and the product $w \cdot s_d \leq 0.2 \text{ kg/m} \cdot \text{h}^{0.5}$.

The following sections describe the composition and application of non-loam containing plasters.

Preparation of ground

To provide a good bond, loam surfaces that are to be plastered should be dry and rough. Smooth surfaces should be sprayed with water, so that their outer layers will moisten and swell, after which they can be grooved diagonally 2 to 3 mm deep, as shown in 11.2. While the surface so prepared is still moist, it should be primed with thin lime milk, which should penetrate the ground up to a depth of several millimetres. A mix of 0.5 to 1 part of fat-free white cheese, 2 parts hydraulic lime and 30 parts water has also proved successful. If the lime plaster is exposed to severe thermal forces,

if the unbroken area of the plaster surface is very large, or if the bond is poor, expanded metal meshes or reed mats fixed to the ground may be required to take the plaster. When using reed mats, it is advisable to dip them in lime milk to prevent rotting.

Reinforcement

Larger unbroken panels subject to strong thermal forces may require reinforcement. For this purpose, a galvanised steel net with hexagonal meshes (rabbit or chicken wire mesh) or similar nets are commonly used. Workmen often prefer using plastic covered glass-fibre nets because they do not corrode and are more pliable.

Composition

Normal lime plaster usually consists of 1 part hydraulic lime and 3 to 4 parts sand. Since it is commonly used in construction worldwide, it is not discussed further in this book. However, lime-casein plasters are less common, and are therefore described below.

Old recipes often prescribe that animal hair and casein be added to a normal plaster to improve its behaviour. In former times, casein was added in the form of whey or buttermilk. Casein and lime react chemically to form calcium albuminate, a wash-resistant compound. The addition of casein reduces the water absorption of lime plaster, but at the same time hinders vapour diffusion.

At the BRL, a lime-casein plaster for exterior work was successfully tested. The mix consisted of fat-free cheese, hydraulic lime and sand in a ratio of 1:10:40. The lime has to be first intensively mixed into the cheese to form a creamy paste without adding any water. After allowing the mix to rest for a while, water and sand should be added. For a thinner plaster that can be brushed on, a slightly different mixture might be adequate, with the proportion 1:6:25 of the same ingredients respectively. In warm climates, some kitchen salt should be added to keep the lime plaster moist for a longer period, which improves curing.

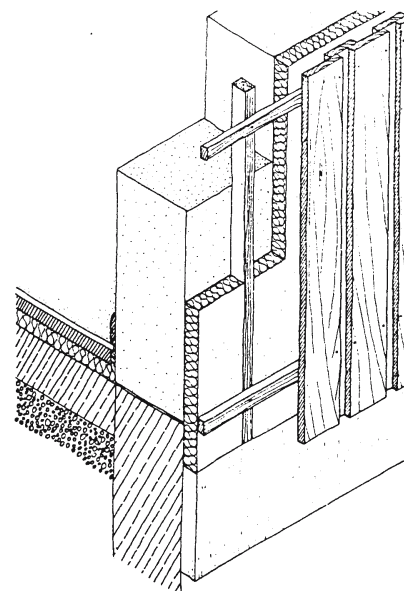

12.7

12.6 μ -values of lime plasters (figures referred to as volumetric parts)

12.7 Loam wall with additional exterior insulation and wooden planks forming air cavity

12.8 Plinth designs made incorrectly and correctly

Lime	Trass-lime	Sand	Fat-free cheese	Linseed oil	Clayey loam	Cow-dung	μ -value
1	-	3	-	-	-	-	11.2
-	1	3	-	-	-	-	10.8
1	-	6	0.5	-	-	-	6.2
1	-	15	0.5	-	3	-	9.7
1	-	3	-	0.05	-	-	15.2
1	-	3	0.25	0.05	-	-	28.5
1.5	-	10	-	-	2	6	8.0

12.6

12.8

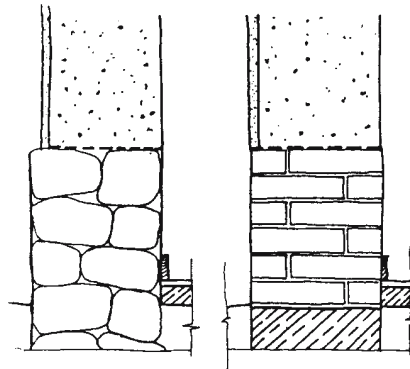

A

B

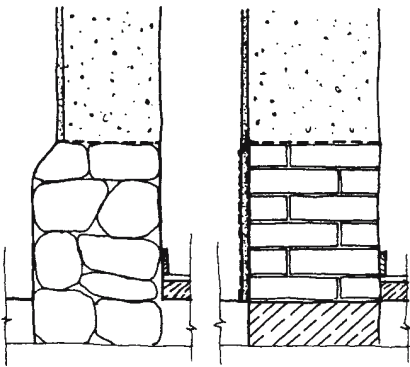

C

D

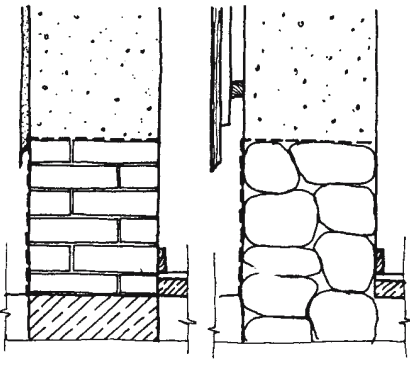

E

F

Application

Before applying the plaster, the loam surface should be moistened and primed with lime-casein milk. The plaster is then applied in two layers, bringing the total thickness up to a maximum of 20 mm. In the first layer, some cement can be added for faster curing. The second layer should be applied while the first is still slightly moist. When shrinkage cracks occur, these should be moistened with a brush dipped in lime milk and then closed by rubbing with a trowel. It should be noted that lime plasters cure when in contact with carbon dioxide from the air, and this process is only possible in the presence of sufficient moisture. Therefore, walls should be sheltered from direct sun and wind, or kept moist with a damp fabric.

Internal plasters can be applied in one layer. Gypsum plaster or gypsum-lime plaster, with or without casein, can also be used in internal work. Cement plasters, however, should not be used even for internal work.

Effect on vapour diffusion

The effect of adding double-boiled linseed oil and casein on reducing the vapour diffusion of lime plasters was tested at the BRL. The values of the vapour diffusion resistance coefficient μ obtained are listed in table 12.6.

Shingles, planks and other covers

Besides plasters and coatings, shingles, planks, larger covering panels or baked brick walls separated by an air cavity can be used to protect loam walls. These methods are especially useful if additional thermal insulation is to be applied from the outside. A common method is shown in 12.7. In Mesopotamia (Iraq), layers of glazed baked bricks have sheltered adobe walls for thousands of years. It is always advisable to separate such covering layers from the wall with an air cavity, so that rain that penetrates can drain out and does not harm the wall.

Structural methods

Protection from rain

One method of preventing rain from coming into contact with a loam wall is to provide it with a roof overhang. A sufficiently high plinth (30 to 50 cm) can protect from splashing rain. The joint of the wall with the plinth has to be carefully designed so that the rainwater can flow down unhindered without entering the joint between wall and plinth. In 12.8, solution A is unacceptable. Solutions B and C may be acceptable in areas with little rain. Solution D is common, whereas E and F show perfect designs for combating this problem.

Protection against rising damp

Exterior loam walls have to be protected from rising damp in the same way as baked brick or stone masonry walls. A damp-proof course, usually bituminous felt, and sometimes plastic or metallic sheets are used. As these means are fairly expensive in the developing world, a 3 to 4-cm-thick rich cement concrete layer is often used as an alternative. This should be impregnated with bitumen or waste mobil oil.

Protection against flooding

In kitchens and bathrooms, the plinth should have a waterproof skirting of tiles, slates, rich cement plaster etc. The skirting design should prevent water from leaking or broken pipes, which could flood floors, from reaching the loam wall.

13 Repair of loam components



13.1

Repair of damaged sections of loam, especially cracks and larger joints, demands special measures differing from those used for conventional masonry or lime plasters. This chapter describes loam-specific repair problems and retrofitted thermal insulation methods using lightweight loam.

The occurrence of damage in loam components

Damage in loam components can occur due to shrinkage by thermal contraction and expansion, through water impact or by mechanical impact and abrasion. If a plaster contracts when drying, or does not bond sufficiently with the ground sur-

face, it may separate from it. Such weak areas can be easily located by knocking the plaster with the knuckles. If large quantity of water condenses in the wall and cannot be removed quickly enough, the loam might swell and cause the plaster to crumble and fall off. Such damage can also occur when water seeps through from the outside through cracks or holes.

Frost can also cause a similar damage if the wall is moist and the freezing water expands.

Repair of cracks and joints with loam fillers

Joints and cracks in dry loam components cannot be repaired with plastic loam as this does not bond with the dry loam surface. When drying, the filler will separate out and can fall off. Therefore, it is important to pre-treat the joint and use a mixture having as little shrinkage as possible.

Mixtures

While designing the composition of the loam filler for cracks and joints, the following should be considered:

- The filler must have sufficient binding force to stick to the moistened surfaces of the crack or joint.
- The mix should contain sufficient coarse sand or other coarse particles so as to minimise the shrinkage. Fibres or hair may also be added for the same reason.

- In order to decrease the curing time, gypsum, lime or cement can be added. As these additives also make the mixture leaner, the shrinkage is reduced. The disadvantages while adding these substances might be that the binding force and the compressive strength are reduced.

Joints and cracks in internal elements can be filled with a mixture of 1 part loam, 0.5 to 1 part hydraulic lime and 0.5 to 1 part gypsum.

If the joints are exposed to weather, gypsum should not be used, but cement, high-hydraulic lime or a mixture of these totalling from 8% to 20% can be used as an additive. Instead of these binders 4% to 7% double-boiled linseed oil can also be added. This filler stays plastic for several weeks.

Application of filler

In order to get a good bond between the old loam surface and the filler material, cracks should be opened up to 1 cm with loose particles brushed away and the edges of the joints sufficiently moistened so that the loam swells and gets plastic on the surface. When double-boiled oil loam is used as filler for repairing, the surface has to be treated with linseed oil.

The plastic filler is first applied with a knife to both sides of the joint, and the opening then filled with a drier mixture of the same filler, tamped or hammered into the joint (see 8.29). It is advisable that the joint is filled with more material than is necessary, so that when after the filler shrinks on drying, it can be compacted again when still slightly moist.

Repair of cracks and joints with other fillers

The repair of cracks and joints with a loam filler is very time-consuming and requires some experience. However, other fillers which show less shrinkage and better bonding qualities and require less labour and skill are described in this chapter.

Mixtures

As an alternative to loam fillers, all materials that can be commonly used for plasters can be used as fillers. High-hydraulic lime, cement, gypsum, casein, cellulose and double-boiled linseed oil can be used as binders. Silt, sand, and gravel as well as organic aggregates like cork, sawdust, cereal and rice husks, and shredded newspaper can be used as fillers. When repairing external joints, organic matter should not be used except when the mix has a high pH-value (which prevents growth of micro-organisms). Acrylic or silicone elastic synthetic mixes can also be used as fillers. Silicone bonds with loam, provided the joint surface is dry and free of loose particles before application.

Repairing larger areas of damage

Repairing with loam

Larger eroded or flaked areas should be repaired by scraping off all loose loam and then wetting the surface before applying new loam, as described in chapter 11 on loam plasters.

In order to reduce shrinkage, each layer of loam plaster should not be thicker than 1 to 1.5 cm. If the damage is more than 2 cm deep, it is advisable to scrape the area to a depth of 4 to 6 cm. This is then filled with broken adobes and lean mortar. In areas prone to frost, green bricks are not advisable as they are not frost-resistant.

Coatings

If the coating of a loam surface is to be repaired, the old coating should first be scraped off. The area is then primed before the new coating is applied. For this, lime-casein milk can be used, as described in chapter 12, p. 99.

If the surface is very sandy and soft, a primer of lime-casein glue is better. This is prepared from 1 part hydraulic lime and 5 parts fat-free cheese mixed intensively for two minutes without the addition of water. The mixture is allowed to stand for a while

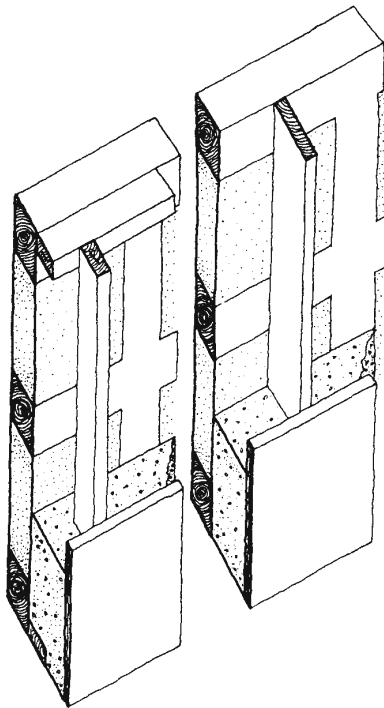

13.2

13.1 Pumping lightweight mineral loam
13.2 Additional interior thermal insulation layer of lightweight mineral loam in a timber frame wall

and then thinned with water in a 1:5 proportion. This glue should be used within one hour (Letzner and Stein, 1987, p. 145).

Retrofitting thermal insulation with lightweight loam

This section describes the general physical and structural aspects that have to be considered while enhancing the thermal insulation of existing exterior walls by using lightweight loam. Different types of suitable aggregates are described in chapter 4, p. 47. The use of lightweight loam as infill for timber-framed houses is mentioned in chapter 9, p. 82, and highly insulating earthen wall designs are discussed in chapter 14, p. 106.

Condensation

The later 20th century saw considerable damage to historic timber frame houses in Germany. Most of it occurred due to condensation in walls, a type of damage that had not earlier occurred.

Much more humidity is produced in kitchens and bathrooms nowadays than in previous times. While today a daily warm shower is common, earlier, people used to wash with cold water in a basin. Furthermore, clothes were washed outside the house in an outhouse or open area and dried in the open. Today, clothes are usually washed and dried within the house. All of the above factors contribute to the production of much higher humidity in the timber frame house today. Also, indoor temperatures are much higher nowadays in comparison to earlier times. Therefore, though the relative humidity of indoor air may be about the same, the absolute humidity is significantly higher. Furthermore, doors and windows in timber frame houses today are much better sealed. Therefore, the air exchange rate is greatly reduced. All these factors lead to a much higher condensation within the walls. Therefore, it is imperative that the vapour diffusion characteristics of the walls are carefully controlled.

Thermal insulation

The exterior walls of typical timber frame houses have thicknesses of 14 to 20 cm. The infill of the timber frame consists of baked bricks, adobes or wattle-and-daub. The U-value of these infills is between 2.0 and 2.7 W/m²K. Taking the timber frames into account, this gives an overall U-value of 1.2 to 2.2 W/m²K. Heat transmission through these walls is thus three to six times higher than it should be by modern standards in moderate and cold climates. The simplest solution, and the best in physical terms, is to increase thermal insulation from the outside, that is to say, to envelope the building in thermal insulation. If the house is a historical landmark and therefore not allowed to be covered with thermal insulation from the outside, the additional thermal insulation has to be applied from the inside. This usually causes problems because in practice, heat bridges and vapour bridges cannot be totally avoided. These can lead to partial moistening of the wall because of a high degree of condensation, and subsequently to damage of the wall surface. Furthermore, it increases the heat loss and might lead to fungus growth.

Lightweight loam layers

One possible method of applying additional interior thermal insulation is shown in 13.2. Here, a formwork is fixed to spacers mounted on the historic wall, and a layer of lightweight mineral loam is poured or pumped in. It is important that there be no space formed between the two leaves so that the transport of capillary water and vapour is not hindered.

In the project shown in 13.1, five people took eight hours to complete 60 m² of this wall, using the pumping method as described in chapter 10, to apply a 15 to 25-cm-thick layer of lightweight loam. Illustration 13.3 shows the finished surface of this wall after the formwork was removed. The material has a density of about 1000 kg/m³. This relatively high density was chosen in order to get sufficient noise insulation, heat storage and humidity balancing effects.

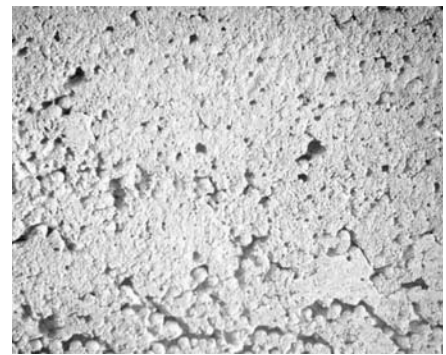

13.3

The same method can be used to build up exterior thermal insulation, but here, a loam mixture with lower density is recommended.

Prefabricated elements

An even simpler method of building an interior thermal insulation layer is to use prefabricated loam elements like larger blocks or panels, as described in chapter 7, or to use lightweight loam-filled hoses as described in chapter 10. These can be laid without formwork in a plastic state against the wall in one or two layers, as shown in 13.4. In this case it is preferable to flatten them and fix them to the existing wall with steel wire hooks (4 hooks per m²).

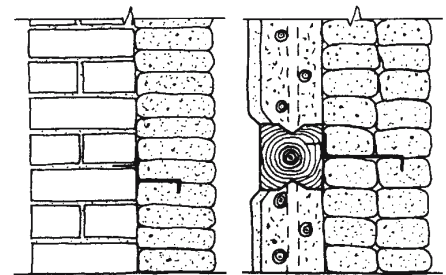

13.4

13.3 Surface of a lightweight mineral loam wall with a density of 1,000 kg/m³ after the formwork is removed

13.4 Additional interior thermal insulation using hoses filled with lightweight loam

14 Designs of particular building elements

Joints

When loam elements are joined to posts, beams, windows or doorframes, the following considerations have to be kept in mind:

- With the wet loam techniques a gap occurs at the joint due to the shrinkage of the loam.
- Even when the loam is dry or when dry loam elements are used, gaps may occur due to the contraction of the timber during

its drying, a process which might take up to two years (till the timber achieves its equilibrium moisture content).

- Timber structures continue to swell and shrink slightly in use due to adsorption and desorption of humidity.

Illustration 14.1 shows some possible joint designs of *stranglehm* respectively loam-filled hoses, adobes and lightweight loam with posts of timber or brickwork, or with door and window frames of timber.

14.1 Possible joint designs of *stranglehm* respectively loam-filled hoses, adobes and lightweight loam with posts of timber or brickwork, or with door and window frames of timber. (horizontal sections)

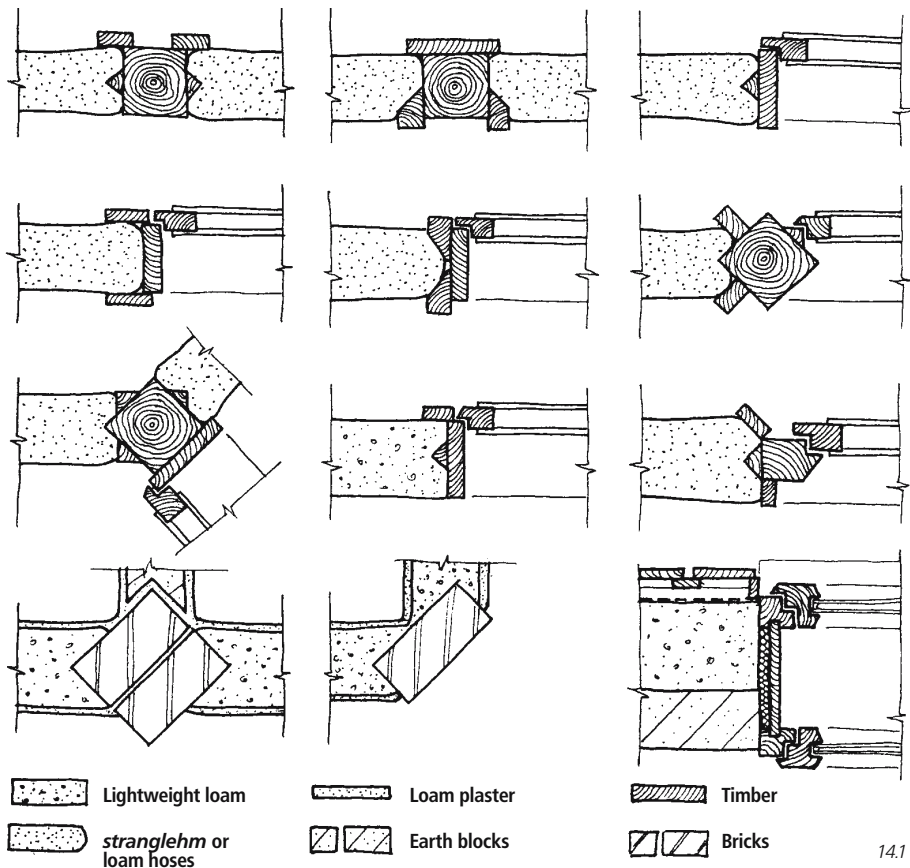

14.1

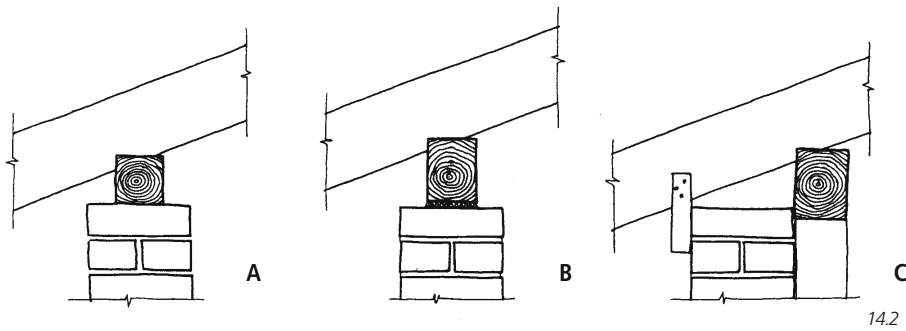

14.2

Roof rafters should not rest directly on the earth wall, but instead on timber wall plates or beams as seen in 14.2 A. If the rafters rest on a timber post-and-beam structure and the wall is not load-bearing, the shrinkage of the timber structure has to be taken into account.

In 14.2 B, an elastic sealant has been introduced between the beam and wall in order to provide sufficient tolerance for this shrinkage; while in 14.2 C, the structural system is separated from the wall, thereby allowing a greater vertical movement of the timber structure.

Particular wall designs

Loam walls with high thermal insulation

The U-value of a 30-cm-thick rammed earth wall (without lightweight aggregates) is about $1.3 \text{ W/m}^2\text{K}$. In order to achieve a U-value of $0.3 \text{ W/m}^2\text{K}$ with this wall, it would need to be 1.65 m thick. This shows that in cold climates where high thermal insulation is required, it is not possible to build only with normal loam.

The examples provided in 14.3 not only show sufficient thermal insulation with a U-value of $0.3 \text{ W/m}^2\text{K}$, but are also designed to have sufficient thermal mass for balanc-

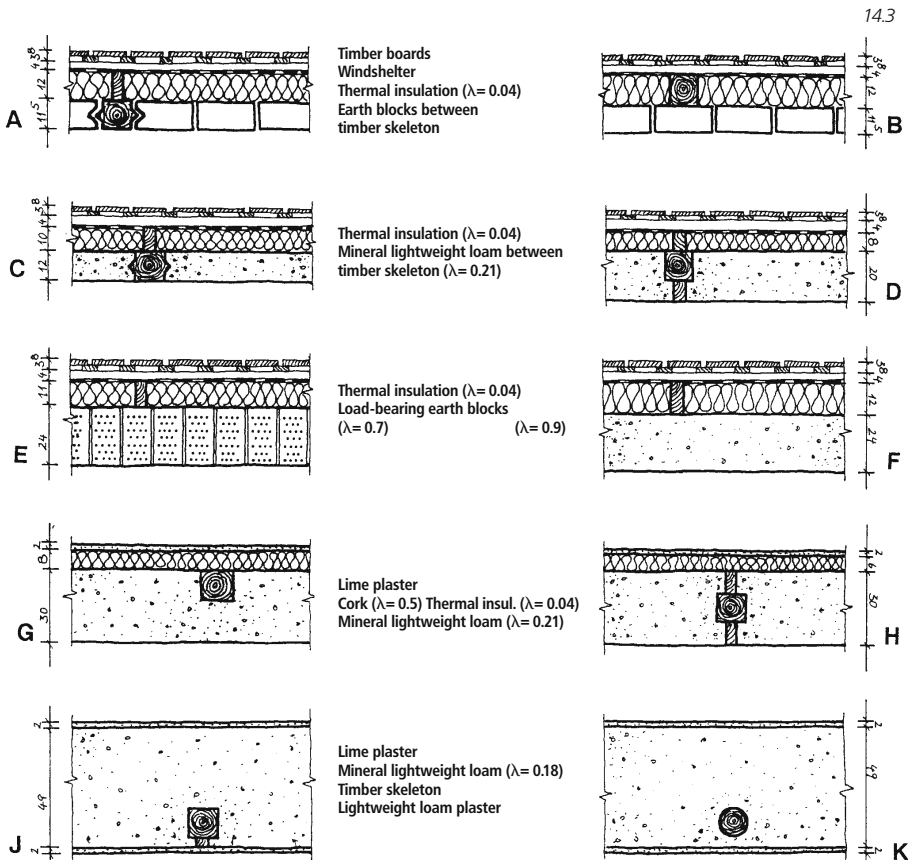

14.3

14.2 Vertical sections of roof structure and load-bearing and non-load bearing walls

14.3 Horizontal sections of various loam walls with U-values of $0.3 \text{ W/m}^2\text{K}$

14.4 Wall of discarded car tyres filled with soil, USA

14.5 Dome of earth-filled hoses, Kassel, Germany

14.6 Prototype building, Kassel, Germany



14.5



14.6

ing the indoor air temperature, sufficient loam for balancing the indoor air humidity and sufficient noise insulation as well. Designs E and F are for load-bearing walls, while the others are not. The outer thermal insulation panels, shown in G and H, can be used as a lost formwork for pouring the lightweight loam, while also acting as a ground for the external lime plaster. The simplest and best performing solutions are J and K, which are formed with monolithic low-density lightweight loam walls.

In climates prone to driving rain, designs A to F are preferable because they have separated outer leaves, which act as protection from the weather.

Earth-filled tyre walls

A possible method of using hollow blocks filled with lightweight loam for walls has been described in chapter 10, p. 89. If the insulation requirements are not very high, these walls can be filled with plain clayey soil.

14.4

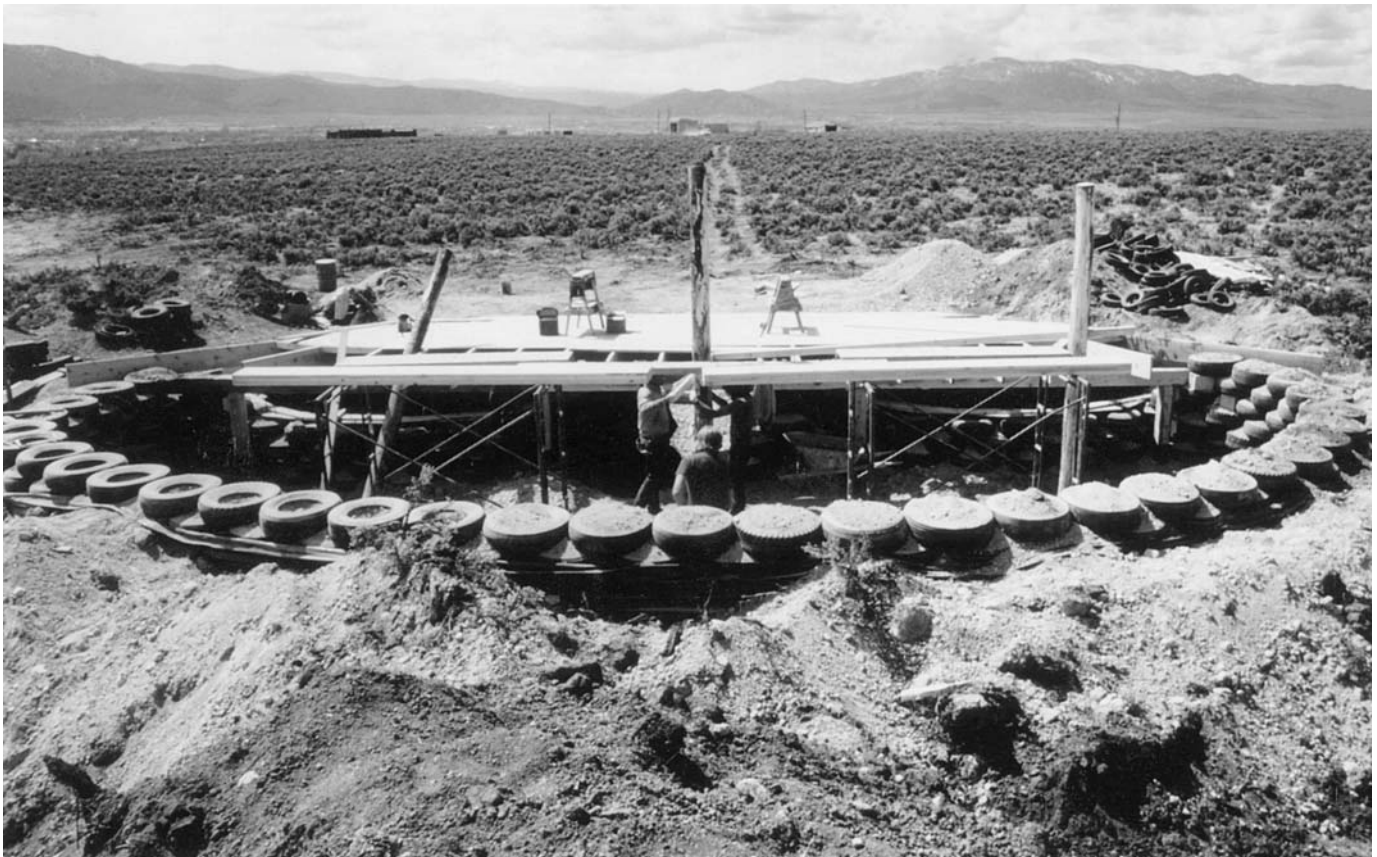

Michael E. Reynolds built several residences in New Mexico, USA, having walls made of discarded car tyres filled with soil dug out of the foundation. Only the top tyre was filled with concrete to which a wooden ring anchor was fixed. The interior surface was covered with expanded metal mesh reinforcement and then plastered.

Earth-filled bags

The Building Research Laboratory (BRL), University of Kassel, Germany, tested several approaches to building walls of earth- or sand-filled bags or hoses. Illustration 14.5 shows a dome built in 1977 of sand and earth-filled hoses of polyester fabric; 14.6 shows the wall of a low-cost housing prototype built in Kassel in 1978. In the latter case, the hoses were made of jute fabric covered by several layers of lime wash to prevent rotting.

The California architect Nader Khalili further developed this idea utilising endless hoses, usually used to make bags for sugar or flour. Illustrations 14.7 and 14.8 show the filling and the ramming process; 14.9 displays a built example in Brazil.



14.9

Intermediate floors

Traditional loam floors

In traditional German timber frame houses, the intermediate floors were filled with loam to increase fire resistance, sound insulation, and sometimes thermal insulation as well. The traditional techniques described here are very labour-intensive and, therefore, are used nowadays in renovation work only if required by historic landmark preservation codes.

- 14.7 Filling of hoses
- 14.8 Ramming of hoses
- 14.9 Residence, Brazil
- 14.10 Rammed earth flooring on joists
- 14.11 Spalier flooring
- 14.12 Flooring made of straw loam rolls
- 14.13 Vertical section through timber flooring with infill of green bricks
- 14.14 Earthen jack vault flooring

14.7



14.8



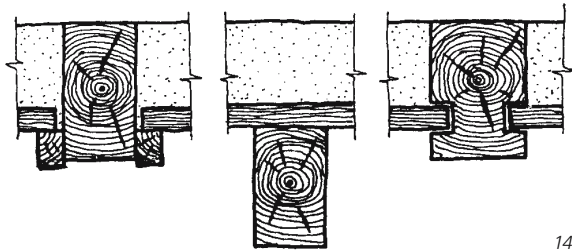

14.10

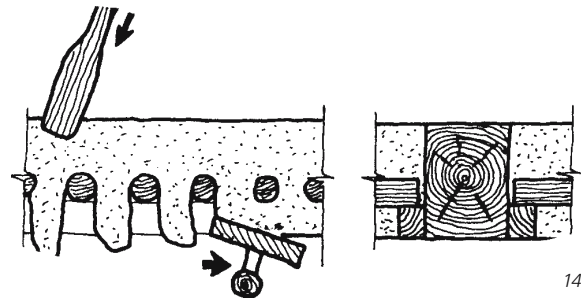

14.11

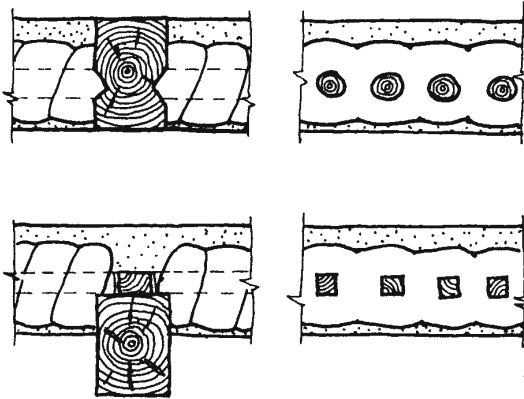

14.12

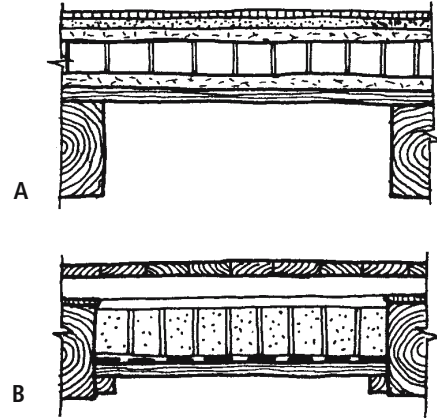

A

B

14.13

Rammed earth decks

Illustration 14.10 shows three different ways of using rammed earth as infill between or on top of wooden beams. The ceiling is formed of exposed timber boards, on top of which moist earth is compacted. A layer of straw is laid onto the boards to prevent loam from falling through gaps. Nowadays, oilpaper is used for the same purpose.

made in the same way as described in chapter 9, p. 81. A bundle of straw is dipped into loam slurry and wound helically around a stick, forming straw loam rolls. The sticks in these rolls either rest on top of the beam, or else are inserted into slots on the sides of the beams (14.12).

Modern loam floors

Today, instead of earth infill for wooden beams and board floors, green bricks or adobes without mortar can be used, which eliminates drying time. Illustration 14.13 A shows a favourable design of such a floor, which provides sufficient insulation against airborne and structural noise. The design shown in 14.13 B has the same properties, but also offers the advantage of lower structural height and the disadvantage of being more labour-intensive.

Illustration 14.14 shows various designs for vaulted loam floors. Designs A, B and C use earthen blocks, which transfer slab loads to the beams by vault-action under compression. Design D shows a non-load bearing loam vault made by pouring lightweight loam over a curved reed mat.

"Spalier" decks

Illustration 14.11 shows the traditional German *spalier* floor where wooden lathes are laid at a distance of 3 to 6 cm between the floor beams. Straw loam is pressed from above so as to form "tongues" between the lathes. The tongues are later pressed to cover the lathes from underneath by a trowel so as to form an even surface as shown in the figure. A variation of this floor was also traditionally used where, instead of using the trowel, a horizontally moving formwork was employed.

Straw loam rolls

Another traditional German technique employs straw loam rolls (German: *Wicke*)

14.14

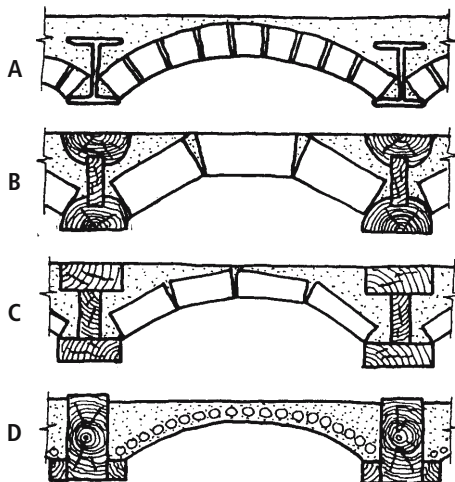

A

B

C

D

Rammed earth floorings

Hard-wearing floor surfaces need to meet very high standards. They must resist pressure abrasion, be waterproof and show no cracks. It is very difficult to build such surfaces from loam, but if carefully done, it is not impossible. The most difficult criterion is to achieve sufficient strength against abrasion or surface hardness (see chapter 2, p. 34). It is often easier to avoid the effort involved in achieving this by using brick, timber or stone floor tiles over the loam, or by covering the loam with a carpet, rug, fabric etc.

Traditional earth floorings

Illustration 14.15 shows Niemeyer's version of a traditional loam floor (Niemeyer, 1946). The base layer consists of loam, about 15 cm thick, with high clay content. This acts as a water barrier, and is applied in two layers that are compacted by beating or ramming until no cracks appear while drying. The next layer consists of coarse gravel, which interrupts capillary action. Above this, a 10-cm-thick layer of straw loam provides thermal insulation. An additional 4-cm-thick layer of straw loam, stabilised with cement in the proportion 1:6 (1 part cement : 6 parts straw loam), is added so that heavy loads can be carried. As the final layer, Niemeyer recommends a 2-cm-thick layer of cement mortar with sawdust. Two coats of water-glass are then applied while the final layer is still moist. Finally, after it is completely dry, the surface is waxed.

The author of this study suggests reversing the sequence of the bottom two layers. To interrupt capillary action, coarse gravel should be used as the lowest layer. Loam with a high clay content should form the next layer, acting as a water and vapour barrier (damp-proof course). As described below in this chapter, stabilised loam mortar may be substituted for cement mortar. In traditional German farmhouses and barns, earth floors were built in a similar way, so that even cars (without pneumatic tyres) could drive over them. Instead of the

cement plaster surface, loam plaster that contained loam with a high clay content and large amounts of coarse sand and fine gravel was used. This was applied in a 7-cm-thick layer and compacted by beating. In order to harden the surface, it was sprinkled with Fe_3O_4 flakes (flakes produced by forging glowing iron) and beaten into the surface together with cow's blood, cow's bile or tar.

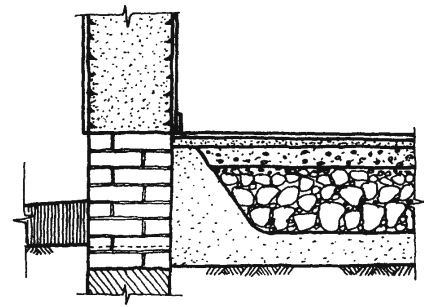
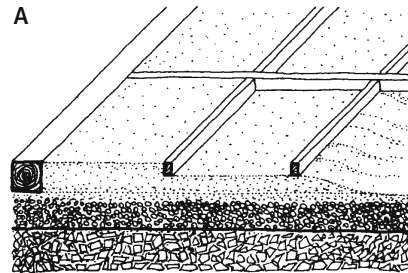

14.15

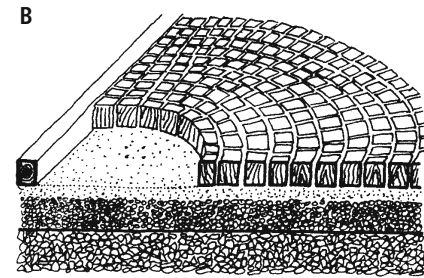

14.16

Modern earth floorings

In 1984, the two different loam floors shown in 14.16 were successfully tested at the BRL. Design A has a surface, hard enough to be walked on, that is divided by a timber grid, while design B shows a loam floor paved with timber blocks.

The subflooring is identical in both cases, consisting of a 15-cm-thick capillary breaking layer of gravel, followed by a water and vapour barrier of plastic or bituminous felt paper, and topped with a 10-cm-thick layer of expanded clay that acts as thermal insulation.

The first layer of moist clayey loam is placed on top of this subflooring and rammed (14.17 and 14.18). In both cases, a primary grid of timber battens (10 x 10 cm) is laid over this.

In design B (14.16), this grid is then filled with timber blocks laid with a loam mortar stabilised with 6% to 8% (by volume) of double-boiled linseed oil. The blocks are placed so that the annular rings are exposed (14.20).

In design A, a second layer of loam mortar is applied and rammed, over which a secondary grid of timber strips is laid. The

14.15 Traditional flooring for living rooms (after Niemeyer, 1946)

14.16 Modern earth floorings (Minke, 2000)

14.17 to 14.19 Making a rammed earth floor
14.20 Making a rammed earth floor with a wood block cover

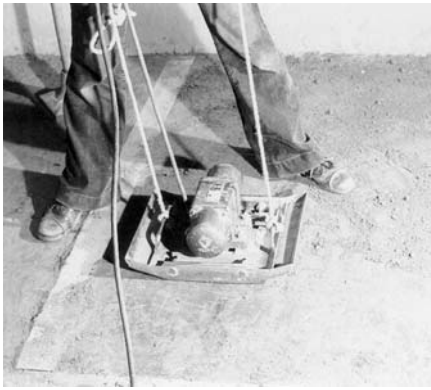

14.17



14.18



14.19



14.20

spaces thus created are then filled with a third layer of loam mortar stabilised with 6% to 8% (by volume) of double-boiled linseed oil. The surface is then smoothed by rubbing with great pressure using a metal trowel (14.19) until the surface becomes shiny.

Since this process is very labour-intensive, the author of this study has developed an alternative design requiring significantly less labour (less than a fifth):

The layers constituting this floor can be seen in 14.21. In order to break up capillary action, the lowest layer is formed by coarse gravel. A damp-proof course of bituminous felt paper is laid over this, followed by a base thermal insulation layer of rockwool. (The latter is necessary only by the stringent demands for thermal insulation contained in more recent German regulations; otherwise lightweight loam would be sufficient.)

A 12-cm-thick lightweight mineral loam is poured on top of this layer. This provides both sufficient thermal insulation and the required structural strength.

The lightweight loam was prepared in a normal concrete mixer and then poured from a wheelbarrow (14.22).

In order to reduce hardening time, 4% cement was added to the mix. In order to achieve adequate surface hardness, a 3-cm-thick loam mortar (containing sufficient coarse sand to minimise the occurrence of shrinkage cracks) was applied in two layers. For this mortar, 6% (by dry weight) of three different stabilising agents were successfully tested: the first, soda waterglass was added after being thinned 1:1 with water; the second, double-boiled linseed oil; and the third, lime-casein glue (made from 1 part hydraulic lime and 5 parts fat-free white cheese mixed vigor-

ously without water for two minutes and then allowed to stand) with additional chalk at the rate of 10%.

The mixtures were applied like plasters with low moisture content and the surface smoothed with a rotary motion of the trowel. After fully drying, all of these surfaces were waxed.

All three mixtures displayed very good surface hardness. The linseed oil mixture had the disadvantage of its strong odour and a long drying time, but showed the best surface hardness.



14.22



14.23

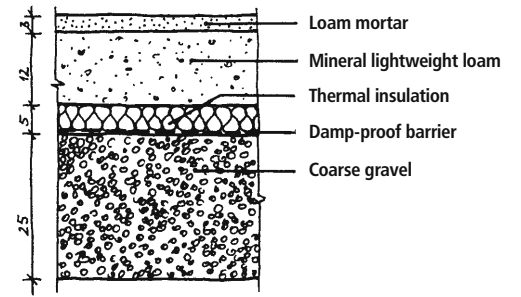

14.21

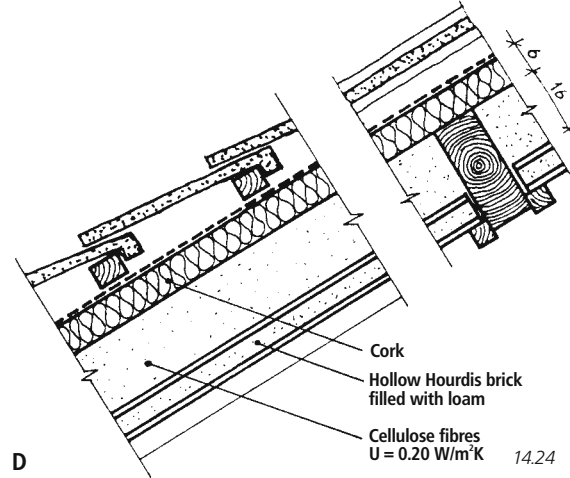
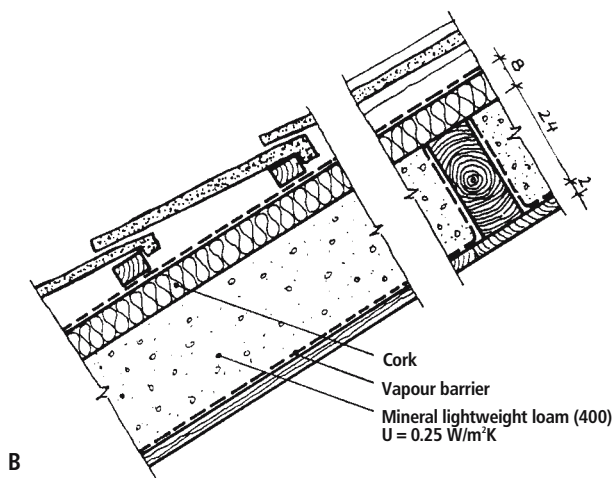
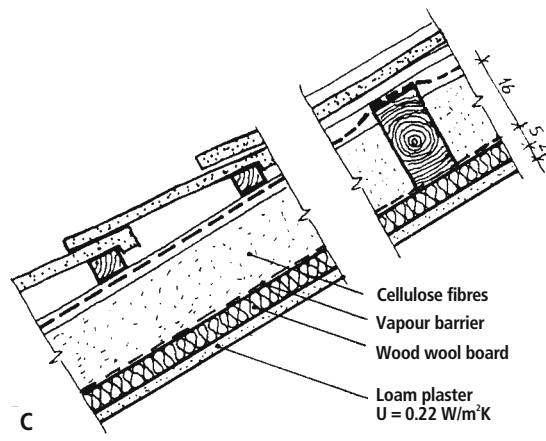
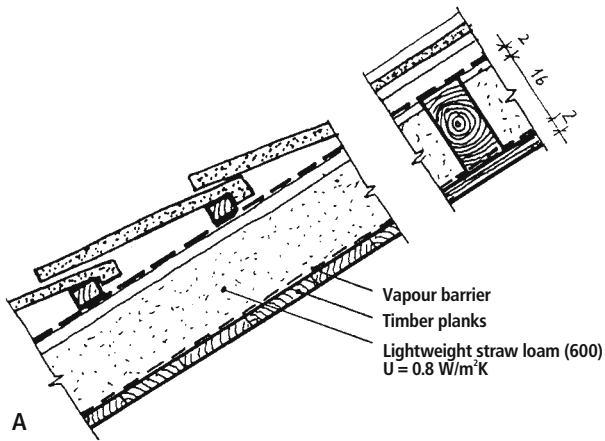

14.24

Inclined roofs filled with lightweight loam

Commonly used tile-covered rafter roofs can be filled with lightweight loam in order to increase their thermal and sound insulation. If the space created by a typical 16-cm-high rafter is filled with lightweight loam with a density of 600 kg/m^3 and the ceiling made of timber boards, the roof achieves an U-value of $0.8 \text{ W/m}^2\text{K}$ (14.24 A). Three solutions, B, C and D, show possibilities for attaining higher levels of thermal insulation, as demanded in many northern countries.

Earth-covered roofs

In dry climate zones, flat roofs covered with earth have been in use for centuries in traditional rural architecture. One of the greatest challenges when building in developing countries is to produce successful, weather-resistant loam roofs that might prove durable in rainy areas. The cost of a typical roof structure in such countries is usually 25% to 30% of total buildings costs. Loam shingles (see chapter 7, p. 70) were propagated in Germany in the early 20th century, and there was even a published

standard, DIN 18957. Some traditional loam-covered roofs and some recent experiments with loam coatings are discussed in this section.

Traditional roofs

In many subtropical, moderate and cold climates, traditional flat and sometimes even inclined loam roofs have been built for centuries. Typical examples are the flat roofs of the Pueblo Indians in New Mexico, USA (see 6.3), and those of the Dogon of Mali, West Africa (14.25).

All flat roofs are similar in construction. Tree trunks or bamboo form the primary structural elements. Branches and twigs are laid on these to form a fairly dense network over which straw loam can be rammed or plastered. The final coarse consists of several layers of clayey loam, usually containing a large quantity of coarse sand; sometimes hair, fibre or cow dung is added and carefully smoothed.

In areas where there is little rainfall, shrinkage cracks are not a problem. When water enters these cracks, clayey loam swells and seals them. Only in some cases are additional coatings used. In Anatolia, Turkey, special clayey soil with a high salt content is taken from the banks of the salt lakes in order to seal loam roofs. Due to the hygroscopic

14.21 Vertical section through a lightweight mineral loam floor
14.22 to 14.23 Making a lightweight mineral loam floor with a loam plaster that is water-repellent and abrasion-resistant
14.24 Vertical section through inclined roofs with lightweight loam infill
14.25 Flat earthen roofs of a Dogon village, Shanga, Mali

14.25





14.26

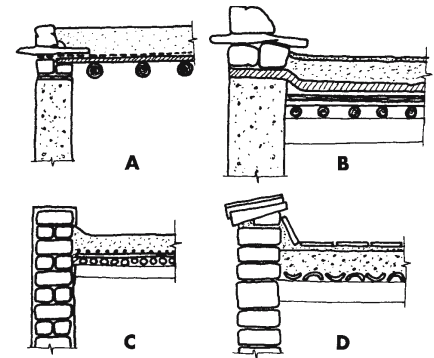

14.27

property of the salt, this loam stays moist for longer periods, and prevents water penetration while it remains in this state. If shrinkage cracks occur during drying, swelling occurs during contact with rain and seals the cracks. Once the rain has washed off some of the salt, reducing the self-sealing effect of the top coarse layer, residents can either sprinkle salt or pour salt water on it to regenerate the seal (Dalokay, 1969).

When making loam-covered flat roofs, it should be kept in mind that roof edges are susceptible to mechanical damage, especially by wind and water erosion. This can be prevented by solutions of the type shown in 14.27. If the surface of the roof is to be walked upon, then tiles are recommended (14.27 D).

Illustration 14.26 shows an inclined roof from northern Venezuela, consisting of layers of cow dung stabilised with straw loam mortar applied in several layers (8 to 12 cm), over a wooden substructure made of branches and twigs. After the rainy season, the top layer is normally redone.

New solutions

In rainy areas, where inclined roofs are common, traditional buildings do not have loam roofs. However, recent experiments

have proved that additives can increase the weather resistance of loam. Bases on test results of the BRL, described in chapter 4, p. 40, a low-cost housing prototype was built at Pujili, Ecuador, by the group FUNHABIT, Quito, and the author. The roof was made of a timber substructure built of tree trunks, branches and reeds. This was covered by several layers of loam plaster that were 8 cm thick in total (14.28). The first layer consists of clayey loam thinned with pumice (0 to 12 mm diameter) and waste mobil oil (52 parts loam : 28 parts pumice : 1 part oil). This mixture, which also provided thermal insulation, was laid in a fairly dry consistency and compacted by beating. The top layer, 2 to 3 cm thick, has the following mix: 72 parts loam, 36 parts pumice (0 to 5 mm), 12 parts cow dung, 12 parts donkey dung, 8.5 parts mobil oil, 6 parts loose Sisal fibres (3 to 5 cm long), and 1 part double-boiled linseed oil. After several days, when the mixture was somewhat dry, it was recompactd with a metal trowel, using great pressure, till the surface was shiny.

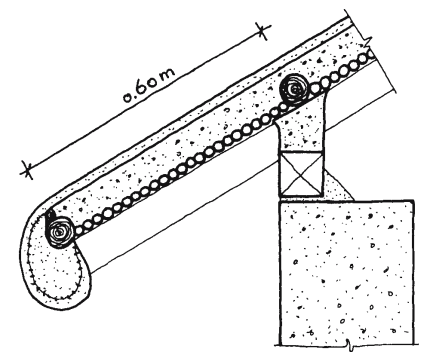

14.28

14.26 Traditional loam roof, north Venezuela

14.27 Traditional flat loam roofs

14.28 Vertical section through a loam roof, Pujili, Ecuador

14.29 Earth block domes, village near Aleppo, Syria

14.30 Earth block domes, Siestan, Afghanistan

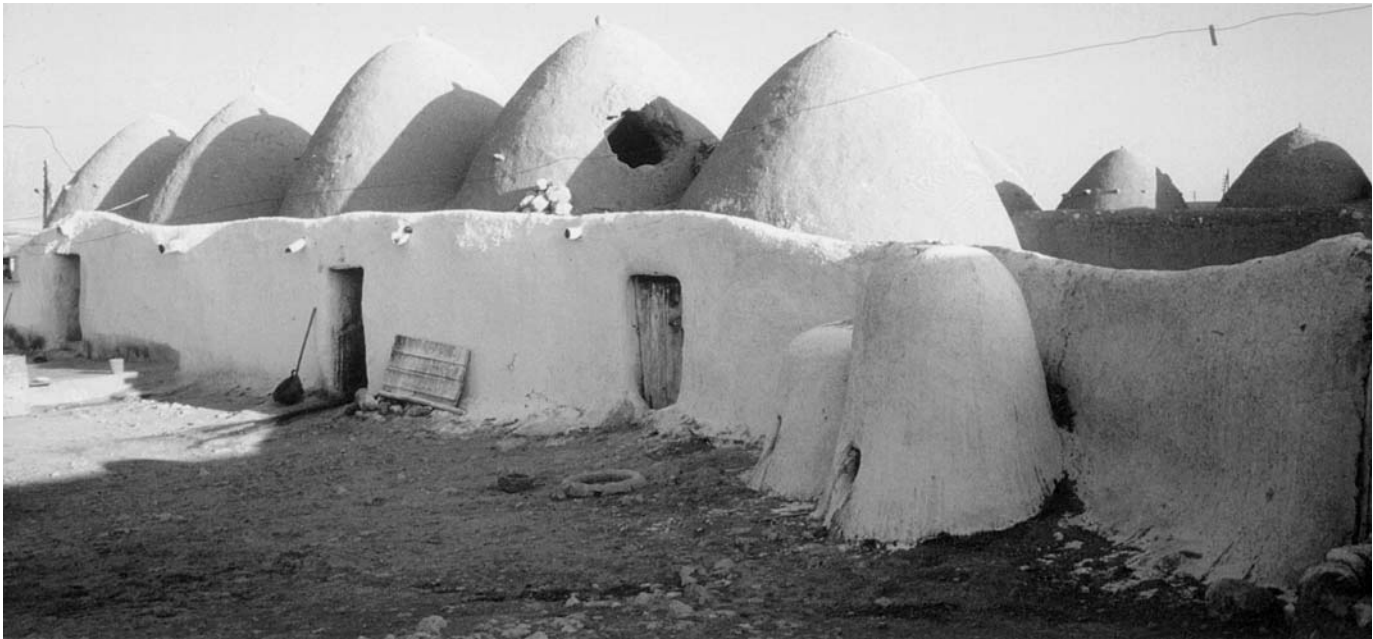

14.29

Earth block vaults and domes

Vaults and domes covering interior spaces and made from earthen blocks are found mainly in religious buildings in Europe. In southern Europe, Asia and Africa, nonetheless, they have also been used in residences, offices and public buildings (see 1.1, 1.2, 14.29 and 14.30).

These structures demonstrate several advantages in hot and dry climates, especially in areas with a wide range of diurnal temperatures. Given their inherent thermal mass

and their greater heights at the centre of a space, where light, warm air gathers and can be easily discharged through openings, vaulted spaces provide better natural climatic control than standard cubic ones. They have smaller surface areas than cubic rooms of the same volume, and therefore less heat gain.

In cold and moderate climates as well, vaults and domes have several advantages. As the surface area is smaller for the same volume, heat loss is lower, so heating energy is reduced.

In all climates, vaults and domes require less building material to enclose a given volume. In all developing countries, vaults and domes are usually cheaper in comparison with flat or slightly inclined roofs. Observation has shown that rooms with vaults and domes have a pleasing and calming effect on inhabitants in contrast to rooms with flat ceilings.

Until recently vaults and domes of loam have been built only with adobes – with the exception of two experimental domes: the rammed earth dome described in chapter 5, p. 59, and a *stranglehm* dome built at the BRL in 1985. In numerous arid regions, where timber is unavailable as a building material, techniques were developed to construct vaults and domes from air-sea-

14.30



soned adobes without structural beams, and even without formworks. These techniques are described in the following sections.

On the geometry of vaults and domes

Vaults and domes are two-dimensional curved structural elements that serve to cover interior spaces. Shell structures with the same geometry display very different structural behaviours. They are able to transfer bending moments to their supports. However, masonry vaults and domes only transfer loads under compression. If singly curved, they are called vaults (14.31, left); if doubly curved, they are called domes (14.31, right). Vaults and domes can be built from a variety of basic geometrical elements. Illustration 14.32 shows two cross vaults (A, B) and two domical vaults (C, D); all forms are composed from the parts of a barrel vault. With domes that form surfaces of revolution, that is to say, whose forms originate from the rotation of a curve around a vertical axis (usually a circular arc), and which are set above square rooms, the geometrical problem resides in the need to discover a transition from the circular geometry of the dome to the square geometry of the room. Illustration 14.33 shows four different systems for solving this problem. Solution A is a truncated dome whose bottom circle is drawn around the square, and vertical truncating planes meet the dome surface to form arches. Solution B is called a dome on pendentives. Here, a hemispherical dome rests on the lower part of a truncated dome. The doubly curved triangular surfaces are called pendentives. Solution C shows a squinch dome whose lower circle is inscribed on the square and the interconnecting surfaces, called squinches, are composed of a series of arches of increasing radius. This solution can also be described as a truncated dome resting on the inscribed diagonal square with the surfaces thus left (triangular in plan) being the squinches. Solution D is a partial squinch dome whose bottom circle is drawn around the largest regular octagon that fits the square, forming

truncated planes on four of the sides and squinches on the other four. Solution E shows a totally different way of solving this problem and can be called a bell-shaped dome. Here, we have a continuously changing double curvature beginning at the edges with an anticlastic (saddle-shaped) curvature (i.e., a curvature that is convex in one direction and concave in the perpendicular direction) and continuing to the apex with a syndastic (dome-shaped) curvature (i.e., one that is similarly curved in both directions).

Structural behaviour

Structurally speaking, vaults and domes are curved surfaces that transfer almost exclusively compressive forces to their supports. They are usually constructed of baked bricks

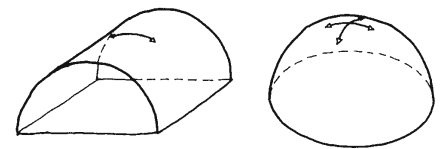

14.31

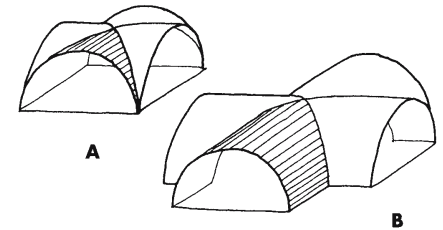

14.32

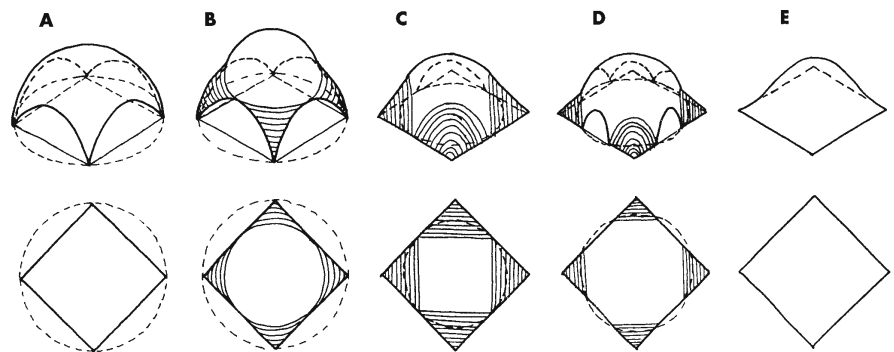

14.33

or flat stones, with joints set perpendicular to the surface of the dome, so that the courses form a radial pattern as in 14.34 top. If the courses are set horizontally, so that the masonry blocks create overhangs within, (cf. 14.34 bottom), then we speak of a "false" vault or dome. In such cases, since each course is cantilevered over the one before, the blocks are subjected to bending forces. One example of a false dome is shown in the model illustrated in 14.35 and 14.36.

The main problem in constructing vaults is how to transfer of the outward thrust force at the bottom to the supports and foundations. Illustration 14.37 shows how the resultant forces at the support can be separated into vertical and horizontal compo-

- 14.31 Vault and dome
- 14.32 Shapes created by intersecting vaults
- 14.33 Types of domes over square plans
- 14.34 "True" and "false" vaults
- 14.35 to 14.36 Model of a building with "false" vaults
- 14.37 Separation of forces at the support
- 14.38 Deflection of the resultant shear force into the foundation



14.35



14.36

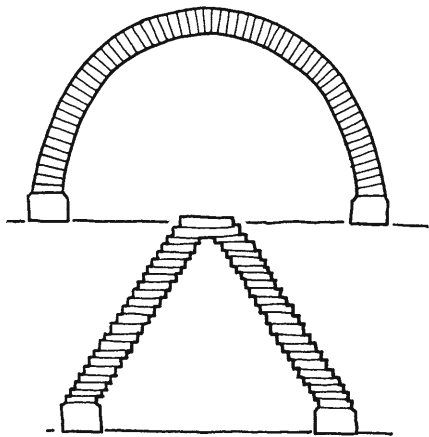

14.34

nents. The steeper the forces are conducted into the foundation, the smaller are the horizontal forces, and the easier the formation of foundation. A rule of thumb is that the forces resulting from vault thrust and wall loads must fall within the middle third of the pedestal and foundation bases. This means that eccentricity should be no more than $\frac{1}{6}$ of the breadth (14.38). Since this consideration can mean a very large and, hence expensive foundation, it may prove expedient to plan for additional structural measures, such as those shown in 14.39. In solution A, for example, the inclination of the resulting load is reduced by means of superimposed loads. A second simple solution, shown in B, consists of buttresses. In this case, to prevent excessive

bending stress, spacings between buttresses should not be too large. A structurally superior variation is shown in C, with buttresses connected by arches. Solution D shows the transfer of the resultant horizontal thrust to tensile structural elements in the floor (reinforced concrete plates, for example), which neutralise the thrust so that only vertical forces are transferred to the foundation. Solution E shows single tensile ties which act in the same way. They are placed above the walls supporting the vault. In this case, ring or peripheral beams have to be provided, which can take the bending forces that occur between the tie ends. Solutions F and G show two different ways of diverting the thrust of the central dome to low lateral vaults.

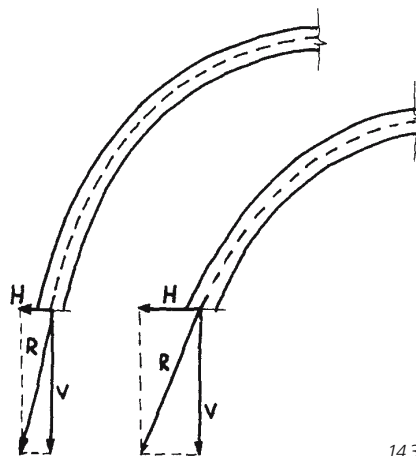

14.37

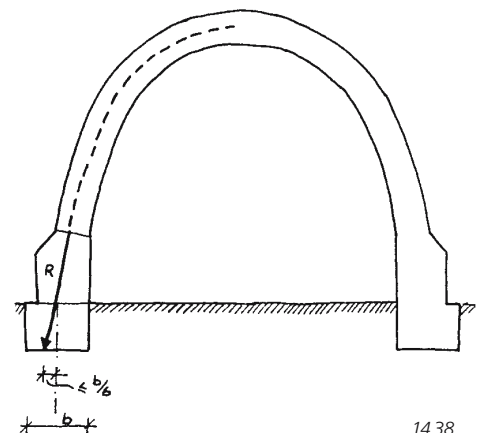

14.38

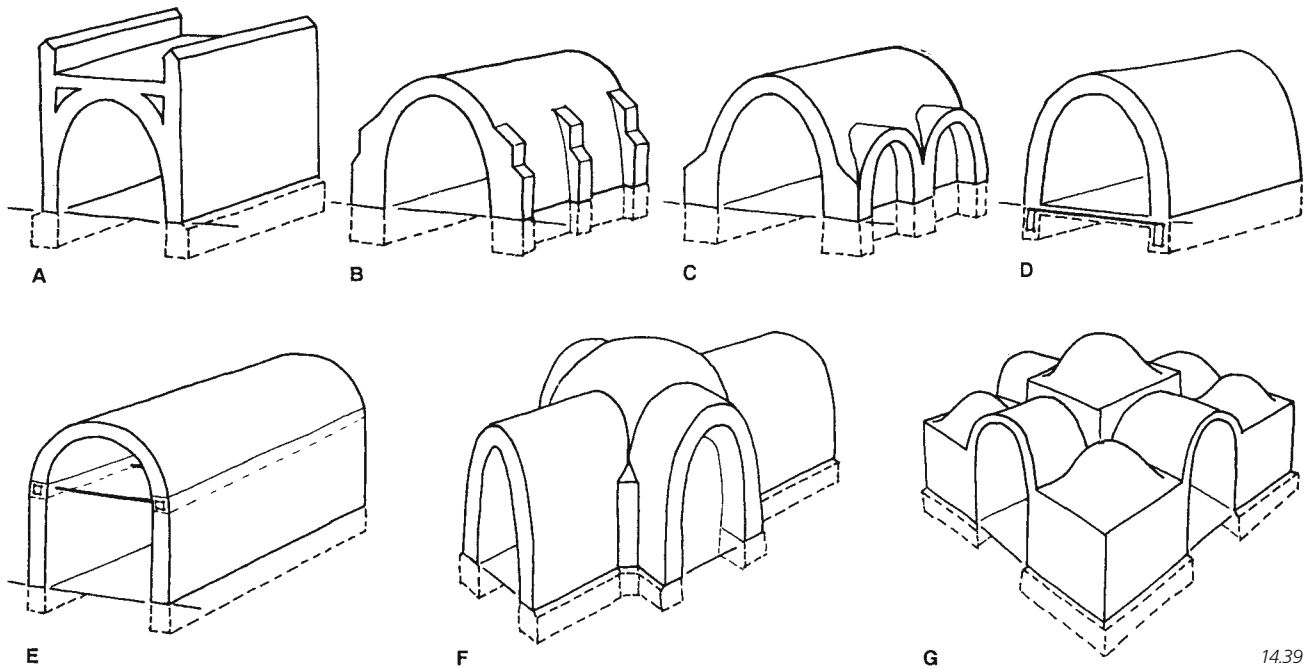

14.39

If two identical barrels converge in one strip foundation, then the horizontal components of the resultant thrust are neutralised (see 14.40 right). If, on the other hand, the barrels have different shapes, then only a portion of this horizontal thrust will be neutralised (14.40 left).

Since adobe vaults can endure only very small tensile forces, it is important to design them so that, as nearly as possible, only compressive forces occur. With a barrel vault that bears only its own weight, this is the case if its cross-section is an inverted catenary curve, defined as the shape assumed by a freely hanging chain, which is subjected only to tractive force. When inverted, this curve represents the ideal supporting line (line of thrust) for a vault in which only compressive forces occur under dead load (14.41). This line can be computed by the catenary formula $y = a \cosh(x/a)$, and can be defined by the position of the two points of support and the apex (see 14.42). In a semicircular vault, the line of support does not run in the centre of the wall thickness. It might even fall outside the structure, as shown in 14.43 A. This causes bending stresses and usually leads to failure. If the thickness of the vault is large enough to

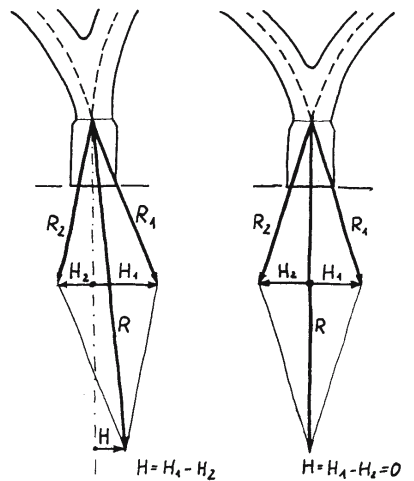

14.40

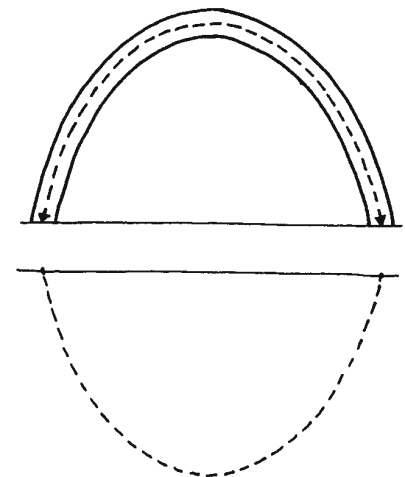

14.41

contain the line of thrust within its middle third (14.43 B), then this danger is avoided. The ideal cross-section of a dome under dead load is that which only creates compressive forces going downwards (meridional). This means a form that creates neither tensile nor compressive ring forces. If the cross-section has the shape of a catenary, then compressive ring forces will occur. This might be disadvantageous if openings have to be cut into the dome, or if it is a dome of large span. To work out the ideal shape of a vault, a slice as shown in 14.44, left, is taken out

- 14.39 Possibilities of structural stabilisation
- 14.40 Horizontal forces
- 14.41 Reversed catenary
- 14.42 Catenaries of same length
- 14.43 Lines of support
- 14.44 to 14.45 Simulation of loads
- 14.46 Calculation of surface areas

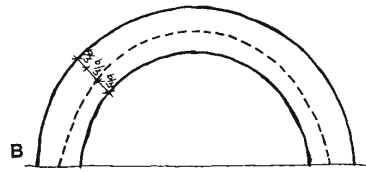
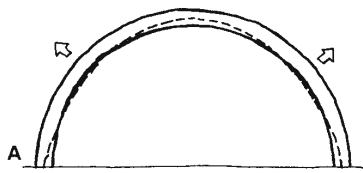

14.43

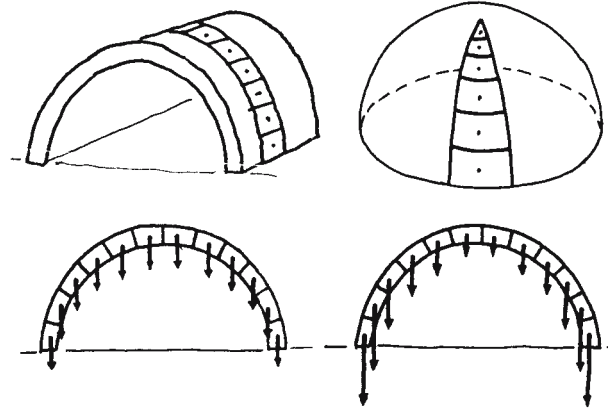

14.44

and divided into segments of equal length. This gives segments of identical area and, therefore, can be substituted by single loads of equal magnitude acting at the centre of each segment. However, in the case of a dome, if we take a slice, as shown in the figure on the right, and divide this into segments of equal length, the widths and, therefore, the areas are continuously decreasing from the base to the apex. If these segments are substituted by single loads, then their loads are also thereby proportionally decreased. If the ideal form is to be derived from a model, then, corresponding loads can be added to a chain which then forms this ideal curve, as seen in 14.45.

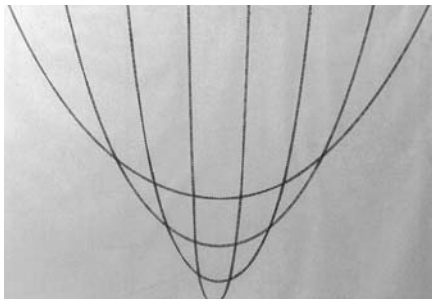

14.42



14.45

Here, this ideal curve is shown in contrast to a catenary. In 14.46, formulas are given for calculating areas of the segments of a sphere. However, since the ideal form is not spherical, its segments have an area slightly differing from the one that we started from. Therefore, this procedure has to be considered a first approximation, which is in practice sufficiently accurate for smaller spans. Greater accuracy can be achieved by successive iterations, substituting the actual changing radii of curvature of the segments measured from the model and adjusting the loads according to the surface areas of the segments thus calculated.

The first assumption (that the dome is a hemisphere) cannot be used if the height is not equal to the half-span. In this case, one should start from the shape of an ellipse

whose axis is below the base of the dome. This starting assumption is already close to the ideal form, which can then be refined by the model.

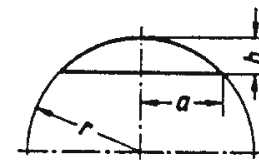

$$\text{Vault } M = 2\pi r h \\ = \pi (a^2 + h^2)$$

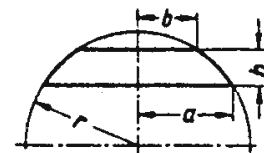

$$M = 2\pi r h$$

$$r = \sqrt{a^2 + \left(\frac{a^2 - b^2 - h^2}{2h}\right)^2}$$

14.46

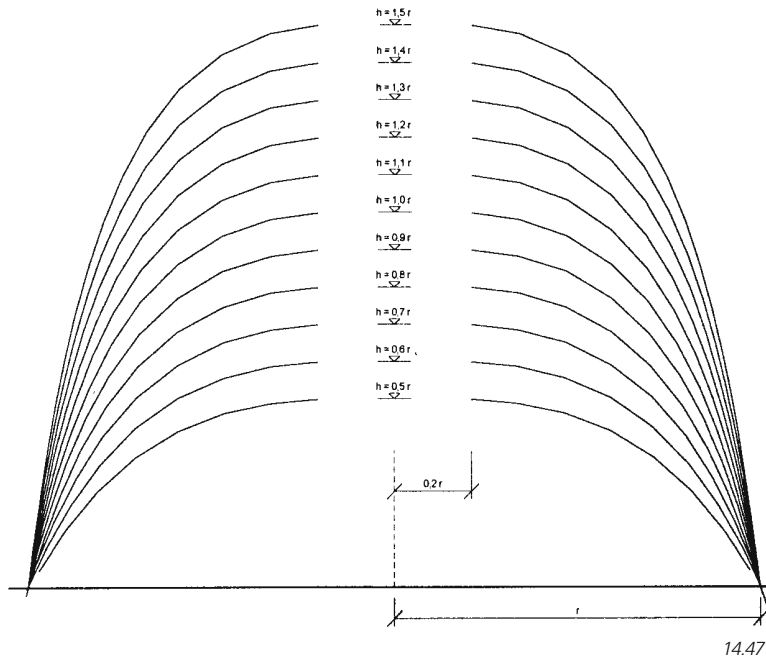

14.47 Optimised cross-sections with different $h:r$ ratios

14.48 Cross-sections

14.49 Nubian vault

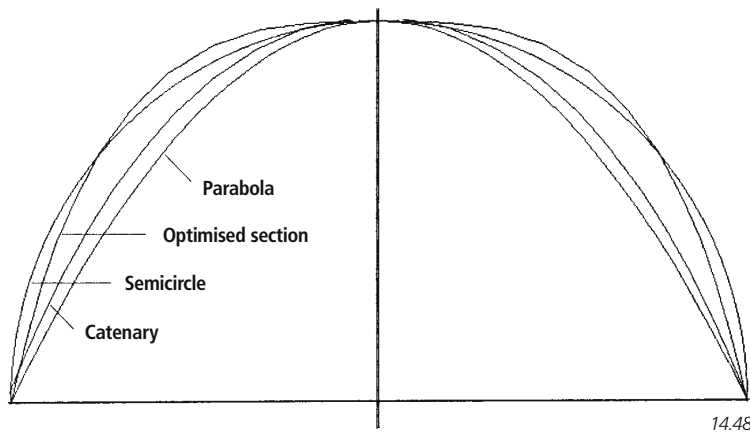





A more exact method to derive ideal curve is by graphic methods used in statics engineering. At the BRL, these methods were used to develop a computer programme. Some results for eleven different dome proportions from $h = 1.5 r$ to $h = 0.5 r$ (where h is the height and r the half-span) are plotted in 14.47. In each case, a skylight opening of $0.2 r$ was taken into account. Illustration 14.48 shows the ideal curve in comparison with a parabola, catenary and semicircle.

In the section of the dome is inside the ideal curve, as happens with the catenary, compressive ring forces are created. If it is outside, tensile ring forces will occur, as with the lower part of a hemispherical dome.

Tensile ring forces usually lead to failure. Compressive ring forces usually do not create problems, except when interrupted by large openings.

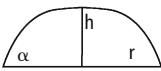
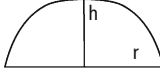
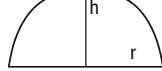
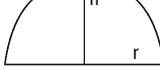
Table 14.51 gives the coordinates of the ideal line of support for seven different dome proportions, from $h = 0.8 r$ to $h = 1.4 r$ (where h is the height and r the half-span), without taking into account any openings at the apex.

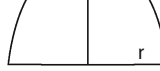
To take into account asymmetric loads which might occur in practice due to wind, maintenance etc., and to conservatively ensure that no tensile ring forces occur, it is better to keep the section inside the ideal curve, especially in the upper part.

Nr.	y	x	y	x	y	x	y	x	y	x	y	x	y	x
1	0.0000	1.0000	0.0000	1.0000	0.0000	1.0000	0.0000	1.0000	0.0000	1.0000	0.0000	1.0000	0.0000	1.0000
2	0.0452	0.9854	0.0454	0.9875	0.0479	0.9885	0.0470	0.9902	0.0422	0.9912	0.0494	0.9918	0.0469	0.9929
3	0.0973	0.9674	0.0982	0.9720	0.1013	0.9750	0.1007	0.9783	0.1016	0.9807	0.1036	0.9823	0.1013	0.9844
4	0.1489	0.9483	0.1508	0.9556	0.1544	0.9608	0.1543	0.9658	0.1555	0.9696	0.1578	0.9724	0.1556	0.9755
5	0.2001	0.9279	0.2030	0.9381	0.2073	0.9456	0.2077	0.9526	0.2093	0.9579	0.2118	0.9620	0.2098	0.9662
6	0.2506	0.9061	0.2548	0.9195	0.2600	0.9295	0.2610	0.9386	0.2629	0.9456	0.2657	0.9511	0.2640	0.9565
7	0.3005	0.8827	0.3061	0.8996	0.3123	0.9124	0.3139	0.9237	0.3164	0.9326	0.3195	0.9396	0.3180	0.9462
8	0.3495	0.8575	0.3569	0.8782	0.3642	0.8940	0.3667	0.9079	0.3697	0.9188	0.3732	0.9274	0.3720	0.9354
9	0.3974	0.8303	0.4069	0.8552	0.4156	0.8744	0.4191	0.8911	0.4227	0.9041	0.4267	0.9145	0.4258	0.9241
10	0.4441	0.8011	0.4562	0.8305	0.4665	0.8533	0.4711	0.8730	0.4755	0.8885	0.4800	0.9008	0.4795	0.9121
11	0.4893	0.7695	0.5043	0.8038	0.5167	0.8306	0.5226	0.8536	0.5280	0.8718	0.5331	0.8863	0.5331	0.8993
12	0.5327	0.7355	0.5513	0.7749	0.5660	0.8060	0.5736	0.8328	0.5800	0.8540	0.5859	0.8708	0.5864	0.8858
13	0.5738	0.6987	0.5967	0.7436	0.6143	0.7795	0.6239	0.8103	0.6316	0.8347	0.6384	0.8542	0.6396	0.8714
14	0.6124	0.6592	0.6402	0.7097	0.6613	0.7507	0.6733	0.7860	0.6827	0.8140	0.6905	0.8364	0.6924	0.8561
15	0.6479	0.6170	0.6815	0.6731	0.7067	0.7194	0.7217	0.7596	0.7330	0.7917	0.7422	0.8173	0.7450	0.8397
16	0.6799	0.5721	0.7200	0.6337	0.7502	0.6855	0.7688	0.7309	0.7825	0.7674	0.7932	0.7966	0.7971	0.8220
17	0.7081	0.5246	0.7554	0.5913	0.7913	0.6487	0.8143	0.6998	0.8309	0.7411	0.8436	0.7743	0.8488	0.8030
18	0.7322	0.4750	0.7872	0.5462	0.8296	0.6090	0.8578	0.6658	0.8780	0.7124	0.8930	0.7500	0.8999	0.7825
19	0.7522	0.4235	0.8149	0.4984	0.8646	0.5663	0.8988	0.6290	0.9234	0.6811	0.9414	0.7235	0.9503	0.7602
20	0.7680	0.3707	0.8384	0.4485	0.8957	0.5207	0.9369	0.5891	0.9667	0.6470	0.9883	0.6947	0.9998	0.7360
21	0.7801	0.3168	0.8576	0.3967	0.9227	0.4725	0.9716	0.5461	1.0076	0.6099	1.0336	0.6632	1.0482	0.7096
22	0.7887	0.2624	0.8725	0.3436	0.9452	0.4221	1.0023	0.5002	1.0453	0.5696	1.0767	0.6287	1.0951	0.6807
23	0.7944	0.2076	0.8836	0.2896	0.9633	0.3700	1.0286	0.4517	1.0795	0.5262	1.1172	0.5912	1.1403	0.6491
24	0.7978	0.1526	0.8912	0.2350	0.9771	0.3165	1.0504	0.4009	1.1095	0.4799	1.1544	0.5505	1.1830	0.6145
25	0.7994	0.0975	0.8961	0.1801	0.9870	0.2623	1.0675	0.3485	1.1350	0.4309	1.1879	0.5065	1.2236	0.5768
26	0.8000	0.0425	0.8987	0.1251	0.9936	0.2075	1.0804	0.2948	1.1557	0.3798	1.2170	0.4596	1.2606	0.5358
27	0.8000	0.0000	0.8998	0.0700	0.9974	0.1526	1.0894	0.2404	1.1719	0.3270	1.2415	0.4101	1.2933	0.4915
28			0.9000	0.0000	0.9993	0.0975	1.0951	0.1856	1.1836	0.2731	1.2611	0.3585	1.3222	0.4443
29					0.9999	0.0425	1.0983	0.1306	1.1916	0.2185	1.2761	0.3054	1.3459	0.3944
30					1.0000	0.0000	1.0997	0.0755	1.1965	0.1636	1.2867	0.2513	1.3648	0.3425
31							1.1000	0.0205	1.1990	0.1086	1.2936	0.1966	1.3789	0.2892
32							1.1000	0.0000	1.1999	0.0535	1.2976	0.1416	1.3887	0.2349
33									1.2000	0.0000	1.2995	0.0865	1.3949	0.1801
34											1.3000	0.0315	1.3983	0.1251
35											1.3000	0.0000	1.3997	0.0700
36													1.4000	0.0150
37													1.4000	0.0000
														
	$h = 0.8 r$	$h = 0.9 r$	$h = 1.0 r$	$h = 1.1 r$	$h = 1.2 r$	$h = 1.3 r$	$h = 1.4 r$							
α	72.6	75.0	76.9	78.5	79.7	80.7	81.6							
A	$5.3374 r^2$	$5.7789 r^2$	$6.2195 r^2$	$6.6941 r^2$	$7.1685 r^2$	$7.6426 r^2$	$8.1514 r^2$							
V	$16.1064 r^3$	$18.2911 r^3$	$20.4262 r^3$	$22.6921 r^3$	$24.9307 r^3$	$27.1455 r^3$	$29.5145 r^3$							



14.52



14.53

Nubian vaults

With the Nubian vault technique, used for centuries in Upper Egypt, vaults can be built without any formwork by using reclining arches made of adobe. Illustration 14.49 shows such a vault, which is 3200 years old and stands within the temple precincts of Ramses II near Luxor. Such vaults are commonly constructed of adobes measuring 15 cm in width, 25 cm in length and only 5 to 6 cm in thickness. This means that the weight of each brick per unit area of mortar joint is very low, which prevents adobes in inclined positions from sliding during construction. The degree of inclination of the arches is a decisive factor in the construction process. This should be between 65° to 70° with the horizontal. As tests have shown, if the arches are built up at a lower angle, the lower part of the vault might collapse during

construction, while if the angle is larger, the adobes might slide off the top.

Nubian vaults need one or two vertical walls onto which the inclined arches lean (14.50 A and B). It is also possible to lean the arches against a central “supporting arch,” which typically has the section of the vault and has to be made with shuttering (14.50 C and 14.52). The cross-section of the Nubian vault, which is mainly loaded by its own weight, should have the form of an inverted catenary, so that it contains only compressive stresses.

At the BRL this traditional technique was refined in two ways: first, instead of using rectangular formats, a square block measuring 20 x 20 cm, 6 cm thick was used for the lower part of the vault, and tapered versions of these blocks were used in the upper part of the vault, with the lower part shortened by 1.5 cm. This reduced labour input and the quantity of mortar required. It was found that by using an optimum mortar composition with high binding force, it is also possible to use adobes with thicknesses of up to 10 cm. This leads to further savings in mortar and time.

Second, the shape of the vault was controlled during construction by stretching a cord from one support wall to the next (or to the corresponding scaffolding). It is essential that this cord passes through an eyelet on one end and is held taut by a weight. When deformed by lateral pressure, the cord will be immediately restored by the moving weight to the correct position. When building the reclining arches, it is advisable that the blocks forming the arch are held together by keeping them touching on the inner edge with hardly any mortar in between, and wedging with a stone chip on the outer edge if required, so as to display arch action even before the mortar is dry (14.53).

14.50 Nubian vaults with support walls and support arch (side elevations)
14.51 Coordinates of structurally optimised domes
14.52 to 14.53 Construction of a Nubian vault with support arch

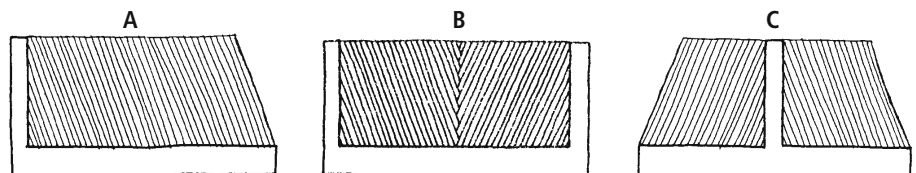

14.50

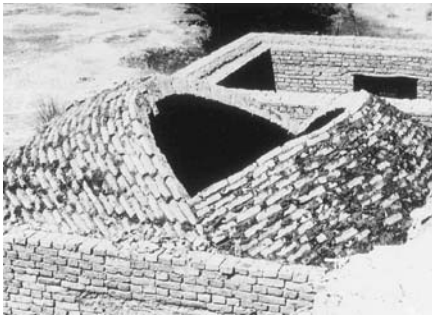

14.54



14.55



14.56

14.54 to 14.56 Construction of an Afghan dome
14.57 to 14.48 Model of dome shape deriving from the Nubian and Afghan techniques (BRL)

Afghan and Persian domes

In Afghanistan, a technique for building domes without formwork has been used for centuries. With this technique, bell-shaped flat domes are produced to cover square rooms by constructing reclining arches which are set at angles of ca. 30° to the horizontal. Illustrations 14.54, 14.55 and 14.56 show the construction process of a dome (over a 4 x 4 m room), which can be built in half a day by five to six people. With this technique, the adobe blocks forming the arch should touch at their lower edges, and wedges should be inserted into the upper gaps (see 14.56). Since this

method allows the arch action to come into effect before the mortar has dried, labourers can even stand on the dome while it is under construction.

Different models were built at the BRL in order to show that a wide variety of architectural forms can be covered with this technique, and that it can also be combined with the Nubian dome technique (14.57 to 14.60).

In 14.61 a variation of the Afghan dome technique is shown. In former times this was often used in Persia and is therefore called the Persian dome technique. Here, reclining arches are started from all four corners of the base. In this example vaulted wind catchers have been integrated into the dome.



14.58

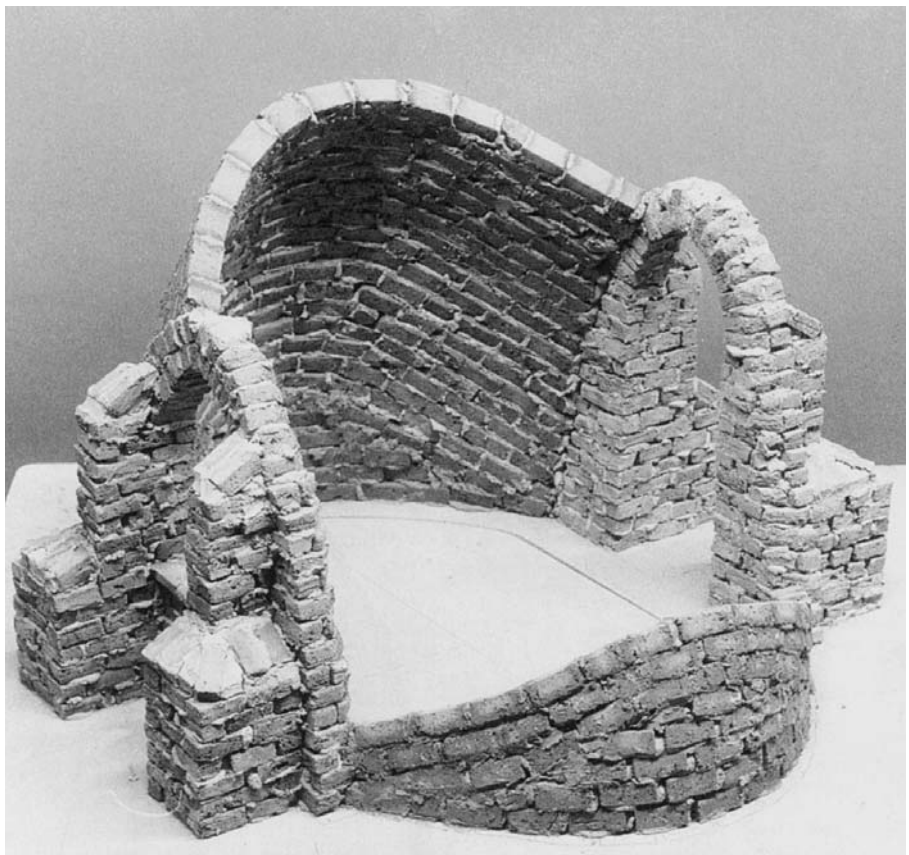

14.57

Nubian domes

The Nubian dome technique has been known in Upper Egypt for thousands of years. In this technique, circumferential courses of adobes are laid using a movable guide (14.62).

With this technique, blocks are turned on edge. This avoids slippage of the freshly laid blocks. However, this requires that special wedge-shaped blocks be used periodically (14.63). Due to the high labour input required most domes were built without turning the blocks, that is, placing them in radially.

The main disadvantage of the Nubian domes technique is that only spherical domes can be produced. As explained in this chapter, p. 116, in spherical domes, tensile ring forces occur in the bottom portions. Therefore, when covering larger

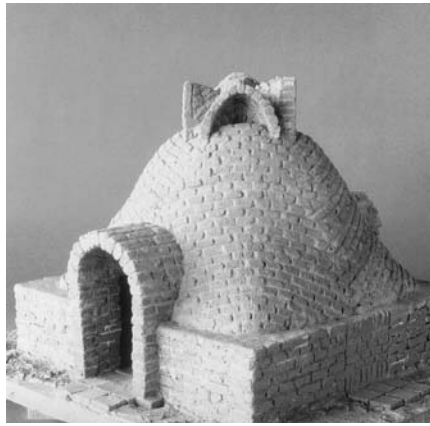

14.61

spans, steel strips or reinforced concrete ring beams or other strengthening elements have to be additionally applied. If this is not considered, domes might fail, as has happened in practice.

The group Development Workshop, Lauserte, France, built several residences, offices and public buildings in Niger using a modified version of this technique, shown in 14.64. Here, instead of the centrally mounted rotating guide, an eccentric rotating guide is used. By this, the shape generated can be such that the tensile ring forces in the lower part are avoided. However, compressive ring forces thus created might cause problems if larger openings are made for entrances or windows.



14.59

14.59 to 14.60 Models of different dome shapes deriving from the Nubian and Afghan techniques (BRL)

14.61 Persian dome with wind catchers

14.62 to 14.63 Nubian dome (CRATerre, 1979)

14.64 Modification of Nubian dome with eccentric guide

14.65 to 14.68 Prototype dome (BRL)

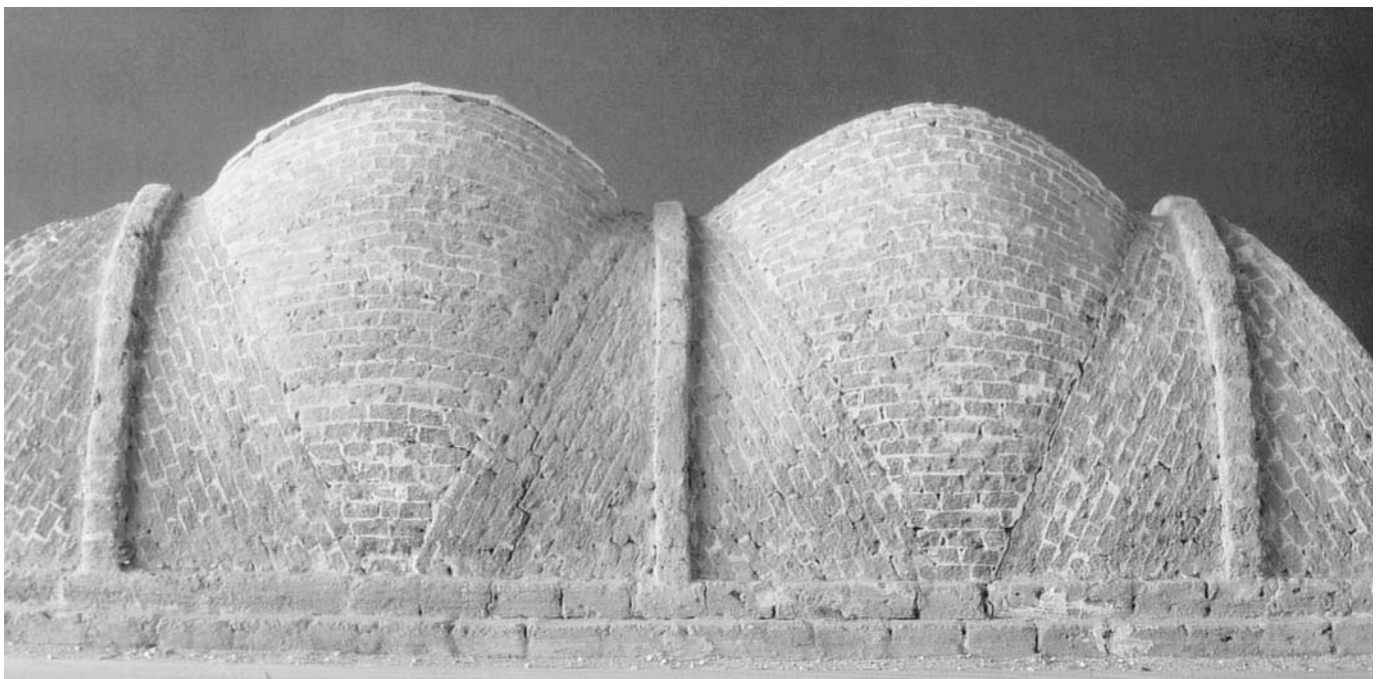

14.60

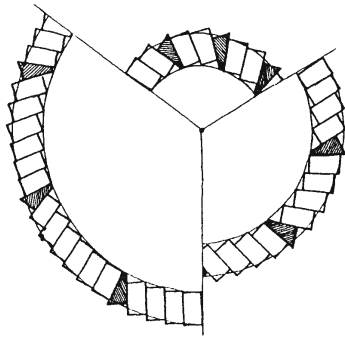

14.63

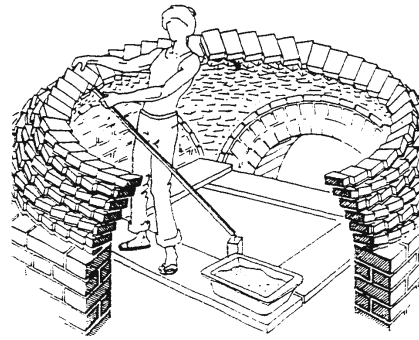

14.62

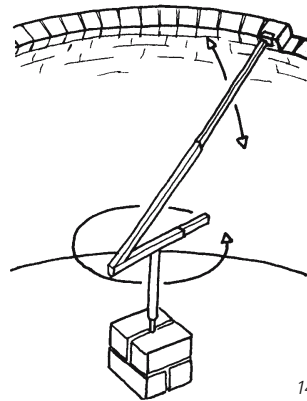
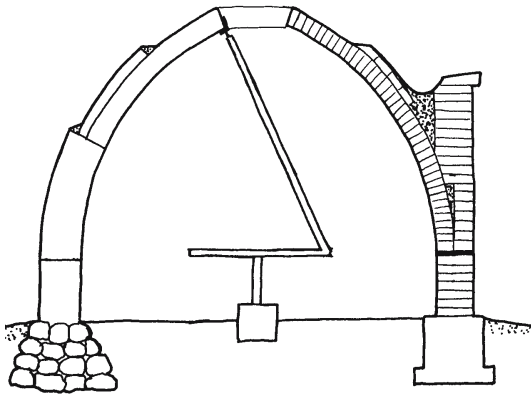

14.64

Structurally optimised domes

In order to avoid the disadvantages of Nubian dome technology, a new technique for making domes using a rotational guide was developed at the BRL. With this technique, the structurally optimal geometry of the dome can be achieved without formwork. This geometry avoids all tensile ring forces as well as compressive ring forces. The derivation of this shape is described on p. 116 of this chapter.

The rotational guide has a right-angled head into which the blocks are placed. This angle can be moved on a curved metal T-section bent to shape. This T-section is fixed to a rotating arm, which is in turn fixed to a vertical post. Illustrations 14.65 to 14.68 show the application of this technique to a dome with a 7 m free span and 6 m of clear height, which was built at the University of Kassel in Germany in 1992. The apex is covered with a 16-sided pyramidal sky-



14.66



14.65



14.67

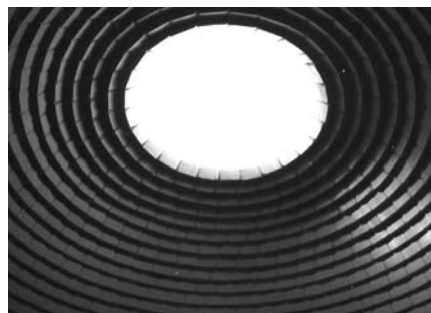

14.68

light. The thickness of the dome wall is only 20 cm and the cross-section was derived using a computer program in order to get the optimum shape with no ring forces, as described on p. 116 of this chapter. In order to prevent the blocks of the upper layers from sliding while under construction, the courses are not exactly perpendicular to the surface of the dome, but are slightly



14.72

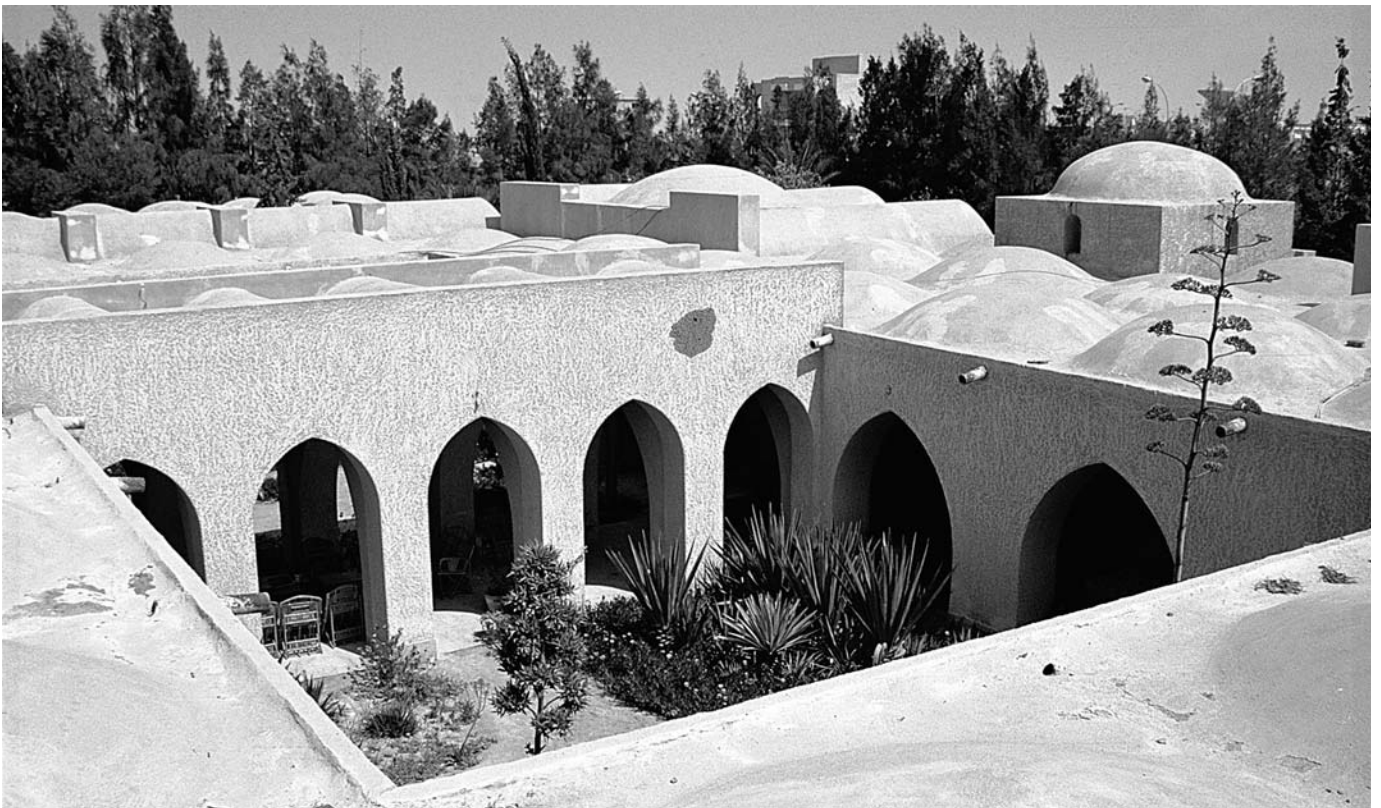

14.73



14.74



14.75



14.69



14.70

less inclined so that the top layer has 20° less inclination and a partial corbelling effect can be seen. This, furthermore, has the advantage that no sound-focusing effect occurs (see 14.68). The blocks used were tapered and extruded through a special snout in a mechanical brick plant.

Domes and vaults on formwork

It is very labour- and material-intensive to build formworks for domes, which is why nearly all historical dome construction techniques avoided it. An exception is the shallow Catalan dome (sometimes called a “funicular shell” in India), which is essentially a bell-shaped dome that can cover triangular, square, rectangular or other shaped bases. Timber boards, steel sheets and glass-fibre reinforced polyester elements have been used for the formwork. It is, however, much easier to make a formwork with moist sand, as shown in 14.70. When constructing vaults, it is much easier to build a formwork, as these only have singly curved surfaces. Furthermore, only a short piece of formwork can be used and shifted as the vault construction proceeds. This technique is normally used to construct jack vaults (see 14.14). The jack vault shown in 14.69 was built on a sparse formwork, erected on thin laths positioned underneath the joints of the earth blocks. These blocks were arranged without mortar. The joints were later moistened, and then mortar was filled in from above.



14.71

Firing of earthen domes

The Persian architect Nader Khalili has constructed several earthen domes in Iran and in the USA, which he attempted to strengthen subsequently by firing them from the inside. While the combination of the four elements used to create these spaces, earth, water, air and fire, may lend them a mystic touch, they yet have several disadvantages regarding climate and external environment. The burning of the logs, branches and twigs creates pollution and consumes large quantities of energy. Furthermore, the burning process cannot be fully controlled and is hence not optimum. The uneven heating of the blocks may produce cracks reducing structural stability. Also, most of the pores in the blocks are closed by burning, drastically reducing their capacity to absorb and desorb humidity (see chapter 1, p. 14). This, however, means failing to exploit the principal advantage of loam as a building material.

14.69 Jack arch with minimised formwork
 14.70 Dome, utilising moist sand as formwork
 14.71 Completed vault in a private residence in Kassel, Germany
 14.72 to 14.73 Desert Research Institute, Sadat City, Egypt
 14.74 to 14.75 Wissa Wassef Centre, Cairo, Egypt



14.76

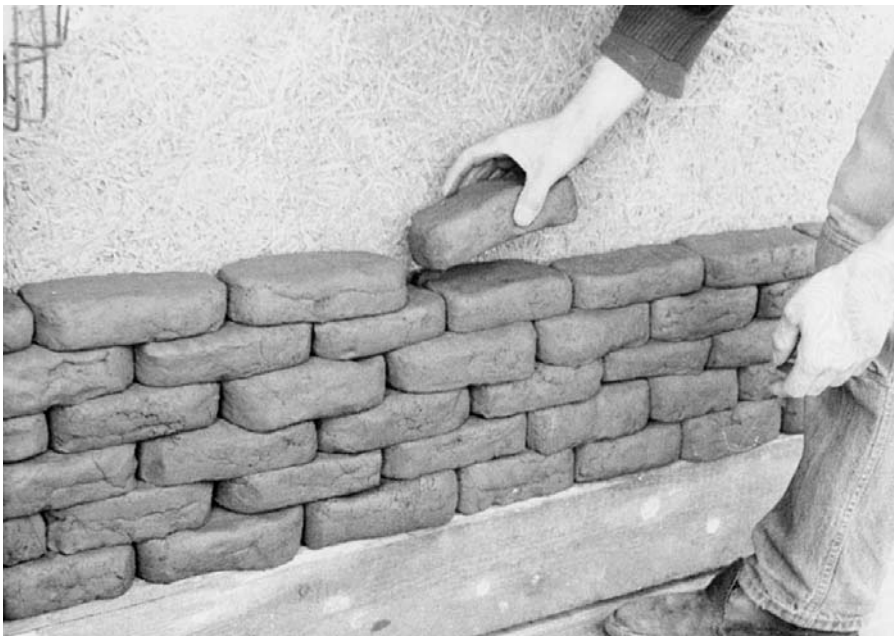

14.77

Earthen storage wall in winter gardens

In order to enhance the thermal storage and the humidity balancing effect of a winter garden with a floor area of 20 m², forming part of a residence at Kassel, Germany, a storage wall made of wet plastic loam loaves was built (14.76 and 14.77).

The loaves, measuring 20 x 14 cm, were formed by hand and stacked without mortar or filled joints, thereby effectively doubling the surface of the loam that is active in thermal storage and humidity absorption and desorption. The wall surface above the glazed opening, 14.76, was covered with thrown loam balls, as described in chapter 11, p. 95.

14.76 Heat storage wall in a winter garden

14.77 Laying loaves of loam

Loam in bathrooms

The assertion that a loam-finished bathroom is more hygienic than a tiled bathroom astonishes many. Both experiences over several years with bathrooms having loam walls and scientific investigations regarding the absorptive and desorptive behaviour of loam have, however, demonstrated this assertion.

Mirrors in a bathroom that is tiled up to the ceiling have been observed to fog up after a normal hot shower. With doors and windows closed, the mirror remains fogged up to a period of 30 to 60 minutes after the

shower. In a bathroom with loam walls, by contrast, the mirror clears under similar conditions in only 3 to 6 minutes. This is because loam walls absorb humidity from the room when its relative humidity is higher than about 50%, and release it later when the air humidity falls below about 50% (see also chapter 1, p. 14). Since humidity in bathrooms with loam walls reduces quickly, fungus growth cannot occur, whereas in tiled bathrooms, the humidity remains high over a longer period due to the sealed surfaces, allowing fungus growth in the joints of the tiles, especially joints grouted with silicone material. While



14.78



14.79

14.78 Loam wallpaper

14.79 Bathroom, private residence in Kassel, Germany

14.80 Sanitary objects covered by loam-filled hoses

14.81 Wash basin, private residence in Kassel, Germany

14.80 Bedroom, private residence in Kassel, Germany
14.81 Wash basin, private residence in Kassel, Germany



14.80



14.81

formaldehyde in the joint mixture prevents this, it should be mentioned that this chemical is carcinogenic.

Even the wall behind the shower can be of loam, as long as the shower curtain wraps around to prevent it from getting splashed, see 14.80. Illustration 14.78, shows a "loam wallpaper" over a bath tub. Old curtain fabric was dipped into clayey loam slurry and slapped onto the wall and sculpted with the fingers. This surface can easily be made water-resistant by coating it with water-repellents, double-boiled linseed oil, water-glass or other paints and coatings.

Built-in furniture and sanitary objects from loam

As already indicated, the plasticity of loam allows not only for the building of exterior walls, ceilings and floors but also of built-in furniture. For this, loam elements when still wet are particularly suitable as they can be given a great variety of shapes; they also open up new aesthetic possibilities. The bedroom wall shown in 14.80 is both an external wall and a built-in closet. It is built from *stranglehm* elements (see chapter 8, p. 77). The side partition walls of the wardrobe also buttress the exterior wall. The bamboo rod, built in during construc-

tion, acts as a hanger rod, and also stiffens the side partition walls. On another external wall of this bedroom, shown in 8.25, p. 77, niches and ledges for storing personal effects were carved out of the *stranglehm* wall.

Shelves can be easily fixed between *stranglehm* walls (see chapter 8, p. 77) or lightweight loam-filled hoses (see chapter 10, p. 90). Illustration 14.79 shows such shelves and a mirror integrated into the wall.

Illustration 14.82 shows a bathroom whose central shower, adjacent planter and bath tab are covered by loam-filled hoses.

Even washbasins can be built from unbaked loam. The example shown in 14.81 is made of a special sandy loam with high binding force, in which shrinkage cracks were totally avoided. To this mixture 6% double-boiled linseed oil was added. After drying, the basin was coated with a layer of linseed oil. The example in 14.79 was used for fourteen years without signs of deterioration. In both cases, trap and drain fittings were mounted in a small ceramic bowl, around which the loam was arranged. It is sculpted of unbaked loam stabilised by 6% of casein-lime glue. Both washbasins proved to be waterproof.

Wall heating systems

In cool and cold climates where heating systems are necessary, wall heating systems integrated into earth walls are a preferable solution. They enjoy many advantages in comparison with traditional systems. The heat is radiated, which avoids unhealthy air movement and dust circulation. Wall systems are more economical, easier to repair and less inert than floor systems. The easiest way to build a wall radiation system is to fix plastic or copper tubes on the existing wall and to cover them with mud plaster, using warm or hot water for heat transfer.



14.82

Passive solar wall heating system

A residence cum office in Kassel, Germany, has an effective heating system that runs exclusively on solar energy (see p. 153). The solar energy is conducted through a 10-cm-thick insulating layer of thin polycarbonate tubes to reach a 24-cm-thick loam wall that is covered with loam plaster. The plaster is coated with a thin, absorptive black paint. This wall radiates the heat into the interior of the house. In summer, when no heating is required, the translucent slab is covered by a reflective curtain (sunshade) (14.83).

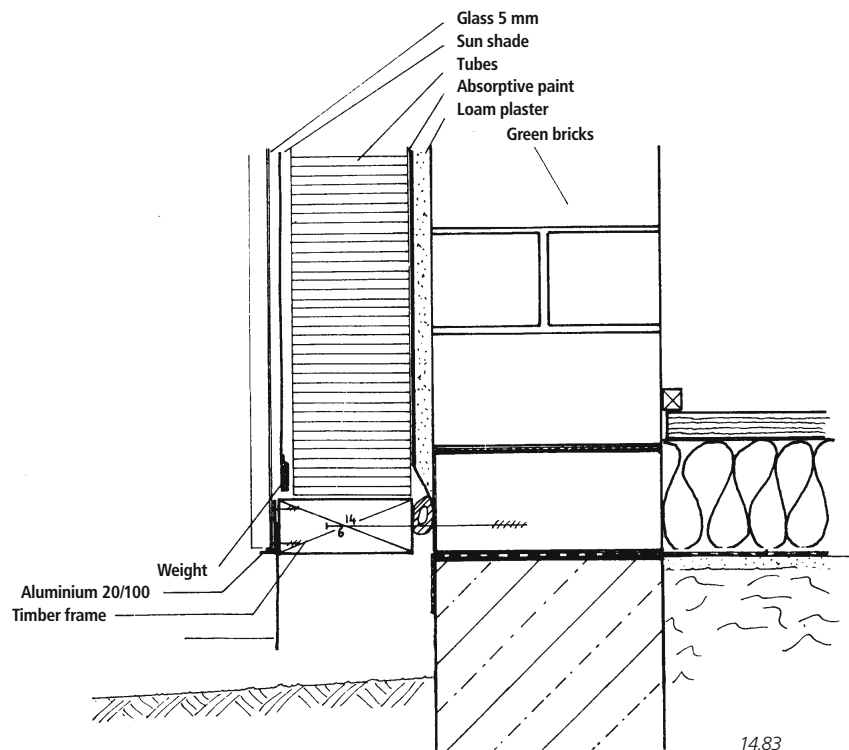

14.82 Bathroom, private residence in Kassel, Germany

14.83 Loam wall with translucent thermal insulation slab, acting as passive solar heating system

15 Earthquake-resistant building



15.1 Condominium of the Hakkas, China

15.1

Earth as a building material has lost its credibility chiefly because most modern houses with earth walls cannot withstand earthquakes, and because earth is viewed a building material for the poor. In this context, it is worth mentioning that a census conducted by the Salvadoran government after the earthquake of January 13, 2001 (measuring 7.6 on the Richter scale), states that adobes houses were not worse affected than other types of construction. On the other hand, many historical earth buildings have withstood several strong earthquakes in recent centuries, for example the condominiums of the Hakas in China (15.1) and many solid rammed earth fincas in Argentina. But also houses with light-weight roofs and flexible wattle-and-daub

walls – like the Guatemalan house in 15.2 – can withstand earthquake shocks because of their ductility (flexibility).

The quality of an earthquake-resistant structure can be expressed in the formula

$$\text{structural quality} = \text{resistance} \times \text{ductility}$$

This means that the lower the resistance of a given structure, the higher its flexibility must be, while the higher its flexibility, the lower the required resistance.

It is not earth as a building material which is responsible for structural failures, but instead the structural system of a given building and the layout of its openings, as discussed in the following sections.

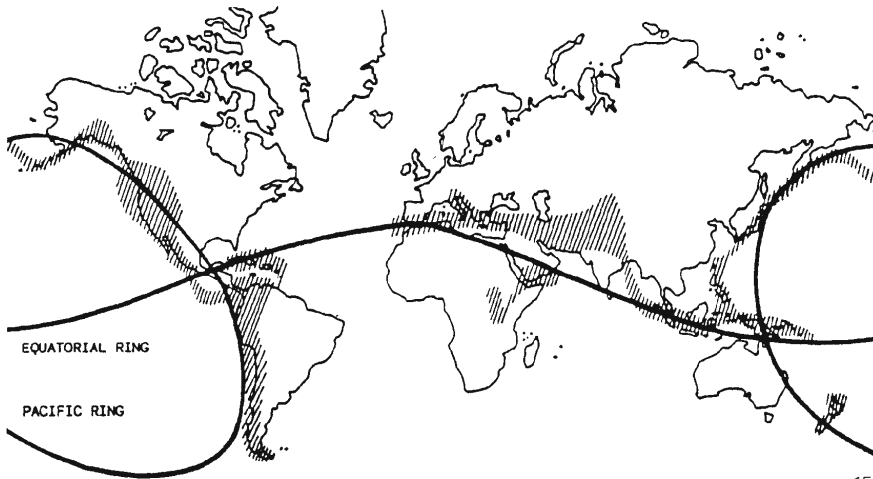

15.3

Earthquakes are caused by the movements of tectonic plates or by volcanic activity. The world's most earthquake-prone regions are shown in 15.3. In Asia, earthquakes with intensities of 8 on the Richter scale have been recorded; in the Andes, ones measuring up to 8.7. Annually, nearly a hundred earthquakes are recorded with intensities above 6, and twenty with intensities above 7 on the Richter scale. Several thousand people are affected by earthquakes every year.

Buildings are mainly struck by the horizontal acceleration created by the movement of the earth. The vertical accelerations created by seismic activity are less than 50% of the horizontal ones.

Since loam buildings are rarely higher than two storeys, this section mainly discusses the earthquake resistance problems of these kinds of buildings.

In one- or two-storeyed buildings, the principle danger during earthquakes is that walls will fall out and roofs will come down.



15.2

Therefore, one of the main structural tasks when designing earthquake-resistant buildings is to insure that walls do not fall out.

Structural measures

When designing for earthquake-prone zones, it should be considered that the seismic forces acting on a building are proportional to its mass, and that deflection increases significantly with height. When designing two-storeyed buildings, therefore, it is advisable that the ground floor be built solid, while the upper floor is kept light, preferably with a flexible framed structure. Heavy roofs with slabs, slates and tiles should be avoided in principle.

Walls usually fall outwards because they lack a closed ring beam, sufficient bending and shear strength, and because door and window openings weaken the wall structure.

Under seismic influences, forces are concentrated into the corners of these openings, creating cracks. In order to reduce the danger of collapse, the following points should be kept in mind:

1. Houses should not be located on inclined sites (15.4).
2. The building's resonant frequency should not match the frequency of the earth movement during earthquakes. This means that heavy houses with solid construction should not rest on hard rock bases, but instead on

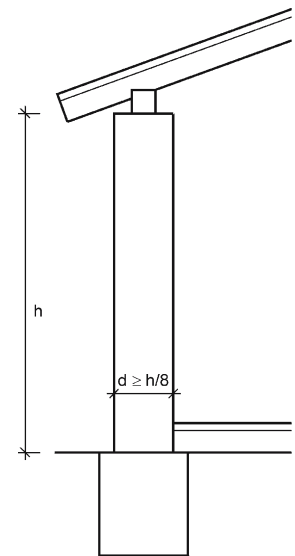

15.6

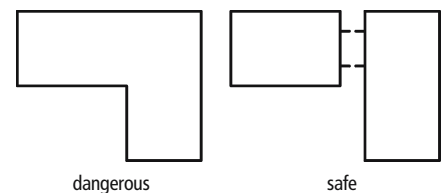
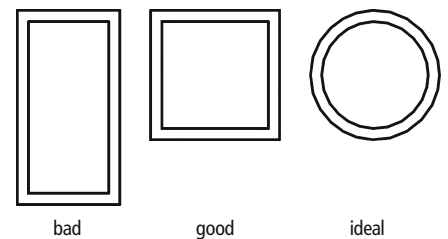

15.5

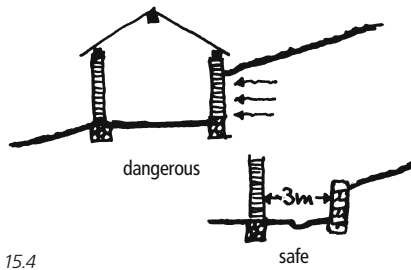

15.4



15.2 Wattle-and-daub house after heavy earthquake, Guatemala 1976

15.3 Earthquake-prone areas (Houben, Guillaud, 1984)

15.4 Location of houses on a slope

15.5 Ground plans

15.6 Wall proportion

15.7 Adobe walls, stabilised by buttresses

15.8 Stabilisation of walls

15.9 Destabilisation through horizontal impact of a vertical wall with a framed structure stabilised by tensile diagonals

sandy or silty soils. Light houses, however, perform better on hard rock than on soft soil.

3. The different parts of a house should not have foundations on different levels, nor have differing heights. If they do, then they should be structurally separated. Since sections of different heights display differing resonant frequencies, they should be allowed to oscillate independently.

4. Plans should be as compact as possible, and should be symmetrical. Circular plans give better rigidity than rectangular ones (see 15.5).

5. Foundations have to act like stiff ring anchors, and should therefore be reinforced.

6. Foundations, walls and roofs should be well fixed to each other, the joints being

able to withstand the shear forces produced.

7. Walls must be stable against bending and shear forces. Masonry work must have fully filled joints and strong mortar.

8. Load-bearing masonry walls should have minimum thicknesses of 30 cm; their heights should not exceed eight times their thicknesses (15.6).

9. Masonry walls should be stiffened with piers at a minimum every 4 m (with minimum sections of 30 x 30 cm), or with posts that are structurally fixed in the foundation (i.e. able to take movement) (15.7).

10. Wall corners, joints between walls and across walls, as well as door openings have to be stiffened by vertical posts of either timber or reinforced concrete, which are structurally fixed in the foundation, or by buttresses, so that horizontal forces do not open these elements (15.8, 15.22).

11. Walls have to be finished on top by a ring beam, which has to be adequately fixed to the walls.

12. Extra lintels above doors and windows should be avoided, and should be formed by ring beams (15.21).

13. Roofs should be as light as possible.

14. The horizontal thrusts of vaults and domes should be sufficiently contained by ring beams, buttresses or ties.

15. Openings destabilise walls and should be carefully proportioned (15.23).

There are two basic approaches to designing for earthquake resistance. The first and most commonly used method is to construct walls, roofs and their joints stiffly

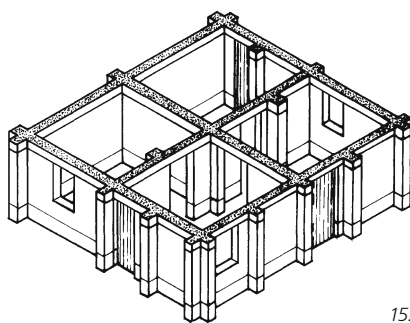

15.7

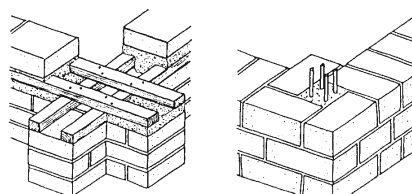
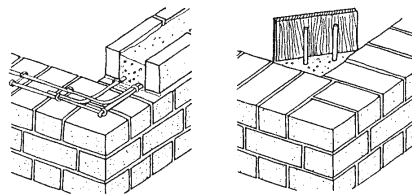
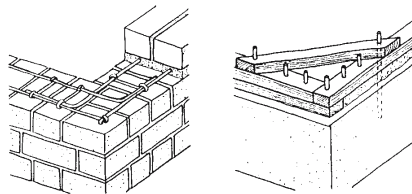

15.8

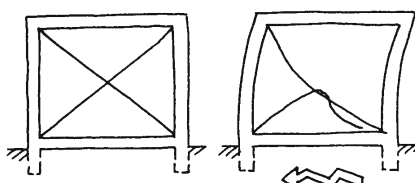

15.9

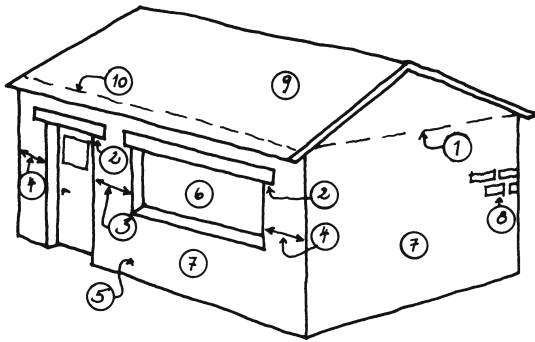

15.10

- 1 Ring beam is lacking.
- 2 Lintels do not reach deeply enough into masonry.
- 3 The distance between door and window is too small.
- 4 The distance between openings and wall corner is too small.
- 5 Plinth is lacking.
- 6 The window is too wide in proportion to its height.
- 7 The wall is too thin in relation to its height.
- 8 The quality of the mortar is too poor, the vertical joints are not totally filled, the horizontal joints are too thick (more than 15 mm).
- 9 The roof is too heavy.
- 10 The roof is not sufficiently fixed to the wall.

enough so that they cannot break or be deformed under seismic loads. The second approach is to endow the structure with sufficient ductility so that the kinetic energy of any seismic impact will be dissipated via deformation. This is the more intelligent solution, especially as it entails fewer structural problems and materials.

If, for example, a vertical wall with a framed structure stabilised by tensile diagonals is impacted horizontally from the right (as shown in 15.9), there will be a concentration of stress on both ends of the tie leading from lower left to upper right. Weakness, then, will occur first at these joints, possibly leading to wall failure. An elastically framed structure without diagonals, on the other hand – provided the corners are able to take some moment and that no structural element is overloaded – usually allows deformation to occur without leading to wall collapse. In the second case, obviously, the infill of the frame must also be somewhat flexible. Therefore, walls built with the wattle-and-daub technique in which a flexible network of horizontal and vertical components is plastered with loam, for example, are less prone to damage than masonry walls. Illustration 15.1 shows a house in Guatemala that was struck by a heavy earthquake and was flexible enough to withstand the stress. There are three different general principles for designing earthquake-resistant structures:

1. Walls and roof are well interconnected and rigid enough that no deformation occurs during earthquakes.

2. Walls are flexible (ductile) enough so that the kinetic energy of the earthquake is absorbed by deformation. In this case it is necessary to install a ring beam strong enough to take bending forces; the joints between wall and ring beam, and ring beam and roof must be strong enough.

3. The walls are designed as mentioned under 2, but the roof is fixed to columns that are separated from the wall, so that both structural systems can move independently, since they have different frequencies during an earthquake.

Three research projects undertaken by the Building Research Laboratory, University of Kassel, Germany, analysing earthquake damage to single-story rural houses in Guatemala, Argentina and Chile, concluded that the same errors in structural design consistently led to collapse. The ten principal mistakes are listed in 15.10.

At the BRL, a simple test was developed within the context of a doctoral thesis to show the influence of wall shape on resistance to seismic shocks. A weight of 40 kg at the end of a 5.5-m-long pendulum was allowed to fall against a model (15.16). The rammed earth house with a square plan showed the first large cracks after the second stroke (15.11). After three strokes, one section of the wall separated (15.12), and after four strokes the house collapsed (15.13). The rammed earth house with circular plan, however, displayed initial cracks only after three strokes (15.14), and one small section of the wall separated only after six strokes (15.15) (Yazdani, 1985).



15.11



15.12



15.13



15.14



15.15

15.10 Typical design mistakes which might lead to a collapse of the house

15.11 to 15.15 Earthquake tests with models of square and circular shape (Minke, 2002)



15.16 Simple test to study the influence of wall shape on resistance to seismic shocks (BRL)
 15.17 Elements with correct corner details
 15.18 Corner solution
 15.19 Recommended proportions

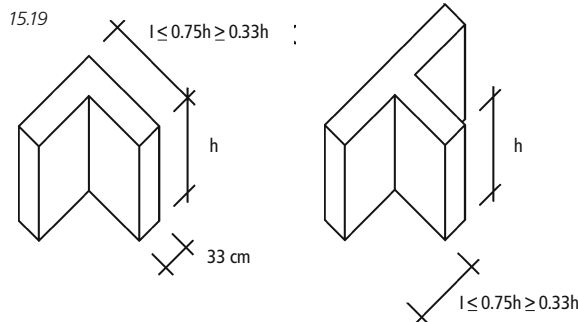

A simple solution for stabilising rammed earth walls of lesser thicknesses is to use L, T, U, X, Y or Z shaped elements (15.17). Due to their angles, they have better stability against lateral forces. If a wall is 30 cm thick, the free ends of the elements should not be longer than $\frac{3}{4}$ and no shorter than $\frac{1}{3}$ of their heights (see 15.19). This minimal length is necessary to transfer loads diagonally to the plinth or foundation. If the free ends are longer than $\frac{3}{4}$ of their heights, they should be stabilised by another angle. If the angle is well fixed on the bottom to the plinth and on the top to a ring beam, it should be larger or higher. Nevertheless, height should not exceed the width by eight times (see 15.6).

The forces perpendicular to the wall are transferred into the angle parallel to the direction of force. This means that it is transferred, instead of creating a concentration of stress at the inner corner of the angle. It is advisable, therefore, to enlarge the section at this corner, as shown in 15.17 and 15.18.

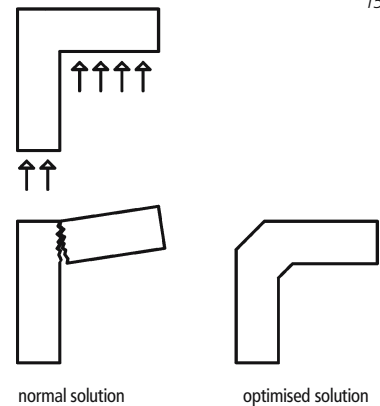
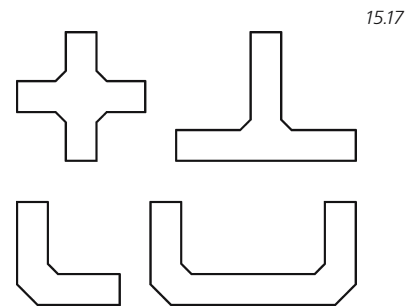

Openings for doors and windows

Wall apertures will destabilise a wall system. During earthquakes, diagonal cracks often occur, starting at the window edges (15.20). In order to achieve a good bond, lintels must penetrate at least 40 cm into the wall (15.21). In this case, however, the area above the lintel may be weak and may come off during an earthquake, so the best solution is to use the lintel as a ring beam on which the roof structure rests. It is also recommended that the section below the window be built as a light, flexible structure, for instance from wooden panels or wattle and daub. The following rules have to be taken into account (15.23 and 15.24).

- a) The width of a window should not be more than 1.2 m and not more than $\frac{1}{3}$ of the length of the wall.
- b) The length of walls between openings must be at least $\frac{1}{3}$ of their height and not less than 1 m.
- c) Doors must open outward. Opposite the entrance door should be a large window or another door, which acts emergency exit (15.24).

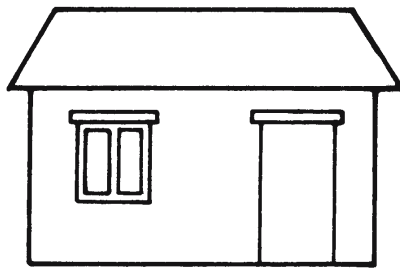

dangerous

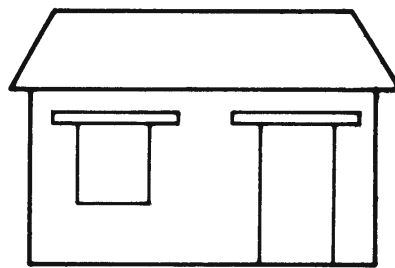

acceptable

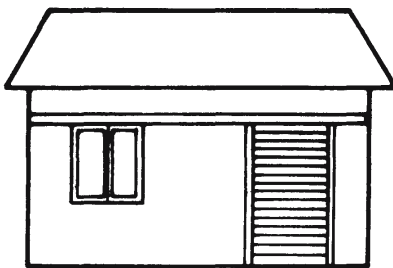

better

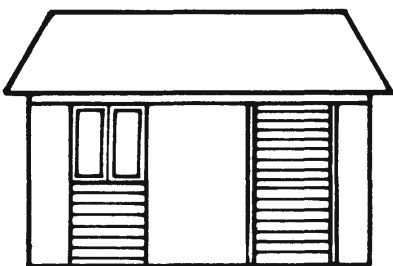

best

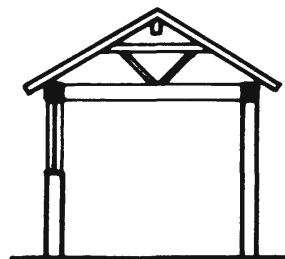

15.21

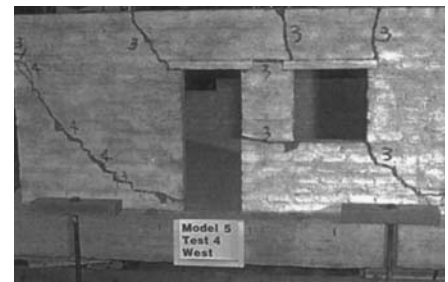

Model 5
Test 4
West

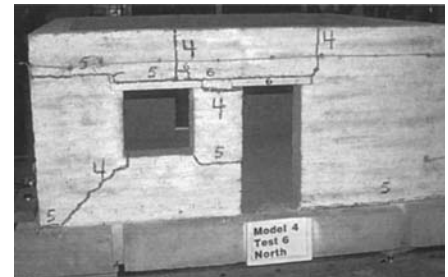

Model 4
Test 6
North

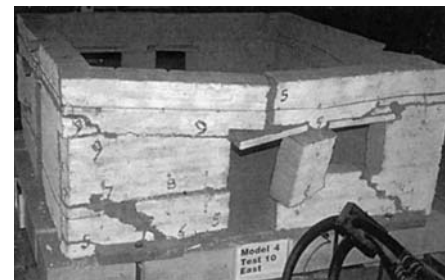

Model 3
Test 10
East

15.20

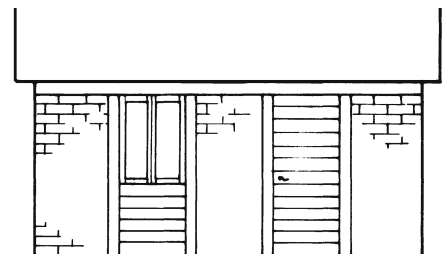

15.22

15.20 Typical failures caused by seismic movements (Tolles et al., 2000)

15.21 Types of lintels

15.22 Stabilised openings

15.23 Recommendable dimensions of openings

15.24 Recommendable positions of openings

15.25 to 15.26 Earthquake-resistant low-cost housing prototype with bamboo-reinforced rammed earth walls, Guatemala 1978

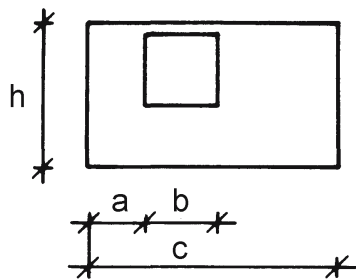

$$a \geq h/3 \geq 100\text{cm}$$

$$b \leq c/3 \leq 120\text{cm}$$

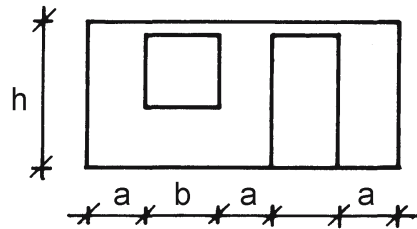

$$a \geq h/3 \geq 100\text{cm}$$

$$b \leq h/2 \leq 120\text{cm}$$

15.23



15.25

Bamboo-reinforced rammed earth walls

A bamboo-reinforced panelled rammed earth wall technique was developed in 1978 as part of a research project by the BRL, and successfully implemented jointly with the Francisco Marroquín University (UFM) and the Centre for Appropriate Technology (CEMAT), both in Guatemala (15.25 to 15.29).

In this project, 80-cm-wide and one-storey-high bamboo-reinforced rammed earth elements were constructed using a T-shaped metal formwork 80 cm wide, 40 cm high

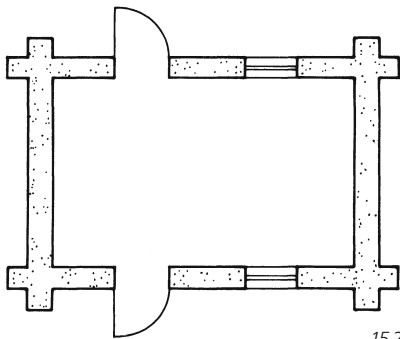

15.24

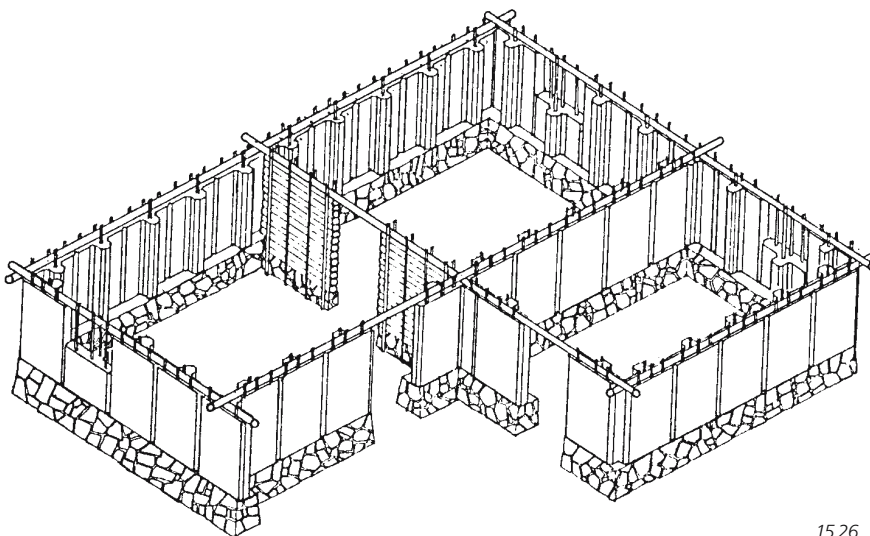

15.26

and 14 to 30 cm thick (15.28). The stability of the wall was provided by four built-in bamboo rods 2 to 3 cm thick and the T-shaped section of the wall element. These elements were fixed at the bottom to a bamboo ring anchor that was embedded in the stone masonry plinth, and attached at the top to a rectangular bamboo ring anchor.

Due to the rib that was integrated into the wall element, this element has about four times stronger resistance against horizontal forces than a 14 cm wall alone would have had.

After drying, a 2 cm vertical gap appears between these elements. This is then packed with loam. This joint acts as a pre-designed failure joint, allowing an independent movement of each element during the earthquake.

This means that these joints can open and the whole structure can deform (dissipating seismic kinetic energy) without the wall unit breaking or falling. The posts on which the roof rests are located 50 cm away from the walls (15.27) on the inside, so that the roof structure is independent of the wall system. The rammed earth surface was not plastered, but only smoothed by a trowel and then painted with a mixture made of one bag of hydraulic lime, 2 kg common salt,

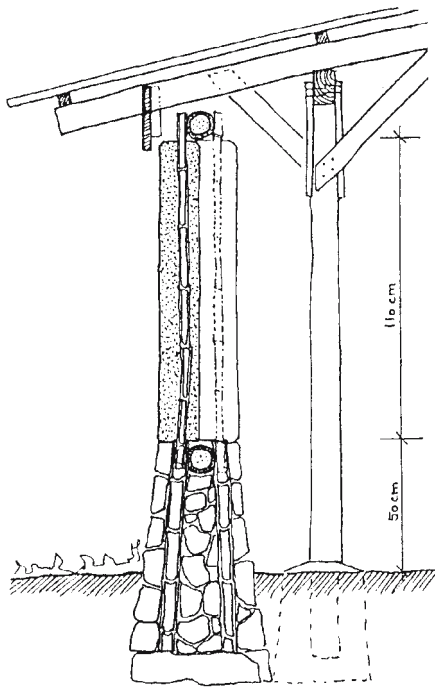

15.27



15.28

15.27 to 15.29 Earthquake-resistant low-cost housing prototype with bamboo-reinforced rammed earth walls, Guatemala 1978
 15.30 to 15.32 Earthquake-resistant prototype building, Alhué, Chile, 2001

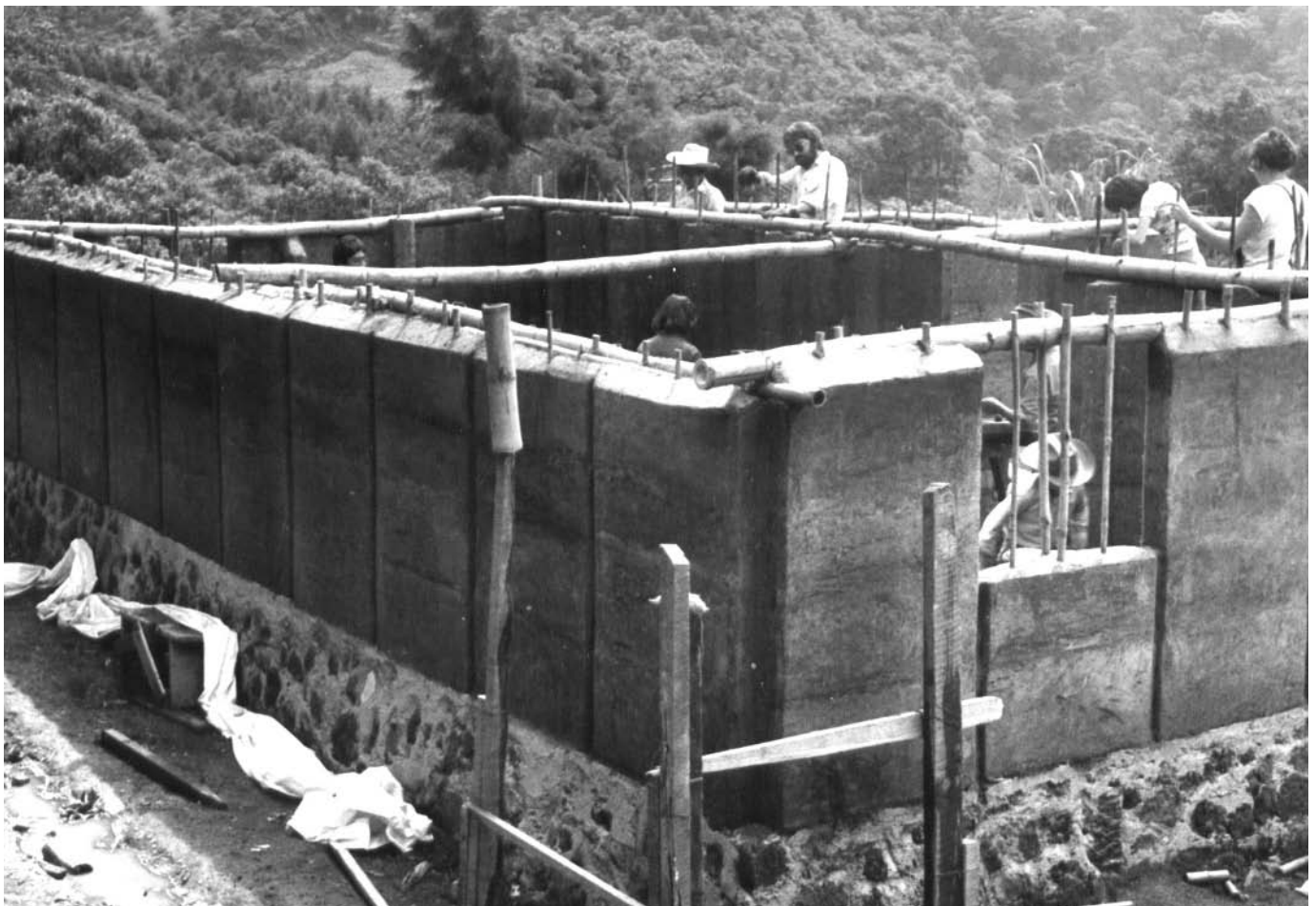

15.29

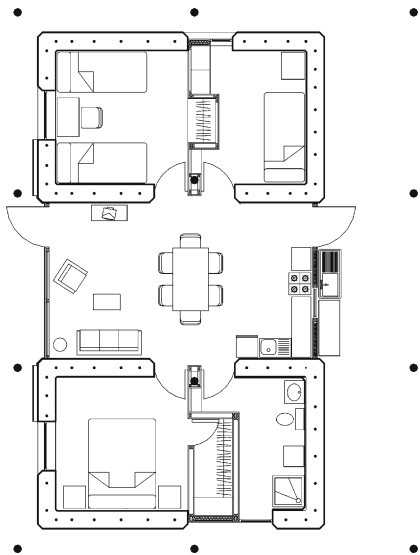

15.31



15.30

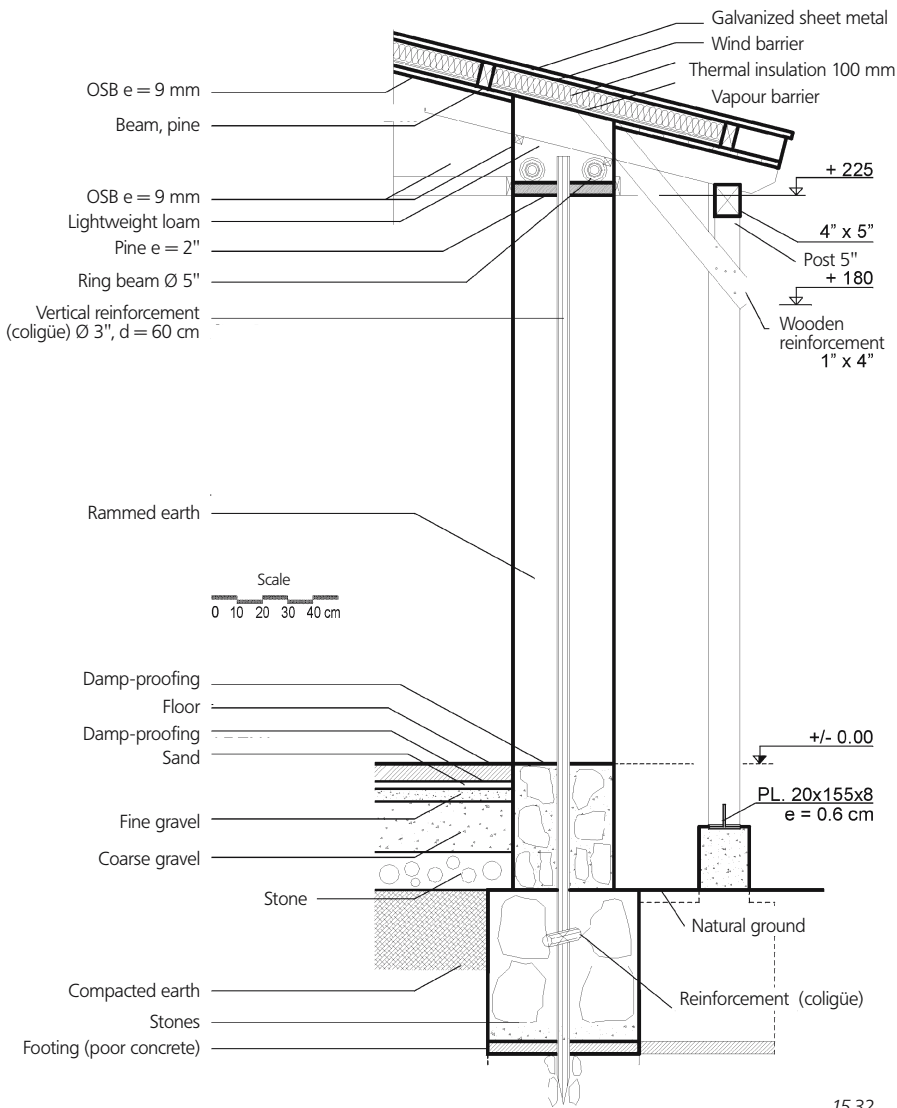

15.32

1 kg alum, 1 kg clayey soil and about 40 litres of water.

In 1998 the BRL developed another reinforced rammed earth wall system that was utilised for a low-cost housing project built in cooperation with the University of Santiago de Chile in Alhué, Chile, in 2001 (see 15.30 and 15.31). Here too, the idea was to separate the roof from the wall system and to use U-shape and L-shape elements, which stabilise themselves by their shape. To obtain additional stability, they were reinforced by vertical rods of coligüe (similar to bamboo), 3 to 5 cm in diameter. Wall elements were also always separated by light, flexible elements, or by doors and windows. The lower parts of the windows and the parts above the doors were not built with solid elements, but of light timber. The gables were built in lightweight straw-loam stabilised by wooden elements, similar to the wattle-and-daub system.

Domes

In order to construct a structurally optimised dome without formwork, the BRL developed a rotational guide that is fixed to a vertical mast. An angle is fixed at the end of the rotating arm, against which the mason lays the adobe or soil block, allowing block to be positioned with precision. Illustrations 15.33 to 15.36 show the application of this construction technique for an earthquake-resistant dome with an 8.8 m free span that is 5.5 m in height, built in La Paz, Bolivia, in 2000. The dome is stabilised by two reinforced concrete ring beams, one at the bottom of the dome, another at the top of the foundation. In order to provide good sound distribution within the dome, the adobes

were made by hand in a special mould with rounded edges. The acoustic behaviour of the dome was further refined by deepening the vertical joints in order to achieve some sound absorption and by a slight cantilevering position, which prevents the sound from being focused towards the centre of the dome.



15.34



15.33

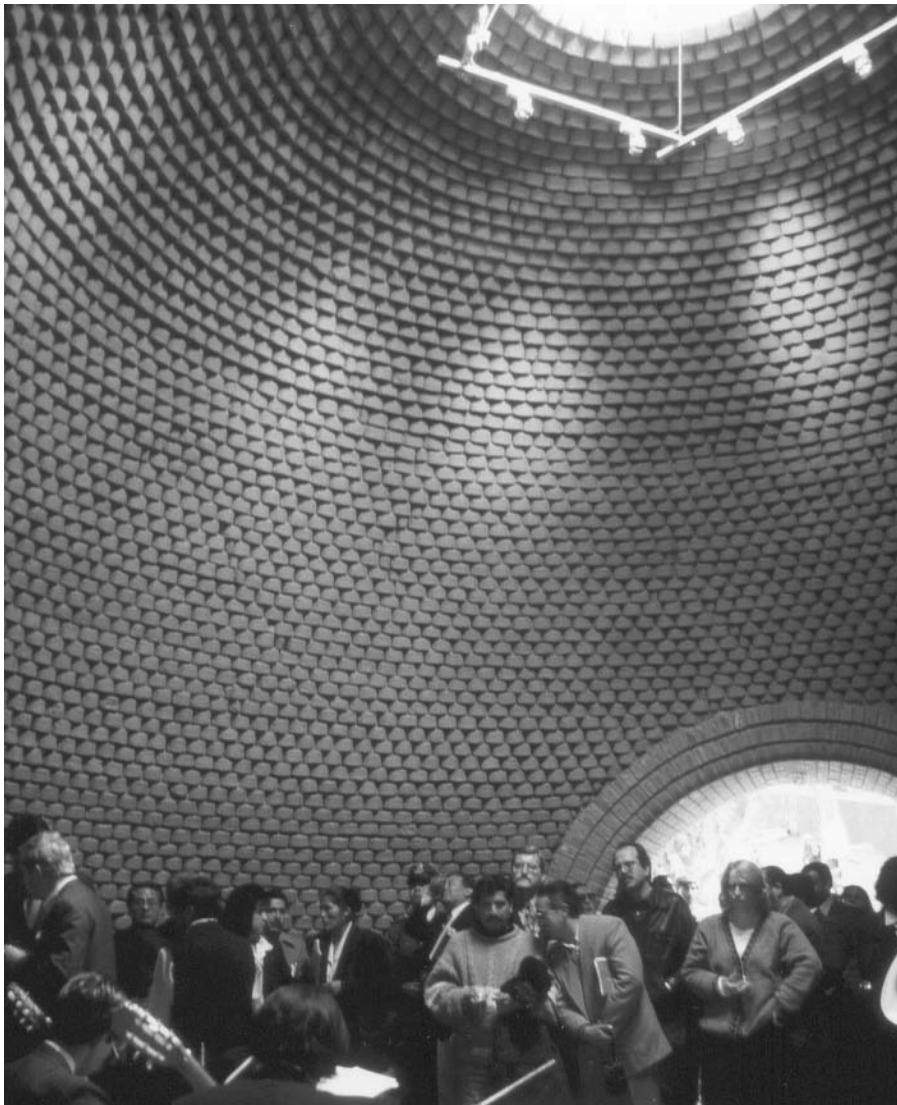

15.36

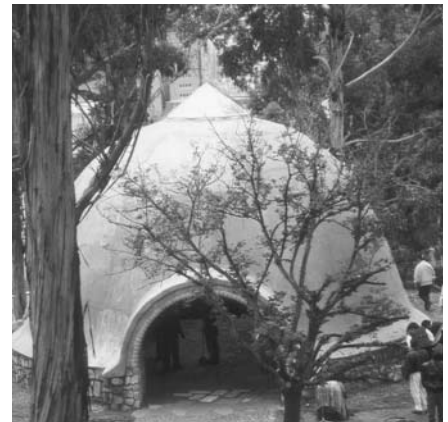

15.35

15.33 to 15.34 Rotational guide

15.35 to 15.36 Finished dome

15.37 Wrongly designed plinth with eccentric thrust line, which collapses easily when hit by seismic shocks

15.38 Earthquake-resistant design for a low-cost housing project in Gujarat, India

15.39 to 15.40 Dangerous shapes of vaults, Bam, Iran

15.41 Vault which withstood earthquake at Bam, Iran, Dec. 2003

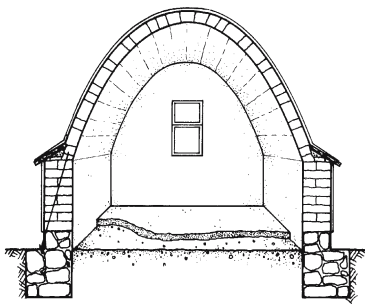

15.37

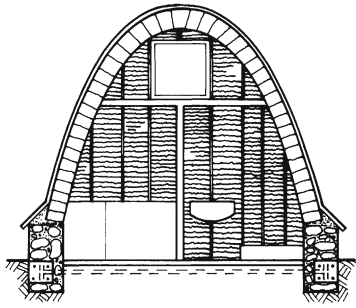

15.38



15.39

Vaults

An important rule for the design of plinth and foundation is that the resulting force at the bottom of the vault must pass through the inner third of the surface of the foundation. This means that eccentricity should be less than $\frac{1}{6}$. The foundation must have a reinforced concrete or steel beam, which can also withstand the additional horizontal forces created by an earthquake.

Illustration 15.37 shows a section of a building which was built in an earthquake-prone area in Bolivia. Its plinth has structurally dangerous proportions, as the resultant force from the vault creates a bending moment in the plinth and does not stay within the inner third of the wall, as necessary. This structure will readily collapse when hit by an earthquake.

The cross-section of a vault is very important for stability. For vaults that carry only their own dead loads, an inverted catenary is the optimal section, as no bending moments will occur within the vault. Pointed vaults, as shown in 15.39, or "flat" vaults as shown in 15.40, typical for Iranian architecture, collapse very easily when hit by seismic shocks, whereas the vault in 15.41 withstood the heavy earthquake in Bam, Iran, in December 2003. Only the front part fell off.

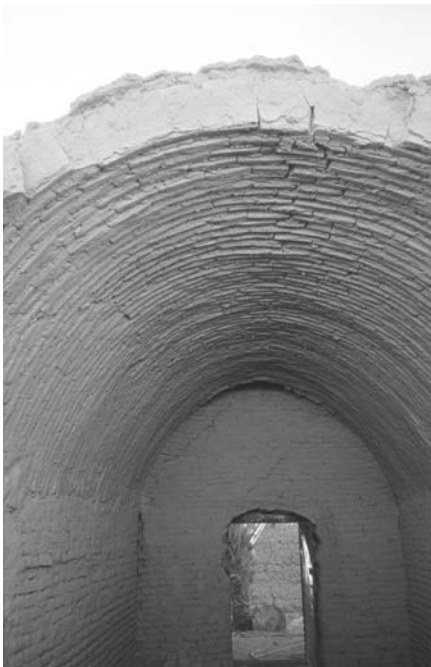

15.41



15.40

The best solution for the facades of vaults is to build them to be light and flexible, either of mats covered with earth plaster, or of timber planks.

Illustration 15.38 shows a design by the author for an earthquake-resistant low-cost housing project in the region of Gujarat, India.

In 2001, a proposal by the author for stabilising adobe vaults with bamboo arches, which guarantee a certain degree of ductility, was realised in a test structure built in 2001 at the University of Kassel, Germany (15.42 to 15.45). It was built using special U-shaped adobes that rest on an arch, itself built of three layers of split bamboo. The bamboo sections were soaked in water for three days in order to render them flexible. Then they were bent over sticks, which were pushed into the ground along a catenary curve (15.43). To maintain the shape of the arch, the three bamboo sections were



15.44



15.45

wrapped together with galvanised steel wire at 50 cm intervals. The arch was vertically positioned and fixed to steel bars that stick out of the plinth. This connection must be capable of absorbing tensile forces during an earthquake. Above the adobe vault, a membrane of PVC-coated polyester fabric was fixed and tightened to the plinth. This has two functions: first, it provides shelter against rain and wind; second, it pre-tensions the arch, thereby increasing its stability against tremors during earthquakes. Such tremors may deform the vault to a certain extent, causing adobe joints to open, but the vault will not collapse, since it is held up by the tensile pre-stressed membrane at the top and the compressive pre-stressed bamboo arch underneath. The stability of this structure, then, depends mainly on its ductility. However, it must be

taken into account that if the pre-tension of the membrane is high, the optimal section of the vault is more like an ellipse and not a reversed catenary. For earthquake regions in Argentina and Iran, the author developed a similar pre-tensioned system for mud brick vaults. Illustration 15.46 shows a design for an orphanage building in Bam, Iran, where vaults are constructed with thicknesses of 25 cm. They are pre-tensioned by steel strips, which are tightened to the reinforced concrete ring beam at the bottom of the vault. Equal pre-tension forces in all parts are ensured by using a calibrated torque wrench. The optimal section of the vault is derived by a computer programme. It guarantees that the resultant forces from the dead load of the structure and the pre-tension forces run along the middle of the vault cross-section.



15.42

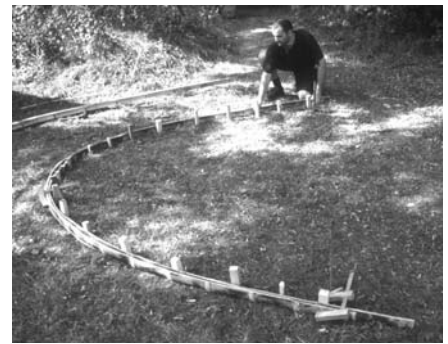

15.43

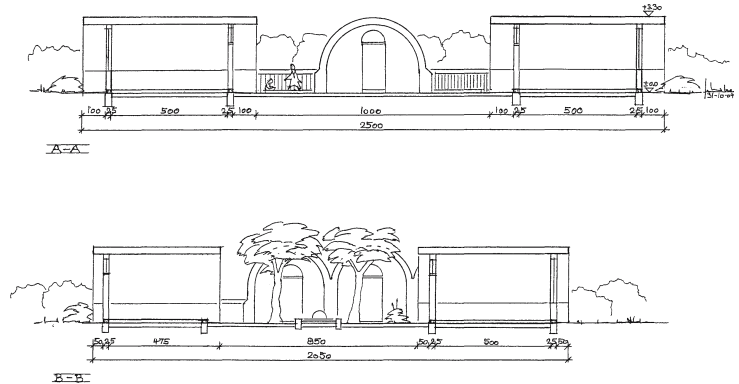
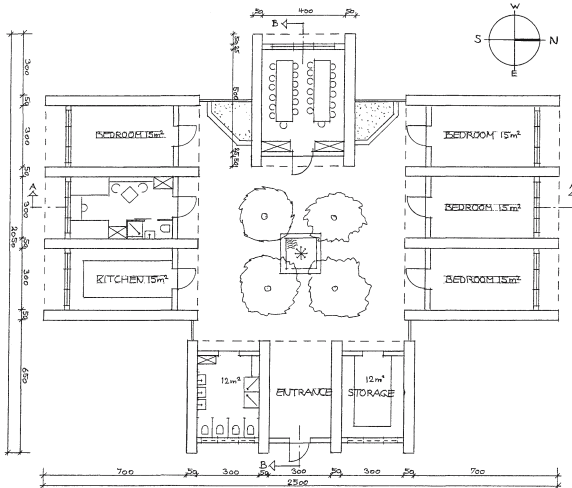

15.46

- 15.42 Manufacturing custom-tailored adobes
- 15.43 Preparing bamboo arches
- 15.44 Test vault
- 15.45 Vault with post-tensioned membrane cover
- 15.46 Design for an orphanage in Bam, Iran
- 15.47 Dome, Kassel, Germany, 1997
- 15.48 to 15.49 Prefabricated wall elements
- 15.50 Prototype building, Kassel, Germany, 1978



15.47



15.48



15.49

Textile walls with loam infill

A BRL research project begun in 1977 examined various approaches to forming walls using textile components filled with clayey soil, pumice or sand.

Illustration 15.47 shows the dome structure built in 1977, from earth-filled polyester hoses.

Two newly developed systems were tested in a prototypical low-cost house intended for earthquake-prone areas in developing countries. The first, illustrated in 15.50, consisted of walls formed by two layers of jute fabric. Thin wooden posts are hammered into the ground, and the fabric fixed to these from the inside. The space between is filled with soil.

The research also showed that wall elements of this type without infill can be prefabricated to lengths of up to 10 m and then folded and rolled up into small bundles (see 15.48 and 15.49).

The second system consists of hoses of jute fabric filled with pumice or sandy soil (15.51). The fabric is covered with several



15.50



15.51

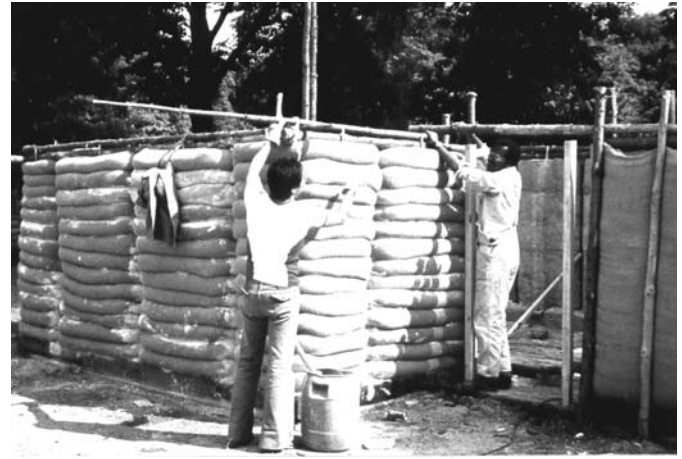

15.52



15.53



15.54

layers of lime paint (15.52) in order to prevent rotting of the material and to stabilise the surface and make it waterproof. As part of a cooperative research project of the BRL with UFM and CEMAT from Guatemala in 1978, a 55 m² low-cost prototype house was erected in Guatemala using earth-filled hoses for the walls. This technique, developed during experiments with the earth-filled hose technique described earlier, and adapted to local conditions in Guatemala (15.53 to 15.55), shows very good earthquake resistance due to its ductility. Here, the hoses, measuring 10 cm in diameter, were made from cotton fabric, and were filled with volcanic soil containing mainly pumice. They were dipped into lime milk (in order to prevent rotting of the fabric), and then stacked between twin vertical posts erected at distances of 2.25 m. Additional stability was provided by bamboo rods fixed vertically at a spacing of 45 cm within each panel. After the walls were stacked, they were finished with two layers

of lime paint. The roof structure rests on independent posts located 50 cm away from the walls on the inside. The material costs of this structure were only about one half the cost of a comparable house made of cement concrete blocks. Walls built of fabric hoses filled with mineral lightweight loam are described in chapter 10, p. 90 and chapter 14, p. 133.

15.51 to 15.52 Prototype building, Kassel, Germany
15.53 to 15.55 Low-cost housing prototype, Guatemala, 1978



15.55

II Built examples

As shown by the examples in this chapter, modern houses whose principal building material is loam need have no particular or characteristic type of outward appearance. They can be traditional or modern, simple or sophisticated, humble or exclusive. In cold climates, the loam as a building material is normally not visible from the outside, since it is covered by the necessary additional thermal insulation and weather protection materials. Interiors, however, can display a variety of earth building techniques and their manifold applications. In this chapter, various buildings of this kind are documented, together with examples from warmer climatic zones where less thermal insulation is needed; these examples, hence, also display earthen exterior surfaces.



Two semi-detached houses, Kassel, Germany

These two houses are characterised by their green facades and roofs, which merge with the landscape, and by their ecologically appropriate concept. The notable feature of the layout is that the rooms are disposed around a central multi-purpose hall with a gallery above, thereby avoiding corridors and integrating a winter garden. All interior walls display timber frame and exposed loam surfaces. The timber roofs show special domical designs made from timber logs. Shelves and even the sink in the bathroom were built from unbaked loam (see chapter 14).

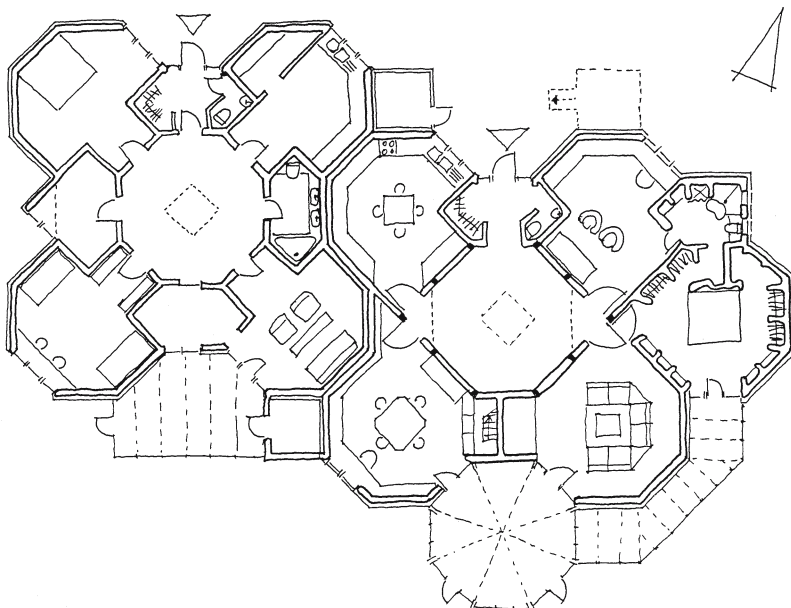

Architect: Gernot Minke, Kassel, Germany

Completion: 1985

Area: 160 m² + 120 m²

Foundation: Plain concrete strip foundation

Flooring: 27 cm coarse gravel; covered with thermal insulation and timber plank floor or 14-cm-thick lightweight mineral loam with sisal floor matting and, in wet rooms, cork tiles

External walls: Green bricks, extruded loam all with additional thermal insulation, air cavity and untreated wooden larch boards

Internal walls: Timber frame with infill of extruded loam elements

Roof: Timber structure; 12 cm thermal insulation; 2-mm-thick hot-air welded PVC-coated polyester fabric; 15 cm of earth mixed with expanded clay; living wild grasses





Interior views of two semi-detached houses, Kassel, Germany

■ Residence cum office, Kassel, Germany

A combined residence/office building was built in 1992 within a residential suburb of Kassel, Germany, that built according to ecological standards. All main rooms as well as a bathroom and the winter garden are covered with earthen domes. The entrance is covered by three jack vaults built of green bricks, as explained in chapter 14. The central lobby is covered by a dome with a clear span of 5.2 m and a clear height of 4.6 m, which is provided with a skylight consisting of a double-layered acrylic glass dome. Leading off from this lobby are four additional domed rooms. Each room has the same span, with a clear height of 4 m, and each is provided with a central skylight and one window at normal height. The construction of these five domes was carried out using the rotational guide described in chapter 14. Though the central dome springs from a height of 1.75 m, and the domes of the four other rooms at heights of 0.75 m, no ring beam is necessary, the structure being designed so that all resultant forces fall within the middle third of the foundations. The domes in the bathroom and winter garden are formed over an irregular hexagon, and were built using a technique derived from the Afghan dome technique (see chapter 14) using arches inclined at angles of 40-60° from the horizontal.

The eye-shaped opening remaining once the two sets of arches reach the point at which they converge is covered by changing the pattern of arches by 90°. All domes are covered with an additional layer of 20 cm rock wool for thermal insulation and sealed with a 2-mm-thick, hot-air welded reinforced plastic membrane, which is waterproof and 'root-proof'. This is covered with 15 cm of earth, which acts as substrate for the frost-resistant and drought-resistant wild grasses.

The single-storeyed house has a floor area of 216 m², including the winter garden. Walls, shelves and sanitary objects are cov-

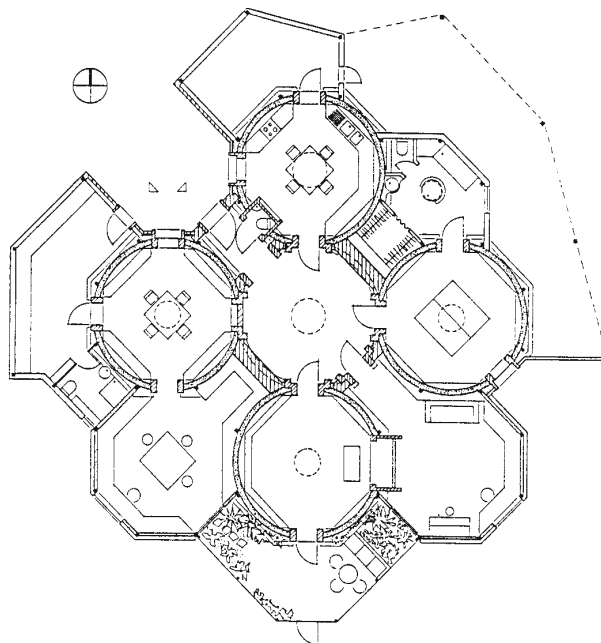
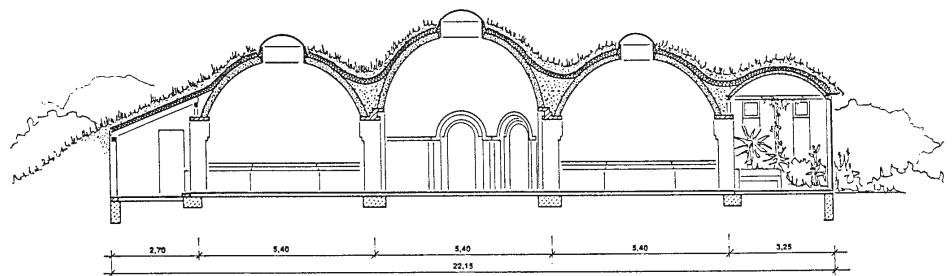



ered by earth-filled hoses and even the bathroom sink is made from unbaked loam (see pages 132 and 133)

Architect: Gernot Minke, Kassel, Germany

Completion: 1993

Area: 155 m² (home) + 61 m² (office)



Residence cum office,
Kassel, Germany





■ Farmhouse, Wazirpur, India

The single-storeyed house, with a floor area (including veranda) of 206 m², is mostly set into the earth berms towards the north of the lake. The south side is exposed to the winter sun and is shaded against the summer sun by overhangs and louvers. The rooms are arranged around a central patio containing a small pool with plants. This enables cross ventilation for all rooms and cooling by evaporation. The plan was generated by a pattern of octagons and squares. The structural frame consists of load-bearing stone columns which support beams and stone slabs to form slightly domical enclosures over all rooms. A light coloured stone roof above this structure creates an air cavity and thus reflects solar radiation and provides shade to the thin roof below. The infill walls are built with adobes (handmade mud bricks). Wherever the berms cover the external face, an air cavity is formed by an inclined stone slab resting against the wall. All external surfaces of the building have either air cavities or summer shading by overhangs and louvers. The stone louvers of all windows are designed to take over the function of the usual steel security grill, and at the same time provide sun shading as well as the reflection of daylight into the rooms. Additional cooling in the summer months is provided to all rooms by an earth tunnel system. The distance from the 2 kW fan to the building is about 60 m. The section consists of two masonry ducts at average depths of 3 m below surface. The maximum air velocity is kept to 6 m/sec. The elements of passive climatisation are shown in the drawing below.



Architects: Gernot Minke, Kassel, Germany, and DAAT, New Delhi, India
 Completion: 1993
 Area: 206 m²
 Walls: Stone columns with adobe infill
 Roof: Double layer of sand stone slabs with air cavity

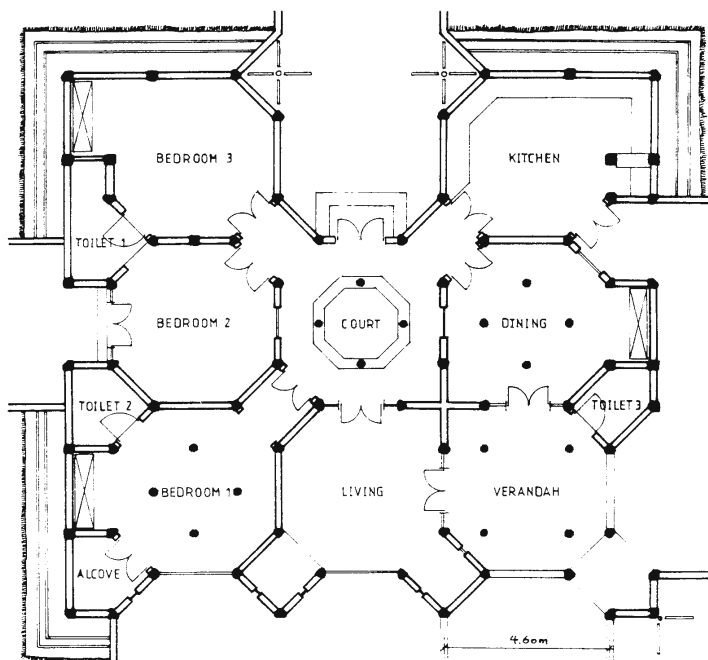

PLAN

■ Honey House at Moab, Utah, USA

This country house was built from earth-filled rammed tubes or sacks. The thickness of the walls is 50 cm, and the diameter of the interior space is 3 m. Forty tons of earth were used in all.

The exterior surfaces are covered with straw-loam plastering, and the edges of the openings and the pedestal with loam plastering. Inner surfaces were plastered with loam.

Design and construction: Kaki Hunter, Donald Kiffmeyer, Moab, UT, USA

Completion: 1998

Area: 11 m²

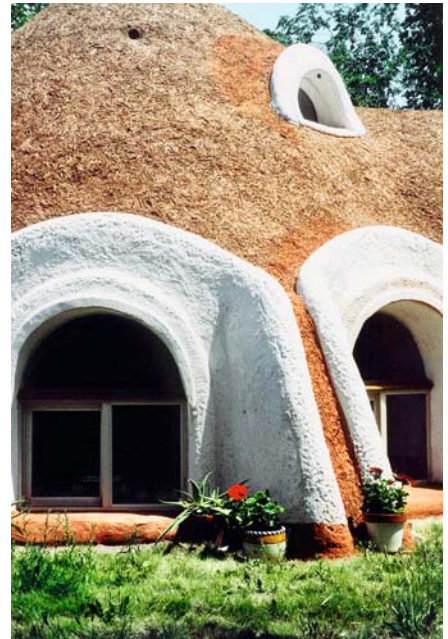

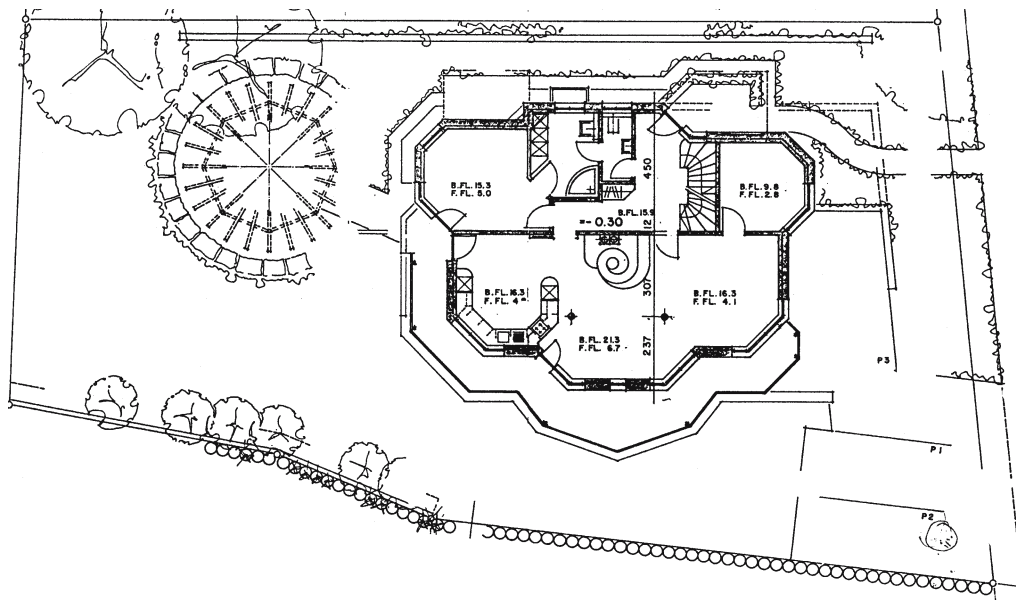

■ Three-family house, Stein on the Rhine, Switzerland

The building is a three-storeyed post-and-beam structure that is planked with diagonal buttressing sheathing. The outer walls bear an exterior lime plastering on lightweight wood wool construction slabs, behind which lies a 12-cm-thick cellulose insulation. The insides of the exterior walls consist of 20-cm-thick rammed lightweight woodchip shaving loam coated with loam plastering. The weather-exposed gable is provided with rear-ventilated larch wood sheathing. The inner walls are filled in with adobes. The brick roof and the balcony project outward so that the southern rooms are shadowed in summer, yet admit sunlight in wintertime.



Design: Michael Nothelfer, Überlingen, Germany

Completion: 1997

Area: Basement level: 82 m²

Ground floor: 118 m²

Attic storey: 108 m²



Residence, La Paz, Bolivia

The residence is situated at the edge of Bolivia's capital at a height of 3700 m above sea level. It is built of handmade adobes and consists of three crossing vaults. The vaults have thicknesses of 30 cm and give a positive time lag for sun radiation. This means that solar radiation enters the rooms in the evening and at night when outdoor temperatures are low. The vaults are plastered with an earth plaster, which is covered by an elastic acrylic paint to provide shelter against rain.

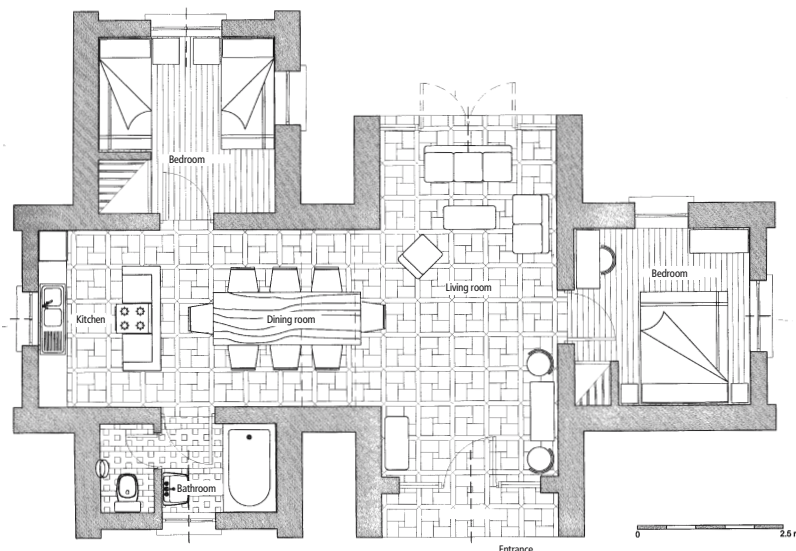

Architect: Raul Sandoval, La Paz, Bolivia

Completion: 1999

Area: 84 m²

Residence, Turku, Finland

The partly two-storey-high building stands at the border of the city and accommodates a family of five. The structural system of the walls is provided by a timber skeleton. The exterior walls are formed by 40-cm-thick prefabricated cubes composed of a mixture of clayey soil and straw. Their specific weight is 450 kg/m³. These blocks are covered either by timber planks or lime plaster. The U-value of the walls is 0.28 W/m²K.

Architect: Teuvo Ranki, Turku, Finland

Completion: 1999

Area: 127 m²

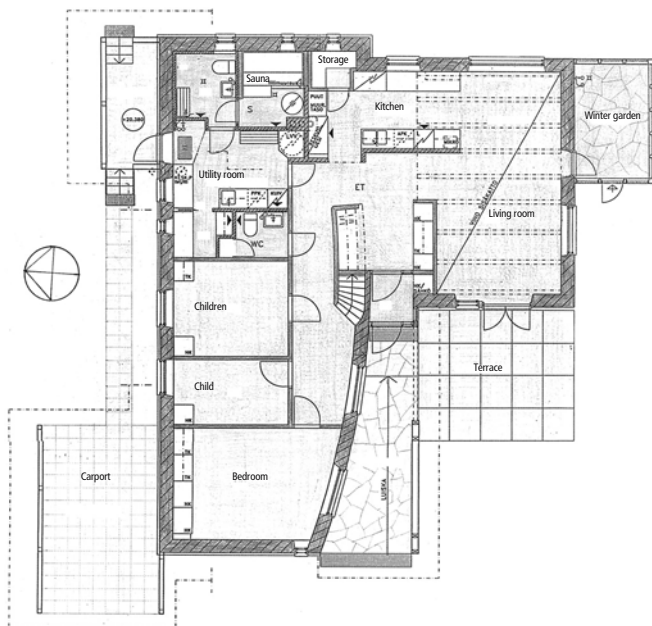



Residence and studio at Gallina Canyon, New Mexico, USA

The two-storey residence, built of sun-dried, unstabilised and locally made adobes, provides spectacular views from its terraces and roof top of the Gallina Canyon in the Sangre De Cristo Mountains, north of Taos, New Mexico. It displays several features of environment-conscious design, such as passive solar heating through a combination of direct solar gain with a thermal chimney, which distributes warm air to the cooler rooms on the north side of the house. Electricity is backed up by a photovoltaic system, and water from the roofs is harvested for gardening purposes. Interior surfaces



show on-site mud plaster finishes, flagstone floors and recycled oak beams.

Architect: ONE EARTH DESIGN, Joaquin Karcher, Taos, NM, USA

Builder: Aqua Fria Construction, Ed Baca, Taos, NM, USA

Completion: 2001

Area: 390 m²





■ **Residence at Des Montes,
near Taos, New Mexico, USA**

This sumptuous residence is located near Taos, New Mexico, a town and area that has a long tradition in adobe constructions. The house provides two bedrooms, a circular living room with a guest sleeping loft above and an open kitchen/dining area. The roof terrace above offers breathtaking views of the surrounding mountains. The house has two porches, one of them opening towards a walled garden with a water fountain. All walls are built of handmade adobes and are mud plastered; sometimes

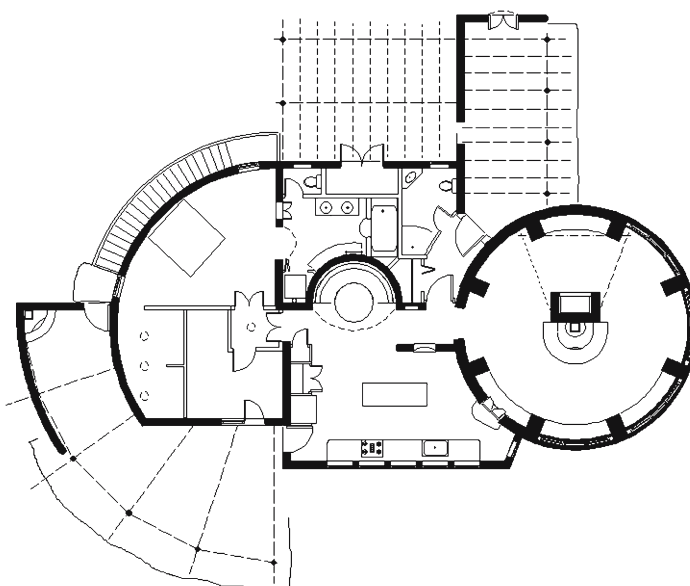
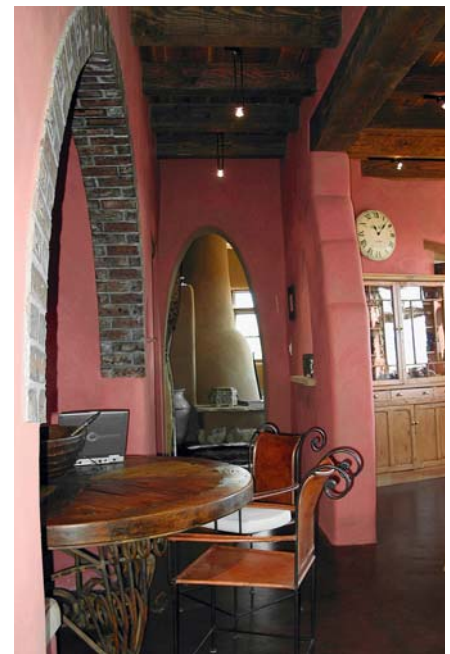

natural pigments were added. Only natural and non-toxic finishes have been used. Other green features include a passive solar design concept, a solar hot water system and a stained concrete floor with radiant heat, locally harvested lumber and a roof water harvesting system which irrigates the gardens.

Architect: ONE EARTH DESIGN, Joaquin Karcher, Taos, NM, USA

Builder: John Havener, Cadillac Builders, Taos, NM, USA

Completion: 2004

Area: 204 m²





**Casita Nuaanarpoq at Taos,
New Mexico, USA**

The rooms are grouped around a central staircase whose dark red coloration is highly visible from outside. The house is autonomous in energy terms, with photovoltaic cells supplying the required electricity. The passive harvesting of solar energy by the glass front, as well as the massive loam storage wall within and the highly effective thermal insulation provided by the outer walls, formed of balls of hay, result in adequate climate control for this house, set in a desert climate with extreme temperature differences.

Architects: Edge Architects; Ken Anderson,
Pamela Freund, Taos, NM, USA

Completion: 2004

Floor area: 140 m²

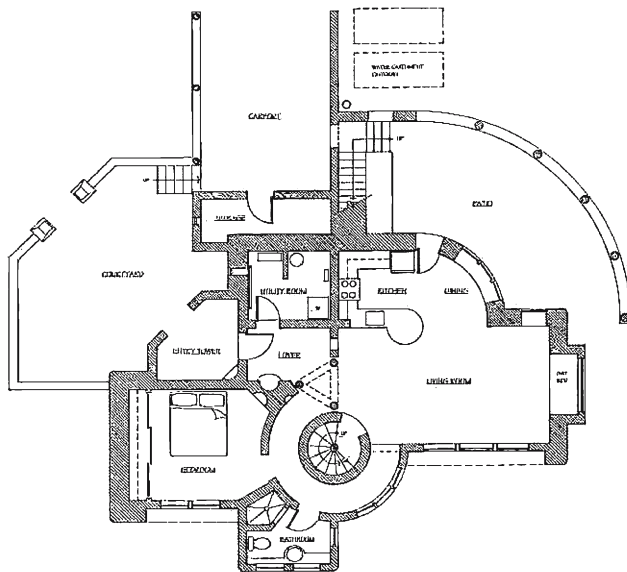

FIRST FLOOR PLAN

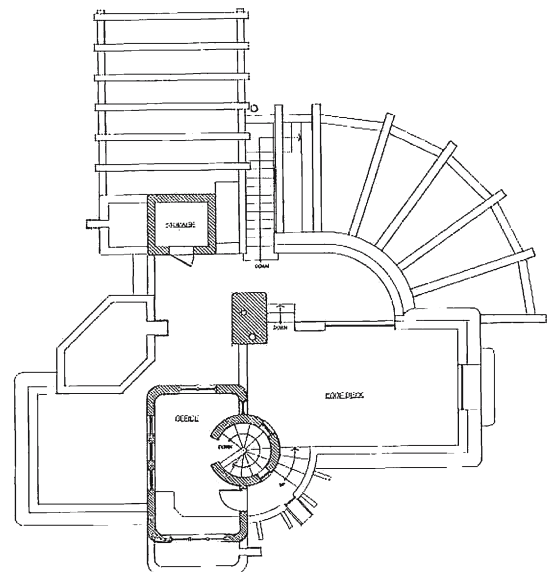

SECOND FLOOR PLAN



■ **Residence and office at Bowen Mountain, New South Wales, Australia**

The solar chimney exhausts warm air via a funnel effect. In winter, a wood stove provides additional heating as needed. The lower storey has a 3000 mm load-bearing wall of handmade adobes. The top storey has a post-and-beam timber structure with adobe infill of 250 mm externally and 200 mm respectively 120 mm internally. Walls are plastered on both sides with mud plaster. The exterior plaster is stabilised with cowdung. Large louvered glass openings allow views to the bush landscape and provide solar heat gain. A wood stove gives additional heat in winter.

Architects and builders: Ray & Lynne Trappel,
Bowen Mountain, Australia
Completion: 2004
Area: 230 m² (residence) + 80 m² (office)





■ Vineyard Residence at Mornington Peninsula, Victoria, Australia

The predominant elements of this residence, which is situated in a large vineyard, are the rammed earth walls. The living area extends out to the north veranda, the kitchen to an informal terrace area. The study opens up to the garden.

The principal bedroom, with its walls angling outward, evokes the impression of continuing into the landscape. The entry screen reduces western sun into the living area. Cross ventilation is achieved throughout all areas.

Architects: John Wardle Architects, Melbourne, Australia

Completion: 2002

Area: 400 m²

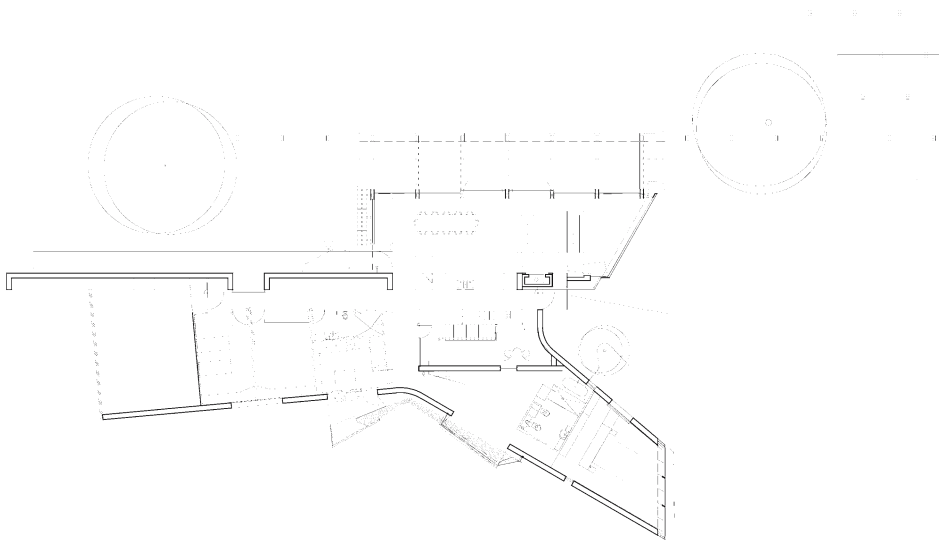





Residence, Helensville, New Zealand

This owner-built house of 180 m² area required 9 years of work. The structure was built of recycled timber, the adobes formed by hand from local soil. The floors are of earth slate or recycled timber. The glass facade enables passive solar heating. A wood fire is installed for cooking, hot water and additional heating. The property features many permaculture aspects. There is a waterless composting toilet, and a windmill pumps water to the garden.

Architects: Graeme North, Warkworth, New Zealand

Builders: Collen and John Brown

Completion: 2005

Area: 180 m²

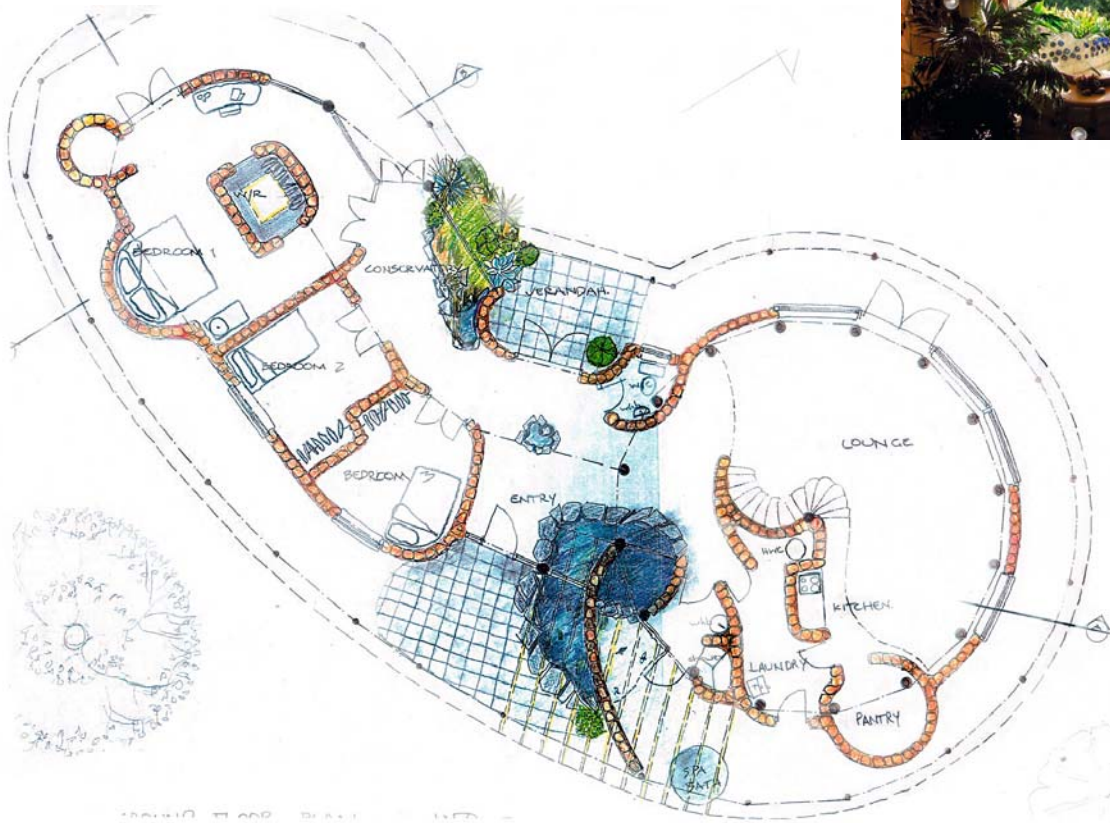





Residence, São Francisco Xavier, Brazil

The residence is situated at the foot of a mountain, on a site difficult to access. It has been built of local building materials such as earth, stone, bamboo and wood, mostly taken directly from the site. Eucalyptus trunks, formerly used as lamp posts and power poles in the city, have been recycled as posts and beams.

Architect: Maxim Bucaretschi, Brazil

Completion: 2002

Area: 330m²

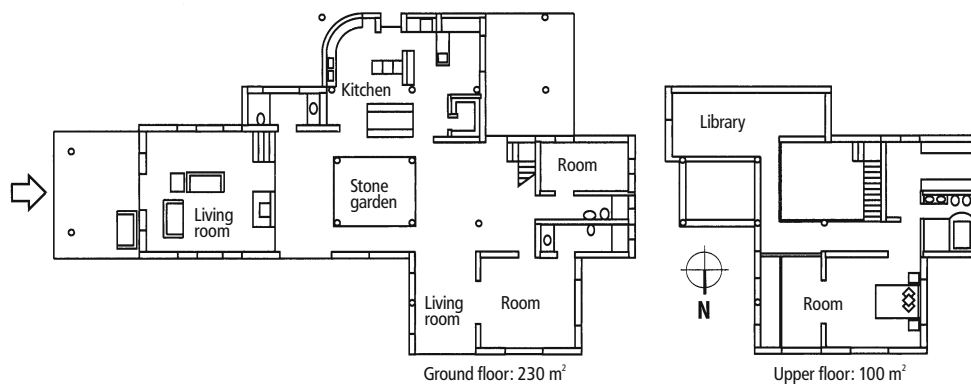





■ **Panafrican Institute for Development, Ouagadougou, Burkina Faso**

The 5,000 m² research and training centre includes three distinct groups of buildings: a teaching and administrative centre, including library and restaurant; housing for 72 students; and houses for 9 professors. All walls, vaults and domes were built from stabilised soil blocks that were manufactured from local soil on site. The vaults and the domes were erected in the Nubian technique without formwork. The exterior surfaces were plastered with a mud plaster that is stabilised with lime and cement. The project was started in 1981 and completed in 1984. In 1992 it received the Aga Khan Award for Architecture.



Architect: Philippe Glauser, Zurich, Switzerland
 Engineer: Ladjji Camara
 Financing: EZE (Evangelische Zentralstelle für Entwicklungshilfe, Bonn-Bad Godesberg), DDA (Direction de la coopération en développement et de l'Aide humanitaire, Bern), IPD (Institut Panafricain pour le Développement)

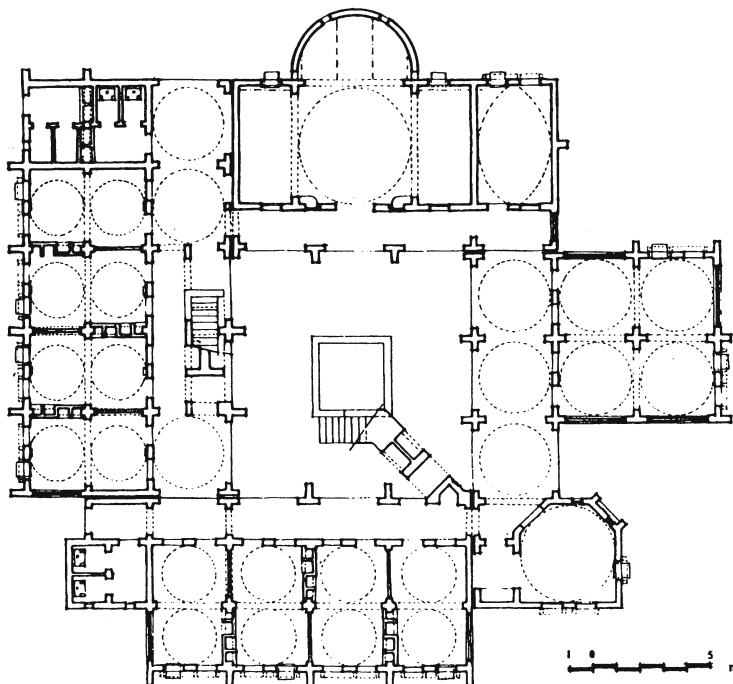

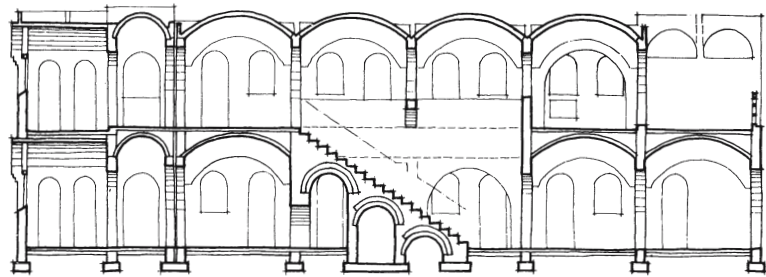
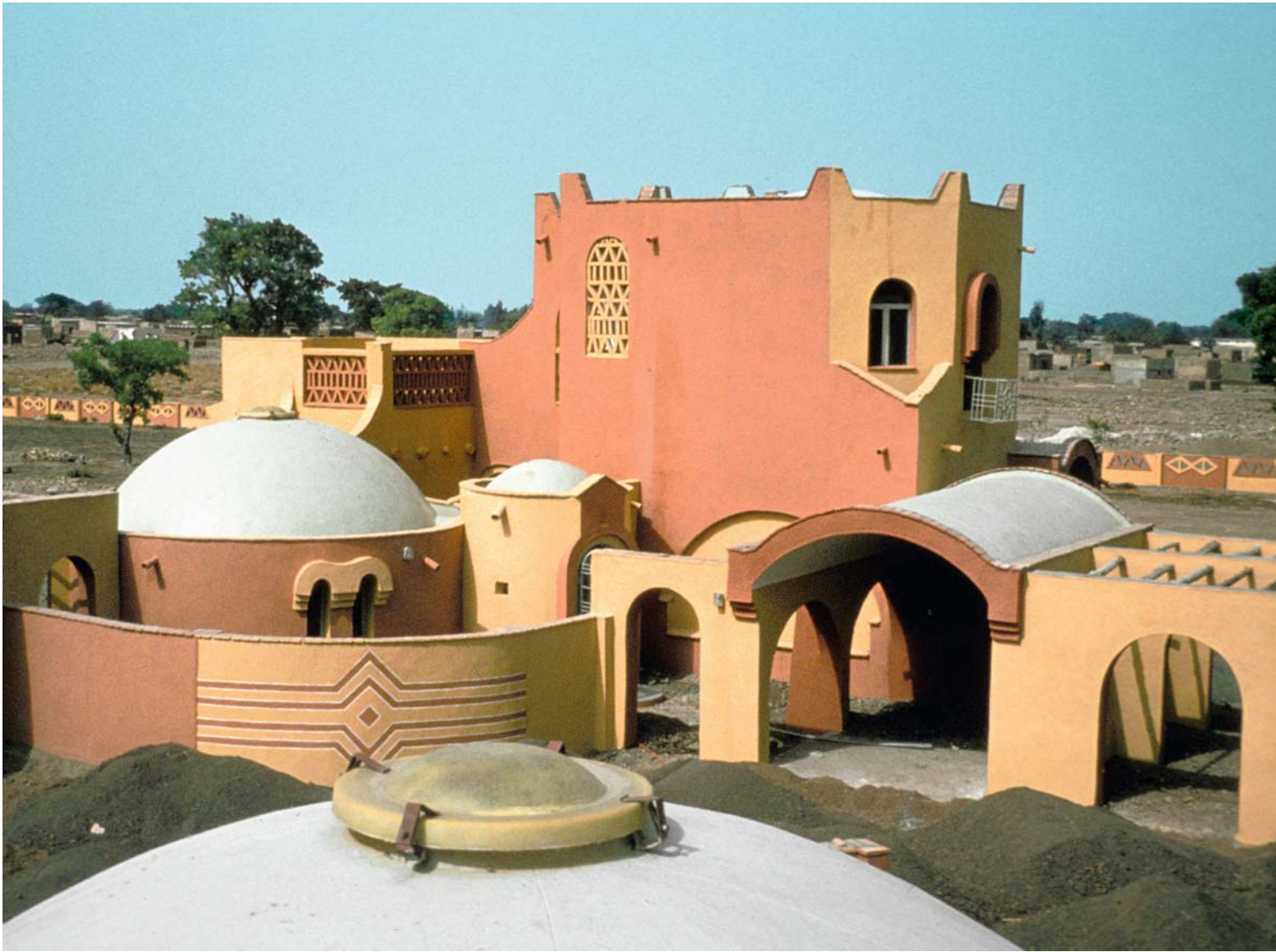

0 1 2 3 4 5 m.

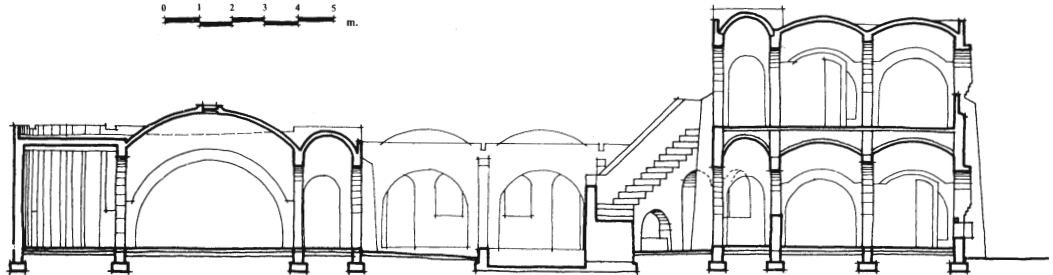



Office building, New Delhi, India

This office building was constructed in order to prove that domed and vaulted rooms built of earth blocks are conducive to a better indoor climate and can be more economical than traditional buildings with flat concrete roofs.

The project was built as part of a research and development project sponsored by the German agency Gate/GTZ.

The building provides office and laboratory space for a research group with a usable area of 115 m².

The central hall acts as a multi-purpose room for seminars, meetings and exhibitions.

The three domes were built of soil blocks, utilising a rotational slipform that was developed by the Building Research Laboratory, University of Kassel, Germany (see p. 127).

The soil blocks were produced by a manually operated press.

For heating and cooling, an earth tunnel system was installed. Climate conditions require that the rooms are cooled from April to September and heated from December to February. For this purpose, a 100-m-long stoneware pipe system was installed in a depth of 3.50 m, through which ambient air is blown by two fans. The blown air receives the nearly constant earth temperature of about 25°C, which corresponds to the annual mean temperature. This air cools the building in the hot season and heats it in the cold season.

The energy saving results in nearly 38,000 kWh per year, about $\frac{2}{3}$ of the total amount. The saving in building costs in comparison with a conventional building with flat concrete roof was 22%.

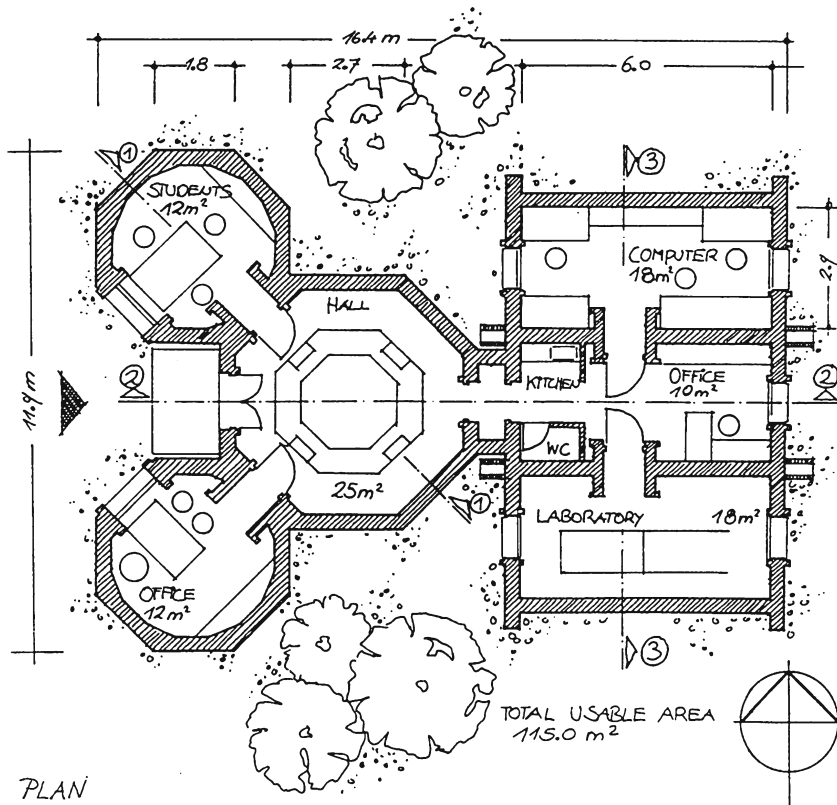

PLAN

Foundation and plinth: Burned bricks
 Vertical walls and domes: Stabilised soil blocks
 Vaults: Handmade stabilised adobes
 Surface treatment: Cowdung-mud mortar with water repellent
 Skylights: Acrylic glass with openings for natural ventilation

Architect and supervisor: Gernot Minke, Kassel, Germany
 Collaborator: R. Muthu Kumar, New Delhi, India
 Energy concept: N.K. Bansal, New Delhi, India
 Completion: 1991
 Area: 115 m²





■ School at Solvig, Järna, Sweden

The two-storey building belongs to the building complex of a Waldorf school. It contains two classrooms, each with a small entrance hall.

The basement walls are built of two layers of 15-cm-wide lightweight concrete blocks and 20 cm intervals, the cavities being filled with perlite for thermal insulation. The first floor has 50-cm-wide load-bearing walls of solid loam loafs, topped by a timber ring beam. The loafs were formed by hand from local clayey soil following the rules of the Dünne loam loaf technique, described in chapter 8.

The roof is carried by a timber frame structure, isolated by turf and covered by stone slate shingles.

The rooms are heated by open fireplaces.

Architect: Mats Wedberg, Hallstavik, Sweden

Completion: 1993

Area: 140 m²

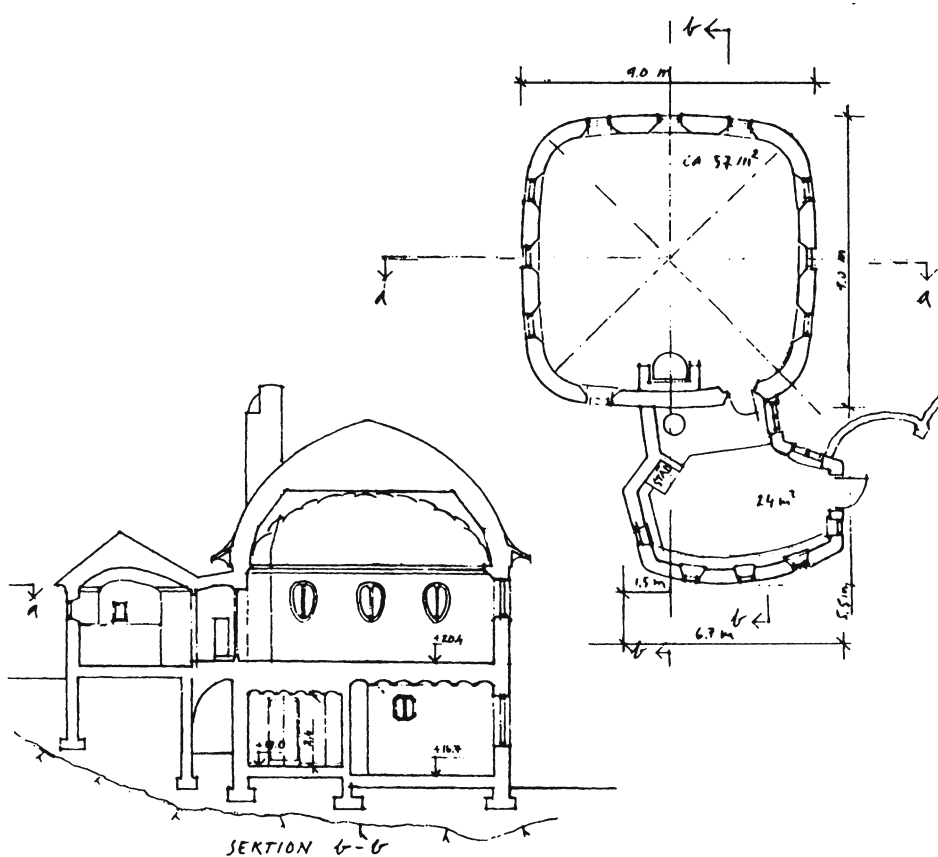





Kindergarten, Sorsum, Germany

The kindergarten has a central dome, built from loam (mud) bricks and with a free span of 10 m, over a multi-purpose hall. Its thickness is only 30 cm. Each of the three group rooms is covered with two domes which meet at a central arch. The roofs of the side rooms and corridors are formed by a timber structure. Most of the outside walls are earth-bermed. The whole building is covered by a 15-cm-thick earth layer and living grass.

The design exhibits a harmonious integration into the landscape, and the result is a highly energy-efficient building.

The earth blocks were extruded in a brick factory, and have a special rounded surface that offers positive acoustic effect in terms of sound distribution. The slight outward inclination of the blocks causes a corbelling effect, which eliminates the focusing of acoustic waves.

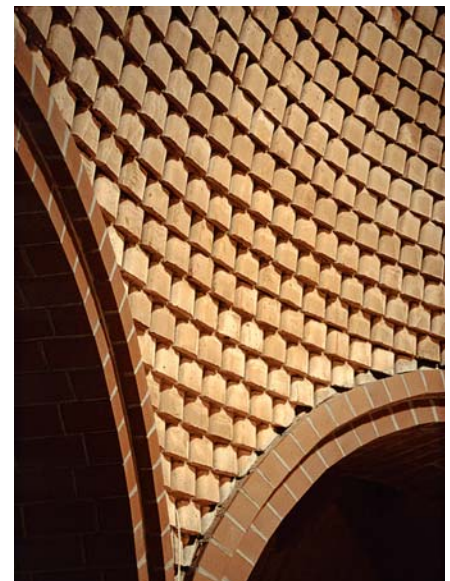
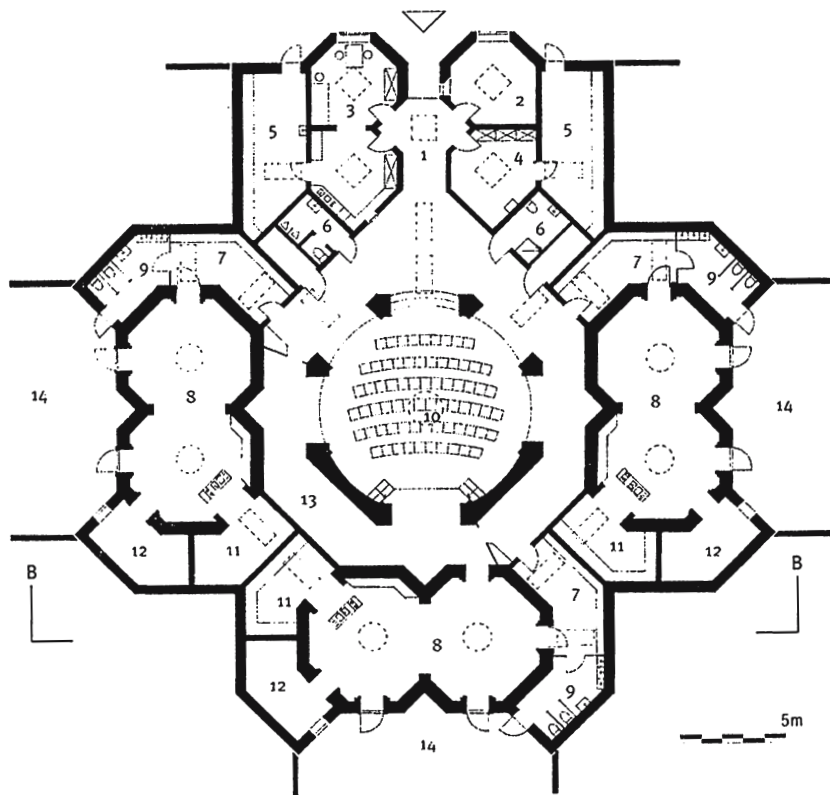

Architect: Gernot Minke, Kassel, Germany

Completion: 1996

Area: 595 m²

Exterior walls, plinth: Porous bricks

Roof: Mud brick domes; timber structure, covered by 15 cm mineral wool; water and rain proof plastic-covered fabric; 15 cm earth, wild grass vegetation.



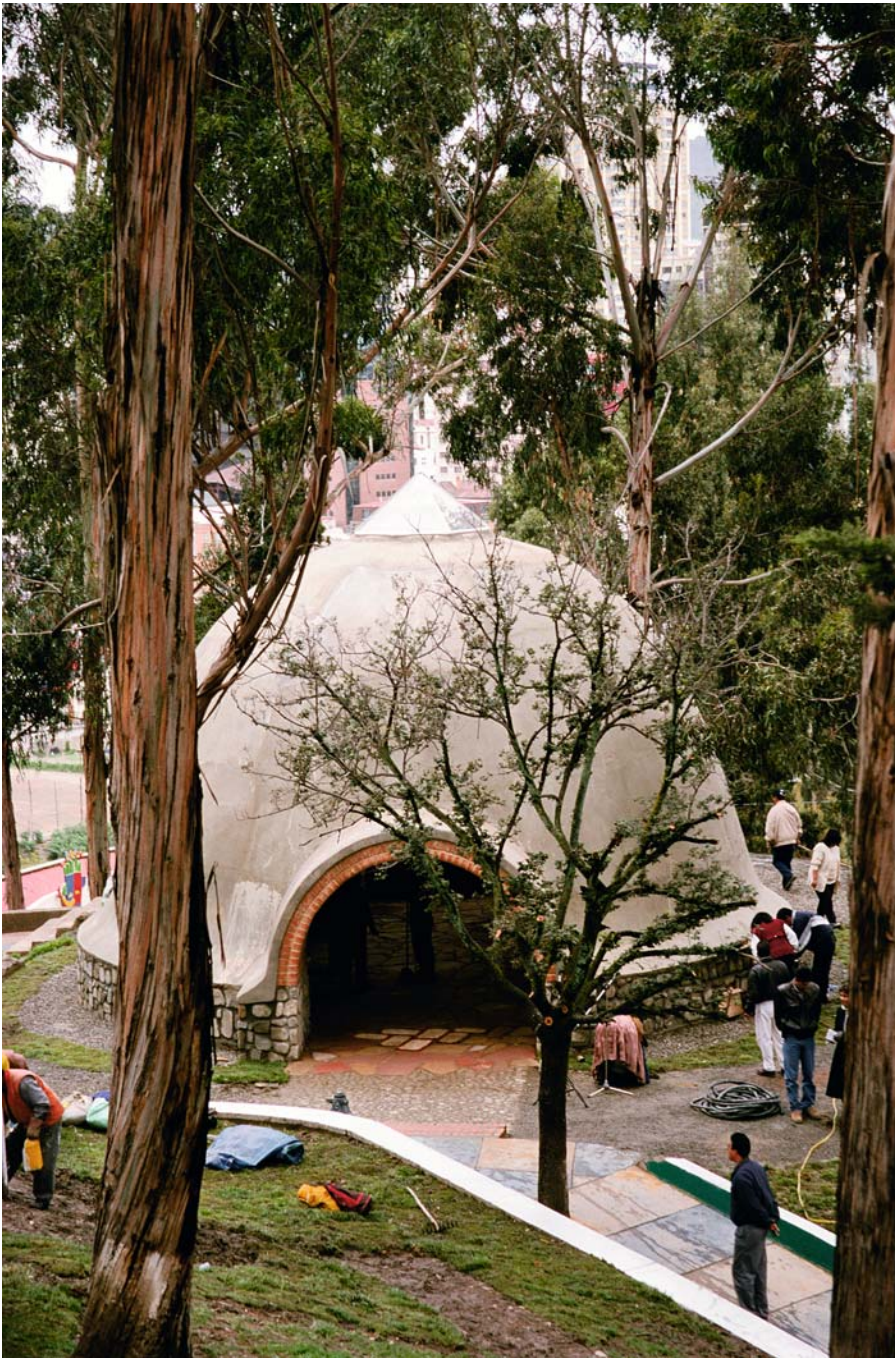

■ Cultural Centre, La Paz, Bolivia

For the Goethe Institute in La Paz, an adobe dome was erected as a multi-purpose hall for cultural events. The dome, erected without formwork and with the aid of a rotation device, has an unobstructed diameter of 8.8 m and an unobstructed height of 5.65 m. It was constructed of 9,400 specially handmade adobes. Corners were rounded for the sake of improved space acoustics. The three holes serve as grips for lighter handling, reducing weight and elevating thermal insulation. The dome is covered by fibre-glass reinforcement with a synthetic coating. The acrylic coating contains aluminium powder, which reflects ultraviolet radiation.

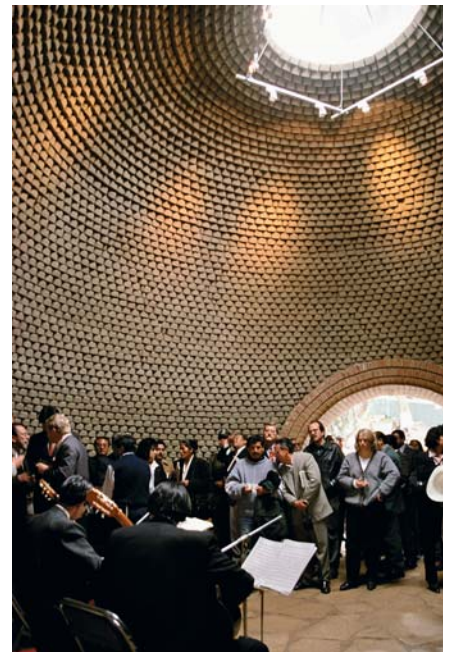

Architect: Gernot Minke, Kassel, Germany
 Supervisor: Alexander Fischer, La Paz, Bolivia
 Completion: 2000
 Area: 75 m²

■ Mosque, Wabern, Germany

Beginning in 2005, this mosque, which has two circular rooms of 9 m diameter, each covered by domes, has been under construction in the Hessian town of Wabern. It will be the first mosque to be built displaying domes and vaults of unbaked mud (green) bricks and covered by a green roof, i.e. a roof of earth and living grass. The large domes are built of special acoustic green bricks with rounded edges, as described in chapter 6, p. 68. The cross sections of the domes are optimised so that no ring forces will occur within the dome, and so that its structurally necessary thickness is only 30 cm.

Architect: Gernot Minke, Kassel, Germany
 Under construction, anticipated completion:
 2006
 Area: 273 m²

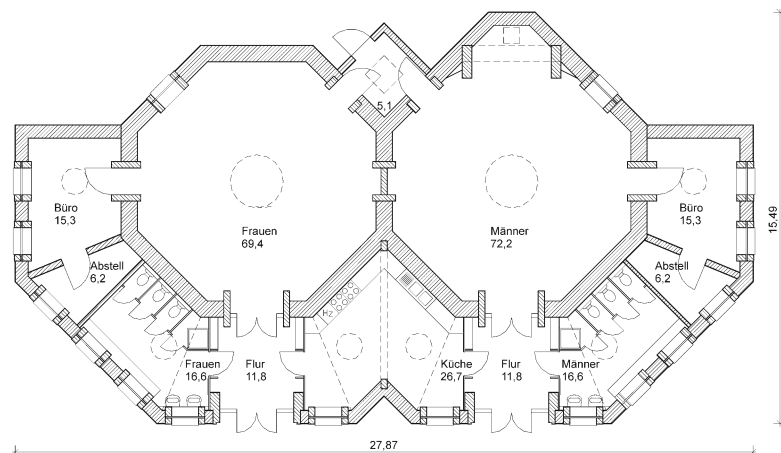
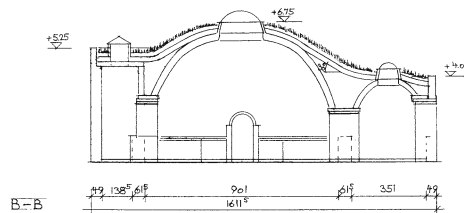
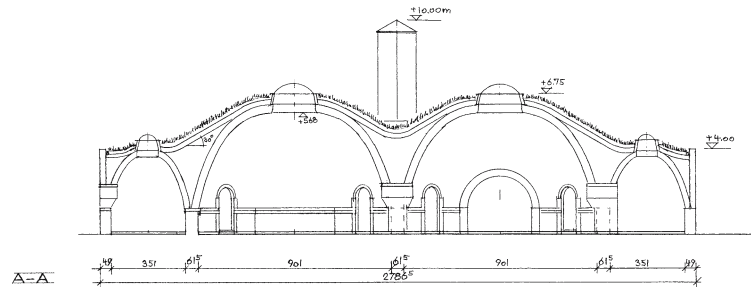
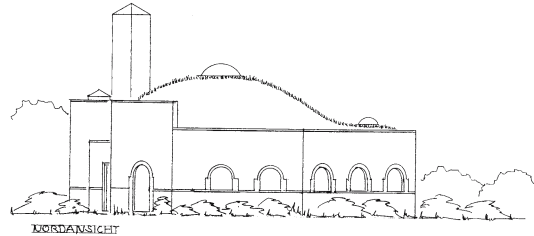
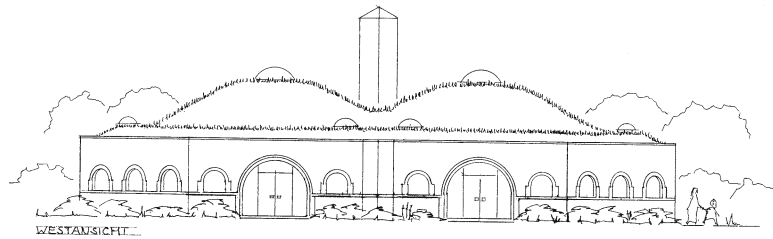



Kindergarten and Nursery of Druk White Lotus School, Ladakh, India

The Druk White Lotus School at the village of Shey in Ladakh is a large complex for 750 mixed pupils from nursery age to 18 years and includes also accommodation for some pupils and staff. Phase 1, Kindergarten & Nursery, was completed in 2001, Junior School and Administration buildings in 2004, Senior School is planned for 2008. The complex is located at an altitude of about 3700 m in an extremely cold but sunny climate.

Ventilated Trombe walls, wool as thermal insulation layer and double-glazing were used to create an acceptable indoor comfort. Key design features were also water cycle and waste management, maximised solar potential through both passive and active means, solar-assisted ventilated pit latrines and use of local building materials. The kindergarten buildings have air cavity walls on three sides with granite blocks laid in mud mortar. The roof is built in the Ladakhi tradition: a heavy mud roof supported by a timber structure independent of the walls to provide earthquake stability.



Architects and engineers: Arup Associates, London, Great Britain

Completion: 2001

Area: 596 m²

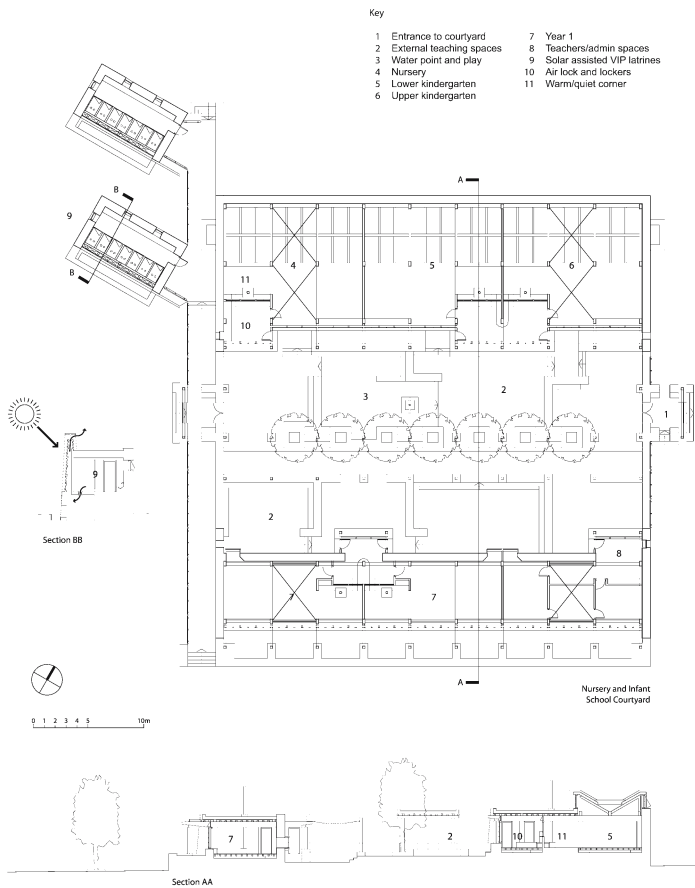



■ Mii amo Spa at Sedona, Arizona, USA

The building is a three-storeyed post-and-beam structure that is planked with diagonal buttressing sheathing. The outer walls bear an exterior lime plastering on lightweight wood wool construction slabs, behind which lies a 12-cm-thick cellulose insulation. The insides of the exterior walls consist of 20-cm-thick rammed lightweight woodchip shaving loam coated with loam plastering. The weather-exposed gable is provided with rear-ventilated larch wood sheathing. The inner walls are filled in with adobes. The brick roof and the balcony projects outward so that the southern rooms are shadowed in summer, yet admit sunlight in wintertime.





Architects: Gluckman Mayner Architects,
New York, USA
Completion: 2001
Area: 3160 m²



■ Tourist resort at Baird Bay, Eyre Peninsula, South Australia

This small ecological resort lies 100 m off the ocean on the Eyre Peninsula, 1000 km west of Adelaide in a desert climate. It provides seven bedrooms, a store and an entertainment area for tourists, who may go for swim with sea lions and dolphins. The walls of this resort, as well as the columns, retaining walls and signs, were built of rammed earth from local soil stabilised by 6% of cement.

Architect: George Grayton, Perth, Australia

Builder: Ramtec, Perth, Australia

Completion: 2005

Area: 700 m²



■ **Academic accommodation building, Charles Sturt University at Thurgoona, New South Wales, Australia**

All walls of this academic accommodation building on the campus of Charles Sturt University are built with rammed earth. Mechanical cooling ducts allow air to circulate throughout the building. There is a concrete slab floor between the first and second floors with large floor airspaces in the foyer, finally a concrete slab roof venting to mechanical vents.

Architect and builder: Terry Wright, Riverina Rammed Earth Constructions, Table Top, NSW, Australia

Completion: 2005

Area: 420 m²

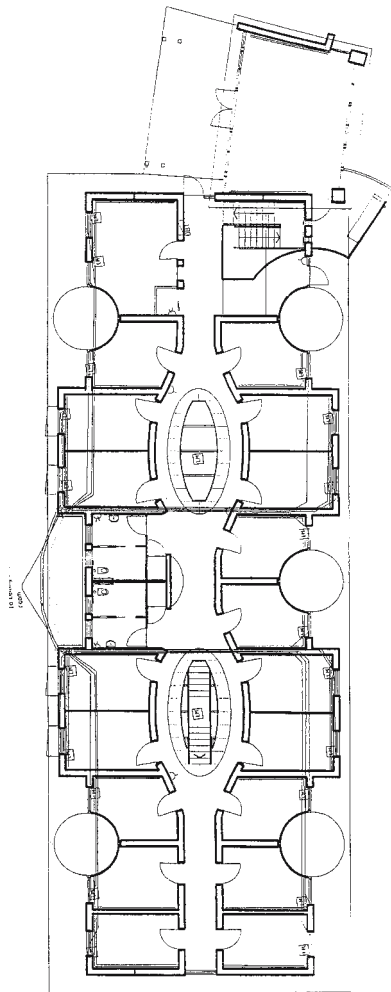

FIRST FLOOR PLAN



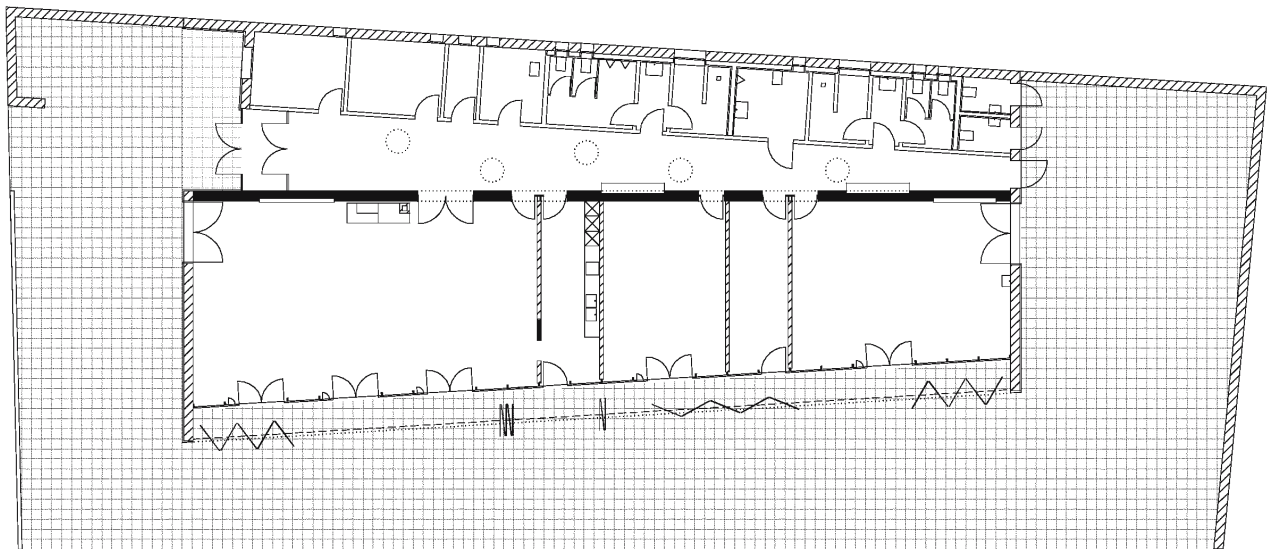

■ Youth Centre at Spandau, Berlin, Germany

This pedagogically supervised facility offers local children and young people opportunities for active leisure activities and play. A 32.5-m-long massive rammed earth wall subdivides the building and serves to conserve thermal energy and balance atmospheric humidity.

The glazed southern facade provides passive delivery of solar energy. The northern outer wall was decorated by graffiti artists with the participation of the young people. The green roof absorbs 70% of rainfall; the remainder drains off onto the adjacent site.

Architects: ask architects, Hermann Scheidt,
Frank Kasprusch, Berlin, Germany
Completed: 2005
Area: 385 m²





■ Chapel of Reconciliation, Berlin, Germany

The chapel stands at the border formerly separating West from East Berlin, on the site of the former neo-Gothic Church of Reconciliation, which was demolished by the then East German government. The interior is of oval shape, and is delimited by a rammed earth wall 7.2 m in height and 0.6 m in thickness. The roof and outer shell, formed by vertical wooden strips, represents a second oval that is eccentrically configured in relation to the first. The rammed earth wall contains large fragments of broken brick from the former church, as well as gravel, which together constitutes 55% of the material. The clay content is only 4%. This coarse-grained mixture, with a minimal moisture content of 8.1%, reduces material shrinkage to only 0.15 %. With a humidity level of 50 % and a temperature of 20°C, the equilibrium moisture content of the loam is 0.7 %. The admixture of flax fibres and intensive compaction with a tamping roller was able to produce a compressive strength of 3.2 N/mm² (measured with 20 x 20 x 20 cm cubes). The constantly changing radius of curvature required the use of an intricate special formwork.



Architects: Reitermann + Sassenroth, Berlin, Germany

Completed: 2000

Area: 315 m²

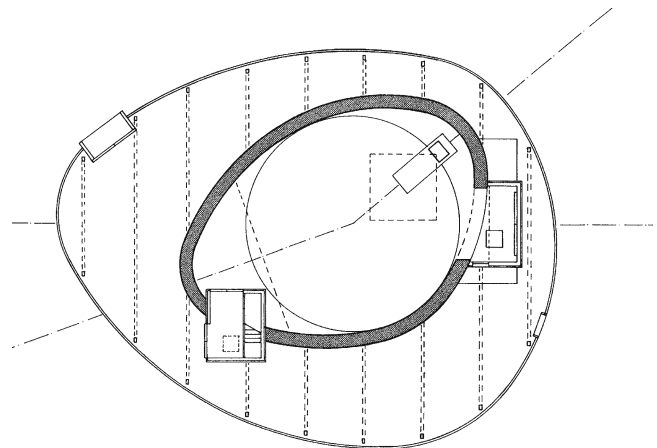
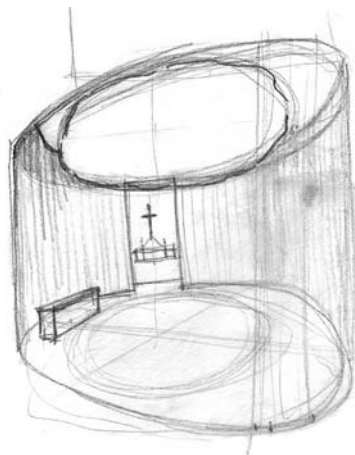





■ **Center of Gravity Foundation Hall
at Jemez Springs, New Mexico,
USA**

The building serves as the primary teaching and meditation hall for the existing Zen Buddhist compound, located in a high mountain river valley in northern New Mexico.

The thick rammed earth walls act as thermal composites, keeping unwanted summer heat out during the day and re-radiating it at night. Cantilevered roof edges block summer sun. Cooling works via cross-ventilation by opening the sliding panels to the east and the entry doors to the west. In winter heat is generated by geothermal water.

Architects: H. Predock, J. Frane, Santa Monica, CA, USA

Completion: 2003

Area: 279 m²

Future prospects

In areas with colder climates, earthen architecture may never play the dominant role it already plays in warmer regions. Owing to climatic conditions and high standards of thermal insulation in Central and Northern Europe, for example, exterior walls need additional external thermal insulation. In hot and moderate climates of all continents, on the other hand, solid external walls can be built from loam without being covered. They provide a better indoor climate and are more economical than walls made of natural stone, fired bricks or concrete.

Nevertheless we find an increasing tendency to build with loam in the cooler climates of Europe and America as well. This is due to a growing environmental consciousness and an awareness that not only do industrially produced materials require unnecessarily high energy inputs; they also consume scarce resources while producing pollution. Another factor is the desire to live in a balanced and healthy indoor environment. In developing countries, where even today, more than half of the population lives in earthen houses, modern houses are usually not built from earth but from industrialised building materials such as fired bricks, cement concrete and prefabricated panels of various compositions. Even here, there is an increasing recognition that the immense existing requirements for shelter cannot be met with industrially produced building materials and building techniques, since neither the productive capacity nor the necessary financial resources are available. The only seemingly feasible solution is to use natural, locally available materials and appropriate skills and tools while integrating self-help techniques, all of which make earth the ideal building material. In such regions, especially those with hot and moderate climates, an increasing number of modern buildings already have walls made of adobes or stabilised soil blocks. With low-cost housing in these regions, where roof structures can account for up to one third of total building costs, the use of earthen blocks for building vaults and domes is very promising, since these structural types can be more economical than industrial roofing while also creating better indoor climate by virtue of their thermal characteristics, potential for improved ventilation, and noise-insulating properties.

Newly developed and successfully tested earth construction techniques are waiting to be adapted and implemented in countries where they have not yet been tried. In order to disseminate

these techniques, guidelines should be developed and training courses offered.

The practicability of these techniques will have to be demonstrated not only with residential projects, in particular with low-cost housing, but also in public buildings such as hospitals, schools, and office buildings. This would show that, if used correctly, earth is a long-lasting and economical material that is easily available and easy to handle and is capable of creating even prestigious buildings.

The building of masonry walls from adobes, from sun-dried, unfired earth blocks, will continue to be a dominant technique simply because such techniques can be used by masons in all parts of the world without special training. Adobe domes and vaults are an economically and structurally valuable alternative to the usual flat or slightly inclined roofs of sheet metal, asbestos cement or reinforced cement concrete. They will certainly be used with greater frequency once an understanding of their potential becomes more widespread.

The rammed earth technique is favourable for moderate and warm climates, and is also economical, especially if used with adequate equipment and mechanised technology.

The knowledge of how to construct earthquake-resistant buildings of adobes and rammed earth should be disseminated throughout all earthquake-prone zones. It has been proven that in many cases, it was not the use of earthen materials as such that led to the collapse of such buildings during earthquakes, but rather incorrect structural designs and bad craftsmanship.

In industrialised countries in moderate climatic zones, prefabricated lightweight loam elements and loam plasters for interior walls will be used with increasing frequency. In Germany, Austria and the Netherlands, several types have recently become increasingly successful on the quickly growing markets for such products.

Measures

In this book, all measures as regards lengths and areas as well as physical values are based on the metric system. The Anglo-Saxon equivalent of the U-value (describing thermal conductivity in Central Europe) is the R-value, which has been added in brackets. In this context, it must be noted that the R-values are based on the metric system.

To enable readers to convert values into the imperial system that is most commonly used in North America we have listed the most important conversion factors as follows:

Lengths and areas

1 mm = 0.03937 inches

1 cm = 0.3937 inches

1 m = 39.37 inches

1 m² = 10.764 square feet

1 ha = 2.471 acres

1 inch = 2.54 cm

1 foot = 30.48 cm

1 square foot = 0.093 m²

1 acre = 0.4047 ha

Physical values

Temperature

Centigrade (Celsius) – Fahrenheit

Multiply by 9/5 and add 32

°C	°F
-10	14
0	32
10	50
20	68
30	86

R- and U-values

All R- and U-values in this book have been stated according to the metric system. For the conversion of the metric system (USI, RSI) into the respective imperial system (U, R), the use of factors is required:

$$R \times 0.1761 = \text{RSI}$$

$$\text{RSI} \times 5.6783 = R$$

U-values are the reciprocals of the respective R-values and vice versa.

USI (W/m ² K)	RSI (m ² K/W)	U (BTU/hr * sq. ft. * °F)	R (hr * sq. ft. * °F/BTU)
0.1	10	0.018	56.78
0.15	6.667	0.026	37.86
0.2	5	0.035	20.39
0.3	3.333	0.053	18.93
0.5	2	0.080	11.36
1.0	1	0.176	5.68

Bibliographical references

- Aslam, M.; Satiya, R.C.: "A Technique of Waterproofing Mud Walls." *Building Materials Note* No. 14. Central Research Institute, Roorkee, India.
- Bardou, P.; Arzoumanian, V.: *Archi de terre*. Paris, France 1978.
- Beckert, J.: "Wirkung von Verunreinigungen der Raumluft auf den Menschen," in: Beckert et al. (ed.): *Gesundes Wohnen*. Düsseldorf, Germany 1986.
- Boemans, U.: *Sanierung und Umnutzung einer Fachwerkscheune*. University of Kassel, Germany 1990.
- Bourgeois, J.-L.: "Traditional Adobe is Illegal in New Mexico," in: *Adobe Journal* No. 5/1991, p. 47.
- Cointeraux, F.: *Schule der Landbaukunst*. Hildburghausen, Germany 1793.
- CRATerre: *Construire en terre*. Paris, France 1979.
- CRATerre: *Compressed Earth Block: Production Guidelines*. GTZ, Eschborn, Germany 1991.
- Dehn, W.: "Lehmziegel der Hallstattzeit (6. Jh v. Chr.)," in: *Der Museumsfreund* No. 4/5 1964, pp. 54-61.
- Department of Housing and Construction (ed.): *Earth-wall Construction*. EBS Bulletin No. 5. Canberra, Australia 1981.
- Dalokay, Y.: *Lehmflachdachbauten in Anatolien*. Dissertation. Technical University of Braunschweig, Germany 1969.
- Elias, P.: "Le Bilan énergétique de quelques parois de bâtiment," in: *Cahier du Centre Scientifique et Technique du Bâtiment* No. 213, Oct. 1980.
- Easton, D.: *The Rammed Earth House*, White River Junction, USA 1996.
- Fathy, H.: *Natural Energy and Vernacular Architecture*. Chicago/London, USA/Great Britain 1986.
- Gilly, D.: *Praktische Abhandlung aus der Lehm-baukunst betreffend den Bau der sogenannten Lehm- oder Wellervände, wie man dieselben dauerhaft mit wenigen Kosten und einer wahren Holzersparung aufführen könne*. Berlin, Germany 1787.
- Gilly, D.: *Beschreibung einer vorteilhaften Bauart mit getrockneten Lehmziegeln*. Berlin, Germany 1790.
- Gilly, D.: *Handbuch der Land-Bau-Kunst*. Braunschweig and Halle, Germany 1800 and 1822.
- Gotthard, H.: "Über physikalische Eigenschaften des Baustoffes Lehm," in: *Naturbauweisen* 5/1949.
- Grandjean, E.: *Wohnphysiologie*. Zurich, Switzerland 1972.
- Güntzel, J.G.: *Zur Geschichte des Lehmbaus in Deutschland*. Dissertation, University of Kassel. Staufen, Germany 1988.
- Hofmann, U.; Schembra, F.W. et al.: "Die Trockenbiegefestigkeit von Kaolinen und Tonen," in: *Berichte der Deutschen keramischen Gesellschaft*, vol. 44 (1967), H.4, pp. 131-140.
- Houben, H.; Guillaud, H.: *Earth Construction Primer*. Brussels, Belgium 1984.
- Ingles, O.G.; Metcalf, J.B.: *Soil stabilisation*. Sydney, Australia 1972.
- International Labour Office (ed.): *Small-scale manufacture of stabilised soil blocks*. Geneva, Switzerland 1987.
- Jain, J.P.; Kulshrestha, R.P.; Singh, I.: *A New Technique of Making Thatch Fire Retardent*. Technical Note. Central Building Institute, Roorkee, India, 1978.
- Karsten, R.: *Bauchemie für Studium und Praxis*. Haslach, Germany (7th edition) 1983.
- Keefe, L.: *Earth Building: Methods and Materials, Repair and Conservation*. London, Great Britain 2005.
- Knöfel, D.: *Bautenschutz mineralischer Baustoffe*. Wiesbaden, Berlin, Germany 1979.
- Künzel, H.: "Die hygrothermische Beanspruchung von Außenputzen," in: *Bauphysik* (Berlin) vol. 4/1990, pp. 104-109.
- Letzner, T.; Stein, J.: *Lehm-Fachwerk*. Cologne, Germany 1987.
- Manandhar, R.: "Mud brick dome and vault construction...", in: *Proceedings of the First International Earth Sheltered Buildings Conference*. August 1-6, Sydney 1983, pp. 371-375.
- Marmé, W.; Seeberger, J.: "Der Primärenergieinhalt von Baustoffen," in: *Bauphysik* No. 5/1982, pp. 155-169 and No. 6, pp. 208-214.
- McCann, J.: *Clay and cob buildings*. Aylesbury, Great Britain 1983.
- McHenry, P.G.: *Adobe and rammed earth buildings*. New York, USA 1984.
- McHenry, P.G.: *The Adobe Story: A Global Treasure*. Albuquerque, USA 2000.
- Middleton, C.F.: *Build your house of earth*. Victoria, Australia (revised edition) 1979.
- Miller, T.; Grigusch, E.; Schulze, K.W.: *Lehm-baufibel*. Weimar, Germany 1947.
- Minke, G.: "Earthquake resistant low-cost houses utilising indigenous building materials and intermediate technology," in: *Proceedings, International Symposium on Earthquake Relief in Less Industrialized Areas*. March 28-30, 1984. Zurich, Switzerland 1984.
- Minke, G.: "Design and Construction of Energy and Cost Saving Vault and Dome Structures," in: *Proceedings of the International Symposium of Hassan Fathy for Architecture for the Poor*, April 20-22, 1993. Cairo, Egypt 1993.
- Minke, G.: "Humidity Control/Balancing humidity fluctuations," in: Bansal, Hauser, Minke: *Passive Building Design, A Handbook of Natural Climatic Control*. Amsterdam, Netherlands 1994, pp. 180-188.
- Minke, G.; Mukerji, K.: *Structurally Optimized Domes – A Manual of Design and Construction*. Braunschweig, Germany 1995.
- Minke, G.: *Earth Construction Handbook*. Southampton, Great Britain 2000.
- Minke, G.: *Das neue Lehm-bau-Handbuch*. Staufen, Germany (6th edition) 2004.
- Minke, G.: *Construction manual for earthquake-resistant houses built of earth*. Eschborn, Germany 2002.
- Minke, G.; Mahlke, F.: *Building with Straw*. Basel, Berlin, Boston, Germany 2005.
- Möhler, K.: "Grundlagen der Holzhochbaukonstruktionen," in: Götz, K.-H.J.; Hoor, D et al.: *Holzbauatlas*. Munich, Germany 1978.
- Mukerji, K.: *Soil Block Presses*. GTZ, Eschborn, Germany 1986.
- Mukerji, K.: *Soil Block Presses: Product Information*. GTZ, Eschborn, Germany 1988.
- Niemeyer, R.: *Der Lehm-bau und seine praktische Anwendung*. Hamburg, Germany 1946.
- OECD, Nuclear Energy Agency: "Exposure to Radiation from Natural Radioactivity in Building Material," in: *Report, May 1979*. Paris, France 1979.
- Oliver, M.; Mesbah, A.: "The earth as a material," in: *Proceedings International Symposium on Modern Earth Construction*. Peking, China 1985.
- Pingel, M. and P.: *Bericht über den Anstrich der Lehmkuppeln ihres Hauses in Auroville, Indien*. Unpublished document. 1993.
- Popposwamy, G.: *Rural India. Village Houses in Rammed Earth*. Stuttgart, Germany 1979.
- Pumpelly, R. (ed.): *Explorations in Turkestan*. Washington, USA 1908.
- Rauch, M.; Kapfinger, O.: *Rammed Earth / Lehm und Architektur / Terra cruda*. Basel, Berlin, Boston, Germany 2001.
- Schmitt, C.: *Leichtlehm-bau*. BPS-I Report, unpublished document. University of Kassel, Germany 1993.
- Schreckenbach, H.: *Construction Technology for a tropical developing country*. Eschborn, Germany no date.
- Smith, R.G.; Webb, D.T.J.: *Small Scale Manufacture of Stabilized Soil Bricks*. Technical Memorandum No. 12. International Labour Office. Geneva, Switzerland, 1987.
- Sibtain, S.N.: *To build a village – earthquake-resistant rural architecture*. Parramatta, Australia 1982.
- Stulz, R.; Mukerji, K.: *Appropriate Building Materials*. St. Gallen, Switzerland 1988.

Turowski, R.: *Entlastung der Rohstoff- und Primärenergiebilanz ...* Dissertation, University of Essen, Germany 1977.

United Nations Centre for Human Settlements (ed.): *Earth Construction Technology*. Nairobi, Kenya 1992.

Volhard, F.: *Leichtlembau*. Karlsruhe, Germany 1983.

Vorhauer, K.: *Low Cost/Self Help Housing*. Gate Modul 6/6. Eschborn, Germany 1979.

Voth, B.: *Boden, Baugrund und Baustoff*. Wiesbaden/Berlin, Germany 1978.

Walker, P.; Keable, R.; Martin, J.; Maniatidis, V.: *Rammed earth: design and construction guidelines*. BRE Press, Bracknell, Great Britain 2005.

Wehle, K.: *Werkstoffe und Techniken der Malerei*. Ravensburg, Germany (5th edition) 1985.

Weiss, A.: *Angewandte Chemie* 75 (1963), pp. 755-762.

Weller, K.; Rehberg, S.: *Lösungsansätze für den energie- und rohstoffsparenden Wohnungsbau*. DFG research project, Technical University of Berlin, Germany 1979.

Yazdani, H.: *Erhöhung der Lebensdauer von Lehmbauten in erdbebengefährdeten Gebieten Afghanistans*. Dissertation, University of Kassel, Germany 1985.

Zogler, O.: *Wohnhäuser aus Lehm*. Munich, Germany 2004.

Acknowledgements

The author wishes to thank all students, assistants and colleagues, who have contributed to the research and development projects in Germany, Argentina, Bolivia, Brazil, Chile, Guatemala, Ecuador, Hungary, India, Nigeria and Russia. It is owing to these efforts that this book contains so much data and accounts of practical work experience.

Special thanks are due to the research assistants H. G. Merz, Ulrich Merz, Klaus Eckart, Ulla Lustig-Rössler, Kiran Mukerji, Ulrich Boemans, Uwe Jaensch, Dittmar Hecken, Alexander Fischer, Arno Reich-Siggemann, Friedemann Mahlke, Marcio Rosa d'Avila, Ernst Müller, Saskia Baden and the technician Frank Millies, who built most of the newly developed test apparatuses and construction devices.

The author also wishes to thank Pawan Kumar and Anke Lubenow, who helped in making the drawings; Ulrich Boemans, Sigrid Köster, Uwe Jaensch and Friedemann Mahlke, who prepared the computer graphics; Gabrielle Pfaff, who designed the layout; as well as Shalini Hingorani, Rajeshwari Prakash, Sanjay Prakash and Ian Pepper for their assistance with the translation. Last but not least, the author expresses his gratitude to Ria Stein and Michael Wachholz, who provided editorial assistance and conducted image research.

Kassel, February 2006
Gernot Minke

Illustration credits

Adle, Kamran (Aga Kahn Award for Architecture):
p. 175 top and bottom

Atlas-Copco: 5.11

Anderson, Ken: p. 166

Bochow, K.-H.: 6.3

Breshna: 14.30

Bucaretschi, Maxim: p. 172 left and right; p. 173 top and bottom

CEPED: 5.26

Consolid: 6.14

Dressler, F.: 8.8

Dufter, S.: 7.1, 7.2

El Badwan, G.: 14.29

Enchantment Resort (Mii Amo): p. 187 top

Fischer, Alexander: p. 160 top and centre

Gerster-Rapho: 1.6

Glauser, Philippe: p. 174 top

Gnädinger, Alexander: cover

Gruner, D.: 1.4

Heuser: 5.12

Huber, Samuel: 192 top

Karcher, Joaquin: p. 162 top, centre right and left; p. 163; p. 164 top, centre right and left; p. 165

Klomfar, Bruno: 192 bottom, 193

Lauber, Wolfgang: 1.9

Lorenz-Ladener, C.: 6.4

Lukas, G.: 8.9, 8.10

Mein, Trevor: p. 168 top, centre right and left; p. 169 top and bottom

North, Graeme: p. 170 top and centre left; p. 171

Nothelfer, Michael: p. 158 top, p. 159 top, bottom right and left

OKOKOK Productions: p. 157 top, bottom right and left

Oliver, D.: 5.22, 5.23

Pacific Adobe: 6.15

Payne, Alan and Trish: p. 188 top, centre right and left, bottom

Predock, Jason: p. 194 top; p. 195

Reynolds, M.: 14.4

Schijns, W.: 14.25

Sohie, Caroline: p. 184 left and right; p. 185 top and bottom right

Süß, Andreas: p. 190 top; p. 191 top and bottom

Trappel, Ray: p. 167 top and bottom

Weller, K.: 6.16, 6.17

Wolf, S.: 5.27, 5.28

Wright, Anthony: p. 189 top and bottom

Yazdani, S.: 1.5, 14.54, 14.55

Zernike, Harry: p. 186 top and bottom, p. 187 bottom right

All other images: Minke, Gernot

Graphic design: Gabrielle Pfaff, Berlin
Translation: Shalima Hingorami, Rajeshwari
Prakash, Sanjay Prakash, New Dehli, India;
Ian Pepper, Berlin, and Gernot Minke, Kassel,
Germany

A CIP catalogue record for this book is available
from the Library of Congress, Washington D.C.,
USA

Bibliographic information published by
Die Deutsche Bibliothek
Die Deutsche Bibliothek lists this publication in the
Deutsche Nationalbibliografie; detailed biblio-
graphic data is available in the internet at
<<http://dnb.ddb.de>>.

This work is subject to copyright. All rights are
reserved, whether the whole or part of the mate-
rial is concerned, specifically the rights of transla-
tion, reprinting, re-use of illustrations, recitation,
broadcasting, reproduction on microfilms or in
other ways, and storage in data banks. For any
kind of use, permission of the copyright owner
must be obtained.

© 2006 Birkhäuser – Publishers for Architecture,
P.O. Box 133, CH-4010 Basel, Switzerland
Part of Springer Science+Business Media
Printed on acid-free paper produced
from chlorine-free pulp. TCF ∞

Printed in Germany
ISBN-13: 978-3-7643-7477-8
ISBN-10: 3-7643-7477-2

9 8 7 6 5 4 3 2 1 <http://www.birkhauser.ch>

Front cover: Chapel of Reconciliation, Berlin,
Germany